



**HD-Analoog Noise Remover**  
**SC-NRC01MA**

**Gebruikershandleiding (E)**



[ SC-NRT01MA ]



[ SC-NRR01MA ]

## **Safety Warnings and Cautions**

This is to protect user safety and prevent property damage.

Please read it carefully and use it correctly.

### ***Warning (If this is not observed, the user may be killed or seriously injured.)***

- Do not leave the device in a place where water may drip or splash, and do not place anything filled with water, such as a vase, on top of the product.
- Do not bend the power cord forcibly or damage it by being pressed by a heavy object.
- Do not pull out the power cord forcibly or insert or unplug the power plug with wet hands, and do not plug in the power plug if the power plug is loose.
- Place the product in a cool place out of direct sunlight, maintain an appropriate temperature, and avoid heat sources such as candles and heaters. Also, keep equipment and tools away from places where people come and go.
- Pay attention to possible hazards in the work area, such as damp floors, ungrounded power extension cables, old power cords, and lack of safety grounding, and contact the place of purchase or a professional in case of any problems.
- For the operation of this device, the voltage fluctuation range must be within 10% of the specified voltage, and the power outlet must be grounded. Also, do not use electric appliances such as hair dryers, irons, and refrigerators together with the outlet to which the power connector is connected. -It may cause abnormal heat, fire or electric shock.

### ***Caution (Failure to observe this may result in personal injury or property damage.)***

- If this device is used adjacent to equipment that generates strong radio waves such as walkie-talkies (TRANCEIVER, walkie-talkie, etc.) or repeaters, it may affect the video signal and cause abnormalities such as noise or screen breakage. , Do not use as it may cause equipment failure.
- It is recommended that the ambient temperature and humidity be appropriate.
- Install on a flat and stable place, and do not use it vertically or at an angle.
- Be careful when using as strong shocks or vibrations can cause device failure.
- Be sure to connect the power cord to a grounded outlet.
- Place the power plug in an easily accessible place.
- Transmission distance may differ depending on the type of coaxial cable.
- When thunder or lightning strikes, please be careful of safety and disconnect the power plug.
- Insulate the part where the cable is connected with the connector so that the metal part is not exposed.
- When extending or terminating a coaxial cable, be sure to connect it in the following way.
  - BNC-M (male) - BNC-JJ - BNC-M (male): BNC connector connection example



- For problems or questions other than the above, refer to the user manual and if you need help from a professional engineer, contact our A/S center.

## 1. Product introduction



### 1-1. Summary

SC-NRC01MA is a device that modulates HD-Analog video signals and UTC signals, which are command signals, into noise-resistant signals and transmits them. For convenience of installation, video input/output is harnessed, and the transmitter has a separate power accessory, making it convenient for installation.

### 1-2. Product Features

- Long-distance transmission of video signals is possible.
- Noise canceling function.
- UTC function support for controlling the camera
- Supports various input signals. (AHD 2M/4M, TVI 2M)
- Use of a small case.
- Built-in surge protection circuit

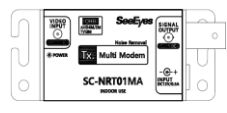
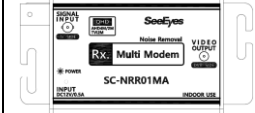
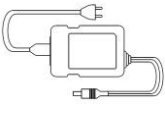
## 2. product composition

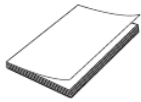
SC-NRT01MA	SC-NRR01MA	DC 12V Adaptor	DC lead wire	User Manual
				

## 3. Names and functions of each part

### 3-1. SC-NRT01MA(For camera side)

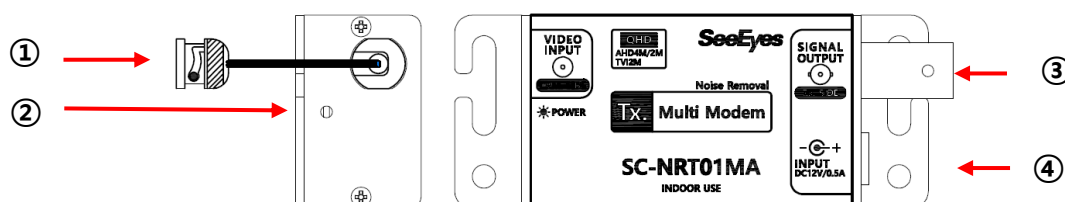

- ① VIDEO INPUT: HD-Analog video input terminal (AHD 2M/4M, TVI 2M)
- ② POWER LED: RED LED lights up when power is supplied.
- ③ SIGNAL OUTPUT: Connected to the SIGNAL INPUT terminal of 'SC-NRR01MA' (coaxial cable connection)
- ④ POWER IN: DC 12V power input terminal

### 3-2. SC-NRR01MA(For DVR side)

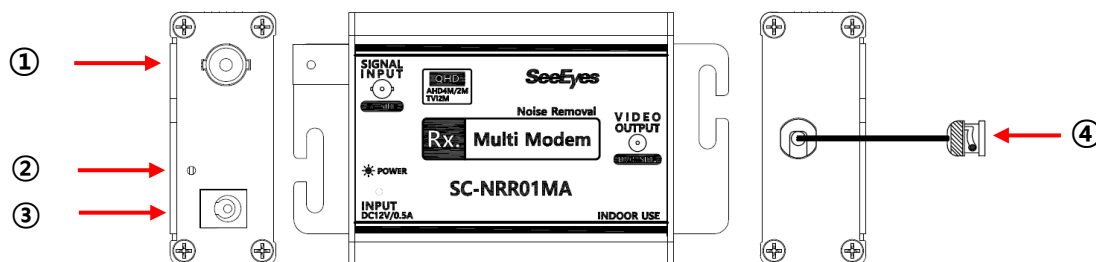

- ① SIGNAL INPUT: Connected to the SIGNAL OUTPUT terminal of 'SC-NRT01MA' (coaxial cable connection)
- ② POWER LED: RED LED lights up when power is supplied.
- ③ POWER IN: DC 12V power input terminal.
- ④ VIDEO OUTPUT: HD-Analog video output terminal

### 4. Product configuration example

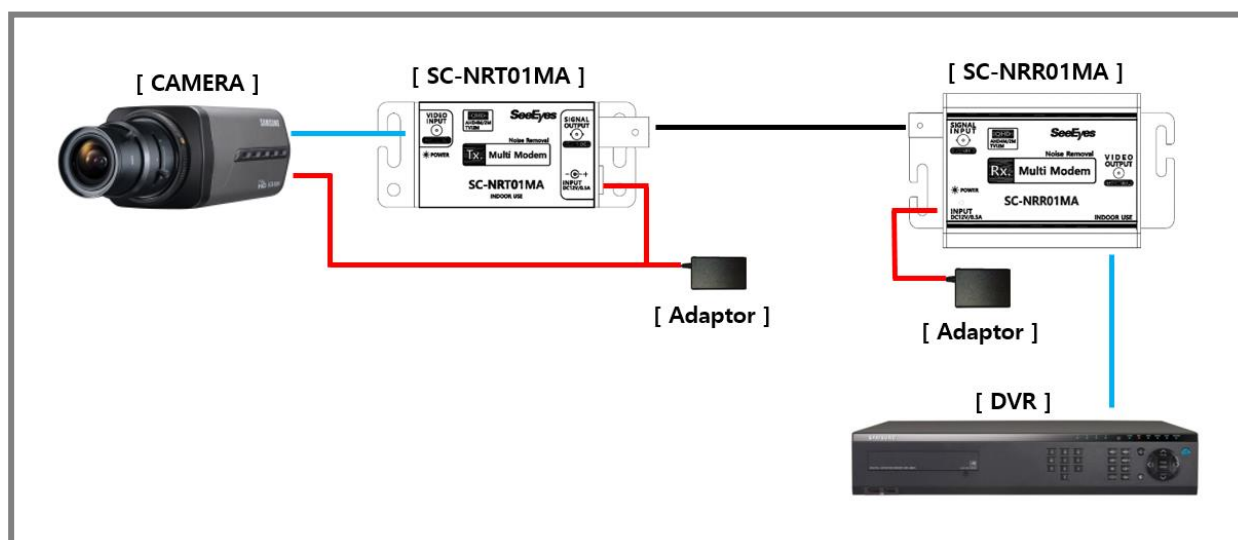

#### ※ Transmission distance by cable type

Manufacturer	Cable Type	Distance(m)
Kumkang	5C-HFBT	700
U-JIN	RG-58U	250
U-JIN	RG-59U	400
CANARE	L-5C2V	400
CANARE	L-3C2V	300

※ Transmission distance may differ depending on the cable manufacturer and connection status.

※ Be sure to connect the coaxial cable joint as follows.

- BNC-M (male) - BNC-JJ - BNC-M (male): BNC connector connection example



## 5. Troubleshooting method

Symptom	Check method
<b>PWR LED is off</b>	<ul style="list-style-type: none"> <li>• Check that the adapter's AC power cord is properly connected.</li> <li>• Make sure the DC 12V adapter is connected.</li> </ul>
<b>No Video</b>	<ul style="list-style-type: none"> <li>• Check that the power cable is properly connected.</li> <li>• Make sure the cable transmission distance is acceptable.</li> <li>• Check the cable connections.</li> <li>• Check whether the camera and DVR are compatible.</li> </ul>
<b>Noise on the video</b>	<ul style="list-style-type: none"> <li>• Make sure the cable transmission distance is acceptable.</li> <li>• If there are wireless devices such as repeaters nearby, please, install it somewhere.</li> <li>• Check the cable connections.</li> </ul>
<b>No UTC</b>	<ul style="list-style-type: none"> <li>• This product is a UTC supported product.</li> <li>• When connecting the DVR and camera directly without applying a transmitter, check if it operates normally.</li> <li>• The signals and protocols between the camera and DVR must be properly set.</li> <li>• Errors may occur with some specific cameras and DVRs.</li> </ul>

## 6. Product specification

		SC-NRT01MA	SC-NRR01MA
<b>Input signal</b>		AHD: 2M/4M, TVI: 2M	70MHz, RF modulated signal
<b>Output signal</b>		RF modulated signal	AHD: 2M/4M, TVI: 2M
<b>Input power</b>		DC12V, Apply camera adapter	DC12V, 0.5A Adaptor
<b>UTC(camera control)</b>		Supported	
<b>Transmission distance</b>		5C-HFBT: 700m (Made by KumKang) *	
<b>Connection Terminal</b>	<b>Signal input</b>	Video input: BNC Male Harness	RF input : BNC Female
	<b>Power input</b>	DC-JACK	DC-JACK
	<b>Signal output</b>	RF output: BNC Female	Video output: BNC Male Harness
<b>Power consumption</b>		DC 12V/80mA	DC 12V/130mA
<b>LED</b>		RED ON: Power ON, OFF: Power OFF	
<b>Temperature / Humidity</b>		-10°C ~ +50°C / 0 ~ 80%	
<b>Material / Weight</b>		Aluminum / 60.8g	Aluminum / 122.5g
<b>Dimensions</b>		85.6 (W) x 33(H) x 21.5(D) mm	103(W) x 60(H) x 25(D) mm

※ Transmission distance may vary depending on cable characteristics.

## 7. Product Warranty

product name		
model name		
date of purchase		
place of purchase		
client	name	
	Address and contact information	
store	name	
	Address and contact information	
Warranty	Within 2 years after purchase	

Any malfunctions occurring under normal handling conditions for two years after purchase will be repaired free of charge.

For repairs, please call the phone number indicated on the cover of the instruction manual.

When reporting a malfunction, please inform us of the model name of the product and the condition of the failure and contact the person in charge.

It is convenient to know your affiliation and name.

Please read this user manual carefully before reporting a malfunction.

The shape and circuit of the product are subject to change without notice for performance improvement.

**Failures according to the following items will be handled for a fee.**

- **Failure due to user's careless handling**
- **When connecting a power other than the rated power**
- **In case of disassembly or repair by the user**
- **When replacing consumables**
- **Failure due to natural disasters (lightning, fire, flood, tsunami, etc.)**



---

Gedistribueerd door:

VSS Nederland B.V. | Telfordstraat 11m | 8013 RL | Zwolle | T.038 - 428 9 420 | [info@vssnederland.nl](mailto:info@vssnederland.nl) | [www.vssnederland.nl](http://www.vssnederland.nl)

---