



EN

# User Manual

**1/2.8" HD Dome, Fixed, Indoor,  
Day&Night, 1920x1080, Infrared,  
2.7-13.5 mm, 12VDC**

**MPD-62V2713P0A**



# Safety Precaution

- To prevent fire or shock hazard, do not expose the unit to rain or moisture.
- To prevent electric shocks and risk of fire hazards, do NOT use other than specific power source.

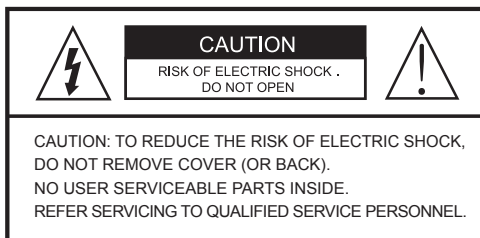

The symbol is intended to alert the user to the presence of uninsulated "dangerous voltage" within the product's enclosure that may be of sufficient magnitude to constitute a risk of electric shock to persons.



The symbol is intended to alert the user to the presence of important operating and maintenance(servicing) instructions in the literature accompanying the unit.

## • Warning :

This equipment has been tested and found to comply with the limits for a Class A digital device, pursuant to part 15 of the FCC Rules. These limits are designed to provide reasonable protection against harmful interference when the equipment is operated in a commercial environment. This equipment generates, uses, and can radiate radio frequency energy and, if not installed and used in accordance with the instruction manual, may cause harmful interference to radio communications. Operation of this equipment in a residential area is likely to cause harmful interference in which case the user will be required to correct the interference at his own expense.

## • Caution :

Any changes or modifications in construction of this device which are not expressly approved by the party responsible for compliance could void the user's authority to operate the equipment.

Mains power quality should be that of a typical commercial environment. If the user of the model requires continued operation during power mains interruptions, it is recommended that the model be powered from an uninterruptible power supply (UPS) or a battery.

# Safety Precaution

---

 **NOTICE**

- The image used in this instruction manual are processed to help comprehension and may differ from actual video of the camera.
- Avoid installing areas where has shock or vibration which results in the problems.
- Pay attention to safety when laying the connection cable and observe that the cable is not subjected to heavy loads, kinks or damage and no moisture can get in.
- Never open the device such as boards or lens.  
The warranty becomes void if repairs are undertaken by unauthorized persons.
- Maintenance and repair have to be carried out only by authorized service centers.
- Use only a mild detergent to clean the housing.
- The camera should never be operated beyond the technical specifications.  
This can lead to destruction.
- The camera should never be operated in water.

# Contents

---

p.03~04

Safety Precaution

p.05

Contents

p.06

Features

p.07

Composition

p.08

Dimensions

p.09

Part Names

p.10~12

Installation Instructions

p.13~30

Operating Instructions

p.31~32

Specifications

# Features

---

## Key Features

- 1/2.8" SONY Exmor CMOS sensor
- 1080P TVI mode, CVI mode, AHD Video or 960H CVBS Video Selectable
- TVI mode/CVI mode/AHD Video Transmission Distance over Coax.; 500M
- Automatically removable IR Cut filter by Dual filter switcher
- Built-in f=2.7~13.5 mm F1.3 Mega pixel DC Auto Iris Vari-focal lens
- Sensitivity of Color 0.3 Lux / BW 0.005 Lux (@IRE 40, Sens-up On, IR Off)
- D-WDR (Wide Dynamic Range)
- Improved noise reduction 2D+3D-NR(TVI mode/CVI mode/AHD), 2DNR(CVBS)
- FOCUS ASSIST for Error free focus adjustment
- 2 Auto(AE/AWB) control
- LSC (Lens Shading Compensation)
- DPC (Defective Pixel Compensation)
- Motion detection, Privacy mask, BLC/HSBLC, Defog, Sens-up(~x30), Mirror/Flip, Freeze, Negative Image, IR Smart, Cam Title
- Built-in 2pcs High power SMD LED
- OSD MENU & CVBS output for easy installation & maintenance
- Circuit protection against faulty connection in power polarity
- Zoom & Focus Adjustment on 3-Axis gimbal
- Double side Anti-scratch Hard coated bubble dome
- Quick installation with Easy Adaptor (Flat or Tilted Adaptor)
- Power: DC12V

# Composition

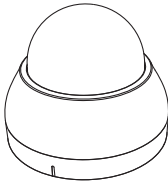

Dome Camera

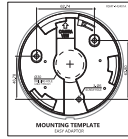

Mounting Template



Operating Instruction

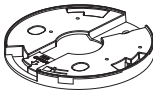

Easy Adaptor  
(Flat type)

Plastic Anchor:  
6 x 30mm (3pcs)



Mounting Screw:  
3.5 x 25mm (3pcs)



Open & Adjust  
Driver (1pc)

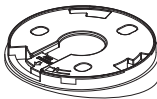
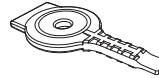

Easy Adaptor  
(Tilted type)

Video Sub-out Cable

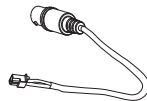

# Dimensions

(unit : mm)

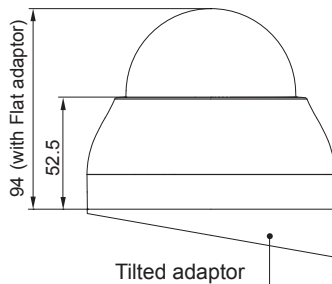
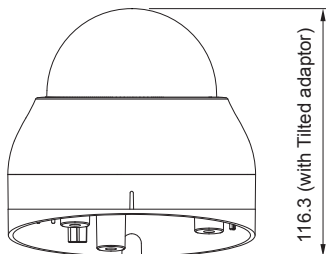
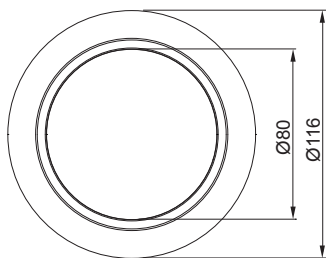

## CAUTION

- Extreme care should be taken NOT to scratch the bubble dome surface while the camera installing or adjusting.
- Care should be taken the cable is NOT to be damaged, kinked or exposed in the hazardous area.
- Do not expose the camera directly to a strong light source such as the sun or spot light.



# Part Names

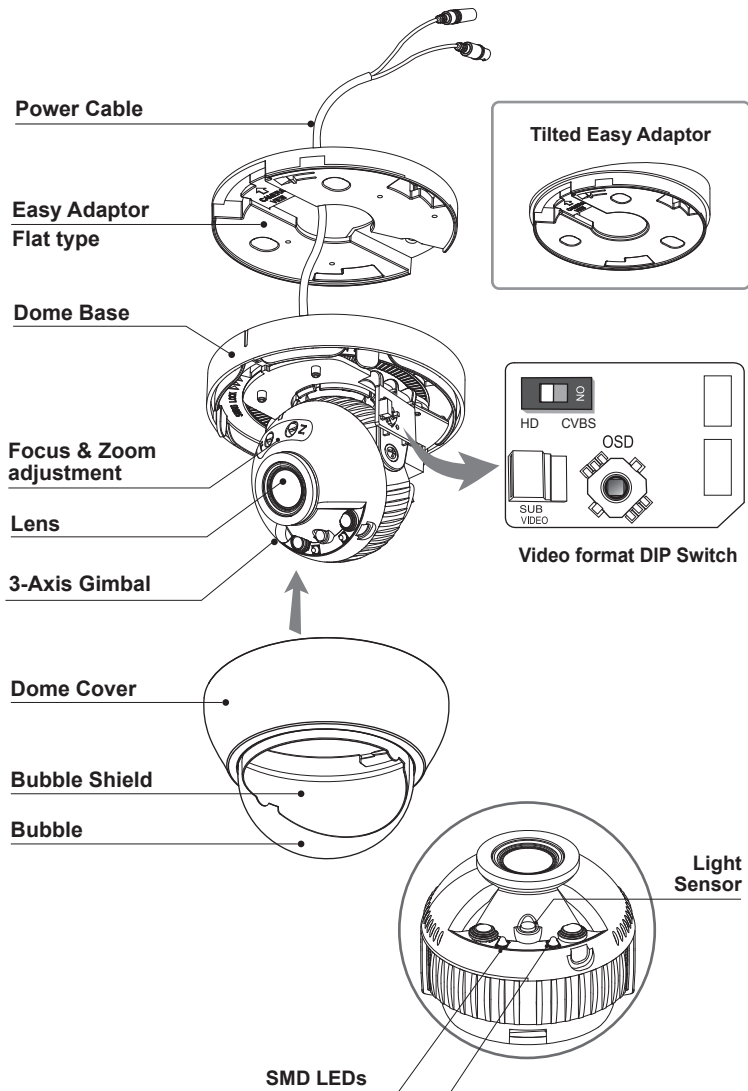

# Installation Instructions

1. Drill three holes for mounting on the ceiling or wall.
2. Place the Easy Adaptors at the pre-drilled installation position and fix it by using mounting screws.
3. Route the power/video cable to the connecting place.
4. Attach the dome base assembly to the Easy Adaptor.
5. Adjust the camera's viewing angle (Pan, Tilt, Rotation)  
(Then remove the caution sticker. Refer to p.11)
6. Assemble the dome cover to the dome base unit.

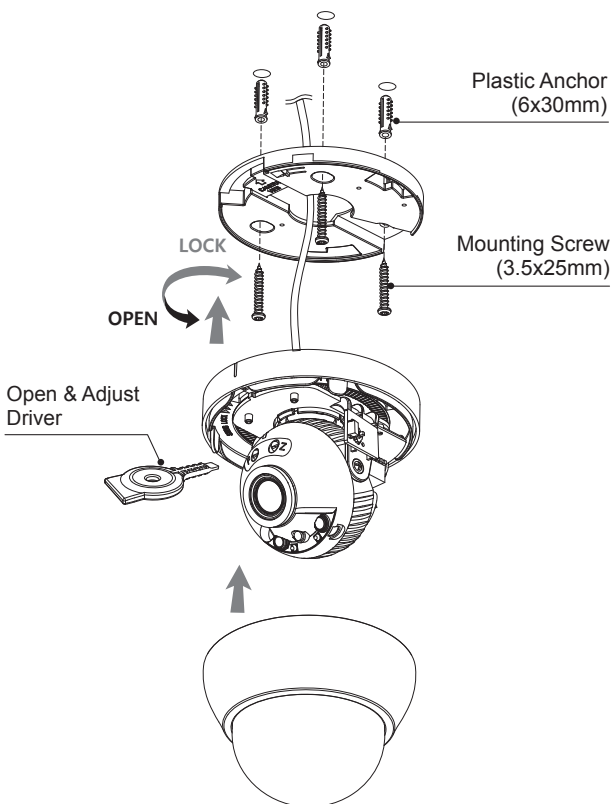

# Installation Instructions

## Limit of pan & tilt

### 1) Pan limit:

Pan is limited to +/- 165°.

Do NOT force to rotate the gimbal over the limit to prevent from the internal damage.

### 2) Tilt limit:

Tilt is limited to 25° min ~ 90° max. with reference to the ceiling when the inclination of camera module is 0°, that is, the image is aligned horizontally.

### 3) Inclination limit

(Horizontal image alignment):

Inclination limited to +/-60° max.

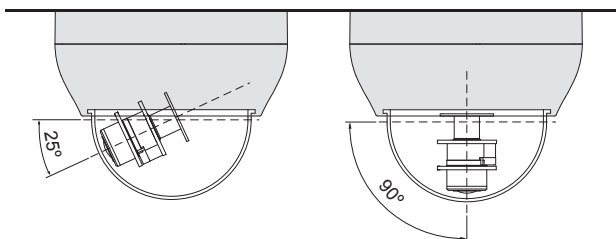
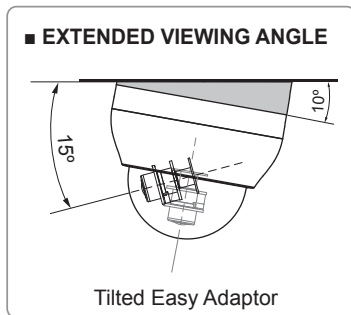

## Zoom & focus adjustments

Use the open & adjust driver supplied.

- Turn the Focus gear until the sharpest focus is made.
- Adjust the zoom for the proper viewing angle.

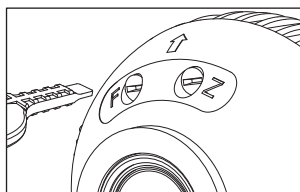

### **!** CAUTION

- Be careful the IR LEDs when you control the OSD setting with the joystick.
- Remove the sticker on the gimbal after the OSD setting



# Installation Instructions

## ■ Detach the dome camera from the easy adaptor

Push the hook on the dome base and swing the dome base to counter-clock wise. Then detach the dome camera from the installed easy adaptor.

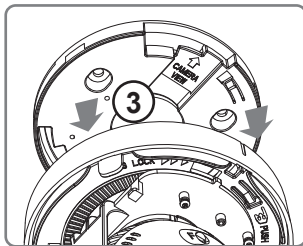
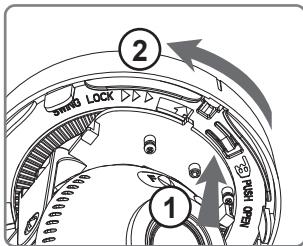

## ■ Open the dome cover

- ① Insert wide side of Open Tool into the lock of Dome Cover.
- ② Hold the Dome housing with one hand and turn the open tool until Dome Cover is sufficiently open.
- ③ Once Dome Base and Dome Cover are detached, press the edge of Dome Cover and pull it down with hands.

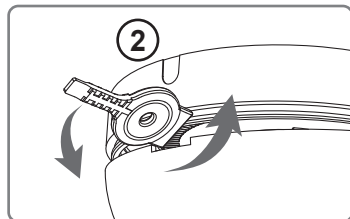
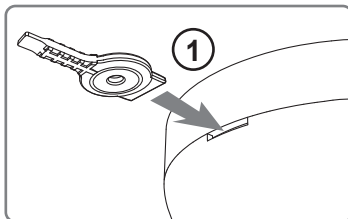

## Power Supply Connections

Camera can be operated with the regulated or unregulated DC12V but the regulated power supply of DC12V is recommended.

Camera is protected from the damage by the reverse connection of polarity.

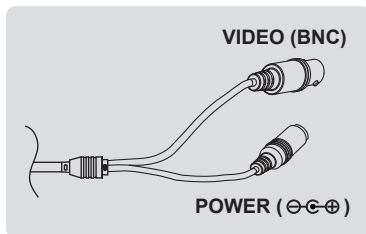

# Operating Instructions

## Using OSD Control Controller

Setup menu can be accessed and controlled by OSD control joy stick on the gimbal of the camera unit. Five commands are available with the joy stick. The design of OSD could be different according to the Model.

### ■ Description of the OSD control operation

- 1] SET Key (●) : Access to the menu or enter the setting.  
To enter the main menu, press the Set Key down.
- 2] UP/DOWN Key (▲/▼) : Choose the desired sub-menu and to move the cursor up or down.
- 3] LEFT/RIGHT Key (◀/▶) : Set up the value of the selected menu. Used to adjust the desired menu selection and to move the cursor left or right.

### ◆ NOTE

If OSD menu is adjusted in specific video format, adjusted value is applied to only related video format. For example, if the menu is adjusted in CVBS mode, adjusted value is applied to CVBS video only.

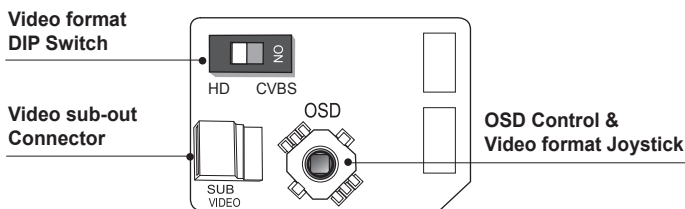

## Using Video Format Switch

### ■ DIP SWITCH setting

The DIP SWITCH setting has first priority.

If the switch is set to CVBS, only CVBS output is available for both main video output and sub-out. Please be advised that camera generates only one video output for both main video output and sub-out. It takes 3~5 seconds when video format is changing. The default DIP SWITCH setting is CVBS mode.

# Operating Instructions

## ■ JOYSTICK setting

Switching video format is available by Video format joystick.

If you want to set the HD video format, set the DIP Switch to HD mode first. Then set the one of HD Video format by joystick. The default setting is TVI mode.

- 1] **TVI mode** (Up▲) : Moving up direction for about 3 seconds to TVI mode.
- 2] **CVBS** (Down▼) : Moving down direction for about 3 seconds to CVBS.
- 3] **AHD** (Left◀) : Moving left direction for about 3 seconds to AHD.
- 4] **CVI mode** (Right▶) : Moving right direction for about 3 seconds to CVI mode.

## OSD menu Startup

Press the 'OSD menu SET key' down to access the setup menu mode.

- EXIT : Enters 'EXIT' menu.
- RETURN : Returns to the previous menu.
- DEFAULT : Restores to factory default.

<b>MAIN MENU</b>	
▶ 1. LENS	DC ↓
2. FOCUS ASSIST	↓
3. EXPOSURE	↓
4. BACKLIGHT	OFF
5. WHITE BAL	ATW
6. DAY & NIGHT	AUTO ↓
7. NR	↓
8. SPECIAL	↓
9. ADJUST	↓
10. EXIT	SAVE&END ↓

# Operating Instructions

## OSD menu Table

MAIN MENU	SUB MENU	CONFIGURATION		
LENS	DC	MODE	INDOOR, OUTDOOR	
		IRIS SPEED		
	MANUAL			
FOCUS ASSIST	DN DWELL			
EXPOSURE	SHUTTER	FLK, 1/60(1/50), 1/30(1/25), AUTO, x30~x2, 1/50000~1/200		
	AGC	0~15		
	SENS UP	OFF, AUTO (2x~30x)		
	BRIGHTNESS	1~100		
	D-WDR	ON(LEVEL:0~8), AUTO, OFF		
	DEFOG	OFF, AUTO	POS/SIZE, GRADATION(0~2), DEFAULT	
BACKLIGHT	OFF			
	HSBLC	SELECT	AREA1~4	
		DISPLAY	ON, OFF	
		BLACK MASK	ON, OFF	
		LEVEL	0~100	
		MODE	ALL DAY, NIGHT(AGC LEVEL)	
		DEFAULT		
BACKLIGHT	BLC	LEVEL, AREA, DEFAULT		
WHITE BAL	ATW, AWB, MANUAL(BLUE/RED GAIN), OUTDOOR, INDOOR, AWC->SET			
DAY & NIGHT	AUTO	D->N(AGC/CDS), D->N(DELAY), N->D(AGC/CDS), N->D(DELAY)		
	EXT	D->N(DELAY), N->D(DELAY)		
	B/W	BURST, IR SMART, IR PWN*		
	COLOR			
NR	2DNR	LOW, MIDDLE, HIGH		
	3DNR(AHD only)	LOW, MIDDLE, HIGH		
SPECIAL	CAM TITLE	OFF, ON		
	D-EFFECT	FREEZE	OFF, ON	
		MIRROR	MIRROR, V-FLIP, ROTATE, OFF	
		NEG. IMAGE		
	MOTION	SELECT	AREA1~4	
		DISPLAY	OFF, ON(POSITION, SIZE)	
		SENSITIVITY	0~100	
		COLOR	Green, Red, White, Blue	
		TRANS	0.00~1.00	
ALARM*		VIEW TYPE, OSD VIEW, ALARM OUT, TIME		

# Operating Instructions

SPECIAL	MOTION	DEFAULT		
	PRIVACY	OFF, ON	SELECT	AREA1~4
			DISPLAY	COLOR, INV, MOSAIC
			COLOR	White, User, Cyan, Green, Yellow, Blue, Red, Black
			TRANS	0.25~1.00
			DEFAULT	
	LANGUAGE	ENG, TUR, NED, POR, RUS, POL, SPA, ITA, FRA, GER, CHN1/CHN2		
	DEFECT	LIVE DPC	AGC LEVEL(0~255), LEVEL(0~100)	
		WHITE DPC	SENS-UP, POS/SIZE, START, DPC VIEW, AGC	
		BLACK DPC	POS/SIZE, START, DPC VIEW, LEVEL	
RS-485*	CAM ID, ID DISPLAY, BAUDRATE			
VERSION	FW VER, ISP VER, AHD RX VER			
COLOR BAR	OFF, ON			
ADJUST	SHARPNESS	AUTO	LEVEL, START AGC, END AGC	
		OFF		
	MONITOR	LDC, CRT		
	LSC	OFF, ON		
	VIDEO OUT	NTSC/PAL		
	COMET (CVBS)	OFF, ON		
MONITOR OUT(HD)	AHD, TVI mode, CVI mode, CVBS			
EXIT	SAVE&END, NOT SAVE, RESET			

(\*) : **Not Available**



# Operating Instructions

## OSD menu Setup

### 1. LENS (default: DC)

Lens can be selected either DC or MANUAL lens.

Lens MUST be set to DC for the best image when DC iris lens is installed

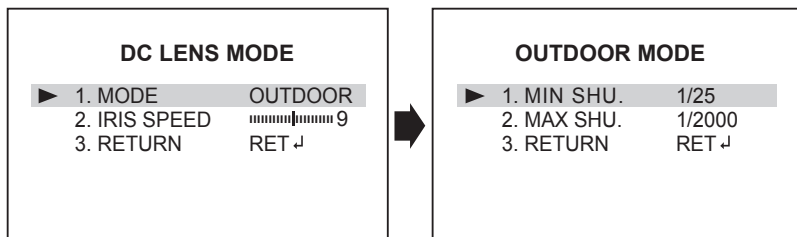

#### 1-1. DC LENS MODE

: Selects lens mode according to installation place.

##### 1-1-1. MODE

- INDOOR: Optimized of indoor environment.
- OUTDOOR: Optimized of outdoor environment. Can set Min.SHUTTER speed or Max.SHUTTER speed

##### 1-1-2. IRIS SPEED

: Sets IRIS speed for INDOOR or OUTDOOR mode.

#### 1-2. MANUAL LENS MODE

: Horizontal wave or bar may be seen when MANUAL is selected and the camera is working under florescent or similar lights.

## 2. FOCUS ASSIST

Usually cameras are installed in the day time and they often become OUT OF FOCUS at night time and IN FOCUS again at next day time.

This problem can occur at any cameras regardless of types or manufacturers. FOCUS ASSIST menu is the unique and patented feature that prevents from the wrong focus and helps the EXACT NEEDLE focus by simulating DAY & NIGHT conditions.

Set zoom first and adjust focus to get NEEDLE FOCUS while switching at DAY & NIGHT.

# Operating Instructions

## FOCUS ASSIST

- ▶ 1. DN DWELL 5 SEC
- 2. RETURN RET↓

ADJUST ZOOM & FOCUS ON LENS  
FOR DAY & NIGHT WHILE SWITCHINGS

### 2-1. DN DWELL

: ICR switcher switches DAY & NIGHT at the interval of D/N DWELL to help the EXACT NIDDLE focus at DAY and NIGHT mode.

Further simulations are performed internally during switching.

## 3. EXPOSURE

[ video format: HD ]

EXPOSURE	
▶ 1. SHUTTER	FLK
2. AGC	■■■■■■■■■■ 14
3. SENS-UP	AUTO↓
4. BRIGHTNESS	■■■■■■■■■■ 38
5. D-WDR	AUTO
6. DEFOG	OFF
7. RETURN	RET↓

[ video format: CVBS ]

EXPOSURE	
1. SHUTTER	---
2. AGC	■■■■■■■■■■ 14
▶ 3. SENS-UP	AUTO↓
4. BRIGHTNESS	■■■■■■■■■■ 45
5. D-WDR	AUTO
6. DEFOG	OFF
7. RETURN	RET↓

### 3-1. SHUTTER (default: FLK)

: Selects AUTO, FLK(Flickerless), or set manually.

If SHUTTER set to MANUAL or FLK modes, SENS-UP mode is inactivated.

If DC LENS MODE in the LENS option is set to OUTDOOR, SHUTTER mode is inactivated.

- FLK : Reduces the flicker in video when NTSC/PAL mode is used in 50Hz / 60Hz fluorescent lighting respectively.
- 1/60(1/50), 1/30(1/25), x30~x2, 1/50000 ~ 1/240: Shutter can be set to fix.
- AUTO: Optimizes the video level by controlling the iris and the shutter speed automatically.

# Operating Instructions

## 3-2. AGC

: AGC(0~15) amplifies the video gain for brighter video but noise and white pixel accordingly. AGC level less than 10 disables AUTO in DAY/NIGHT.

## 3-3. SENS-UP

: The brighter video can be obtained by increasing the exposure time in the night with SENS-UP. SENS-UP is the maximum integrations of frame by DSS (Digital Slow Shutter) in the low light.

- AUTO: SENS-UP is enabled or disabled automatically by the scene brightness. Higher SENS-UP can get the brighter video but the slower frame rates with more white pixels. If set to AUTO, maximum integration limit for SENS-UP can be set to x2, x4, x6, x8, x10, x15, x20, x25, x30 in SENS-UP menu.
- OFF: Disables SENS-UP.

## 3-4. BRIGHTNESS

: Adjusts the brightness of video(1~100).

## 3-5. D-WDR

: Improves the visibility for the high bright area and the dark area by compensating the video gain. Selects OFF, AUTO or ON. With D-WDR On, the level can be set. Care should be taken to select this mode because video may lose its quality in some environments by the over compensation. Video noise can be increased in the dark area accordingly.

※ CVBS video signal: Connecting 2nd video to CVBS port disables D-WDR function temporary. It should be considered when installer adjusts the video with installation monitor via CVBS video signal.

## 3-6. DEFOG (default: OFF)

: Enhance the foggy video according to status of scene. Video quality can be less in normal environments. Setting to AUTO, it can be adjusted working area on screen.

### 3-6-1. POS/SIZE

: Sets the position and size to make activated area box.

### 3-6-2. GRADATION

: Sets the level from 0 to 10.

### 3-6-3. DEFAULT

: Restores to factory default.

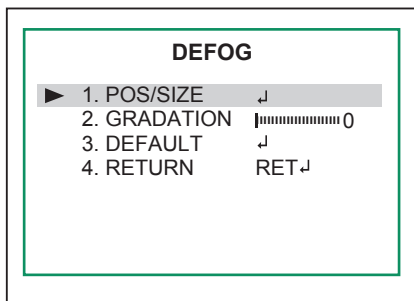

# Operating Instructions

## 4. BACKLIGHT

: Cuts out the highlight area with black mask and excludes it from compensation. It has target areas for compensation and each area can be set LEVEL, MODE, and DISPLAY.

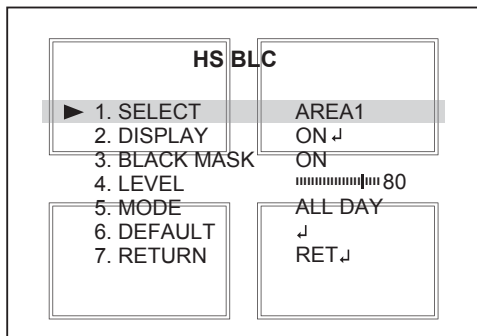

### 4-1. HS BLC

: Cuts out the highlight area with black mask and excludes it from compensation.

4-1-1. SELECT : Select areas to set HS BLC function

4-1-2. DISPLAY : Displays ON/OFF the selected area and adjusts position/size.

4-1-3. BLACK MASK : Sets ON or OFF the black mask.

4-1-4. LEVEL (0~100): Sets the HS BLC level. It determines the video level that starts cutting out. Lower setting starts the cut out at lower level. The cut out area is masked with black color.

4-1-5. MODE : Sets NIGHT only or ALL DAY.

- ALL DAY : Enables HS BLC regardless of DAY or NIGHT mode.
- NIGHT : Enables HLC only when camera works in NIGHT mode. Can be adjusted AGC level.

4-1-6. DEFAULT : Restores to factory default.

### 4-2. BLC

: This function is used to brighten an image in the foreground with a highly light area behind it such as sunlight, limiting the affect of silhouette.

4-2-1. LEVEL (default: MIDDLE) : Sets the BLC level.

4-2-2. AREA : Sets BLC area with position and size.

4-2-3. DEFAULT : Restores to BLC factory default.



# Operating Instructions

---

## 6-1. AUTO (AGC/CDS)

Used when DAY or NIGHT is determined by light level through the lens and DAY from/to NIGHT is switched automatically by the scene brightness. It can be controlled the threshold level and delay time.

### 6-1-1. D→N (AGC/CDS):

D→N is a threshold level which determines to switch from DAY to NIGHT. Lower(Higher) value makes the camera switch from Day to Night at lower(higher) illumination. If it stays in Day(Color) mode at night time, increase DAY→NIGHT threshold value until it just switches to Night.

### 6-1-2. D→N (DELAY):

D→N DELAY is time in second while camera maintains its status before Day to Night switches. DELAY can avoid the unwanted/frivolous switching by a short term lights such as light from the passing car.

### 6-1-3. N→D (AGC/CDS):

N→D is a threshold level which determines to switch from NIGHT to DAY. Lower(Higher) value makes the camera switch from Night to Day at lower(higher) illumination. If it stays in NIGHT(B/W) mode at day time, decrease NIGHT→DAY threshold value until it just switches to DAY.

### 6-1-4. N→D (DELAY):

N→D DELAY is time in second while camera maintains its status before Night to Day switches.

## 6-2. EXT

EXT is not related to this model. AUTO(CDS) works like EXT.

## 6-3. B/W

The camera is always in B/W mode.

Forcibly removes IR cut filter and switches to B/W regardless of light level.

### 6-3-1. BURST :

Sets the BURST option ON/OFF to output burst signal in B/W mode.

### 6-3-2. IR SMART :

SMART IR can be set to reduce the saturation by the strong IR illumination in the night in any menu. Zero(0) turns off SMART IR and High setting avoids the saturation strongly but the corners will be darker accordingly.

- LEVEL (0~15): Sets the IR brightness level
- AREA: Sets the IR SMART working area with position and size.

### 6-3-3. IR PWM\* : Not Available

# Operating Instructions

## 6-4. COLOR

The camera is always in COLOR mode.

Forcibly DAY/NIGHT is disabled and outputs color video.

## 7. NR (Noise Reduction)

NR function improves picture quality by filtering out signal noise which is generated under the low light conditions. Sets 2DNR or 3DNR level. 3DNR(3-dimensional noise reduction) which reduces the noise by the multi frames (HD format only). Noise Reduction is effective at low light. Setting high level is strength of noise reduction but the result may occur in loss of sharpness and the tail effect of a comet.

[ video format: **HD** ]

NR	
▶ 1. 2DNR	LOW
2. 3DNR	MIDDLE
3. RETURN	RET↵

[ video format: **CVBS** ]

NR	
▶ 1. 2DNR	MIDDLE
2. RETURN	RET↵

## 8. SPECIAL

SPECIAL	
▶ 1. CAM TITLE	ON ↵
2. D-EFFECT	↵
3. MOTION	OFF
4. PRIVACY	OFF
5. LANGUAGE	ENG ↵
6. DEFECT	↵
7. RS485	↵
8. VERSION	↵
9. COLOR BAR	OFF
9. RETURN	RET↵

# Operating Instructions

## 8-1. CAM TITLE

: Camera title(name) can be set and edited up to 15 alpha numeric and symbolic characters. ▲, ▼, ◀, ▶ moves the cursor and choose a character to select it. The selected characters are added and displayed on the input line.

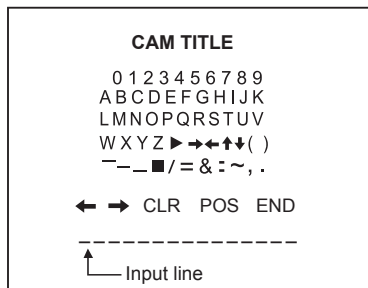

- ← → : To move the cursor on input line
- CLR : To clear CAMERA TITLE on input line when pressed '●'.
- POS : To set the location of CAM TITLE to be displayed on the monitor, move a cursor to POS and press '●' set button. Moves CAMERA TITLE where desired position by using four direction buttons then press a set button '●' to fix.
- END : Finish the CAMERA TITLE on input line and return to previous menu mode.

## 8-2. D-EFFECT

: It is related picture adjustments.

8-2-1. FREEZE : The still cut picture from video is displayed while setting to ON.

8-2-2. MIRROR : The picture will be flipped horizontally or vertically if it turns ON. When the video is flipped by Ver. or HV, then the joystick directions are reversed accordingly. It is very useful when a camera is installed in upside down.

- OFF : Normal display without mirroring or flipping
- MIRROR. : Video is reversed left and right
- V-FLIP : Video is reversed upside down
- ROTATE : Video is reversed width and length

8-2-3. NEG.IMAGE : The picture will be changed to negative image if it turns ON.

## 8-3. MOTION

Up to 4 motion detection areas are available and each area is programmable in size and location. The motion can be detected the changes in the motion areas and displays the results in blocks and/or a text message.





# Operating Instructions

- VIEW TYPE: Selects display type for motion detection.
  - > ALL - Enables to display types both of OUTLINE and BLOCK, if motion is detected.
  - > OUTLINE - Enables to display box shape, if motion is detected.
  - > BLOCK - Enables to display mosaic shape, if motion is detected.
  - > OFF - Disables to display
- OSD VIEW : ON enables to display a text message or icon.
- ALARM OUT : Not Available.
- TIME (1~15) : Sets the interval time from the starting of motion operation until being ready for the next motion operation.

8-3-7. DEFAULT : Restores to factory default.

## 8-4. PRIVACY

Sets ON/OFF for enabling/disabling PRIVACY.

Up to 4 privacy areas are available and each area is programmable in size, color and position.

<b>PRIVACY</b>	
▶ 1. SELECT	AREA1
2. DISPLAY	COLOR ↓
3. COLOR	WHITE
4. TRANS.	1.00
5. DEFAULT	↓
6. RETURN	RET ↓

8-4-1. SELECT : Selects one pre-setting from AREA1 to AREA4.

8-4-2. DISPLAY : Enables or disables the privacy mask which you selected AREA by COLOR, INV. or MOSAIC.

8-4-3. COLOR : Choose one of 8 colors to be masked.  
WHITE, USER, CYAN, GREEN, YELLOW, BLUE, RED, BLACK

8-4-4. TRANS.: Selects transparency rate for the mask area from 0.25 to 1.00

0.25 - Privacy mask is 25% transparent.

0.50 - Privacy mask is 50% transparent.

1.00 - Privacy mask is not transparent.

8-4-5. DEFAULT : Restore the current setting to factory default.

# Operating Instructions

## 8-5. LANGUAGE

12 languages are available for OSD menu. ENG, TUR, NED, POR, RUS, POL, SPA, ITA, FRA, GER, CHN2, CHN1.

Choose one preferred language and enter the 'SET' key.

## 8-6. DEFECT

: Detects and compensates the defective pixels.

Once CALIBRATE is selected, the pixel calibration is initiated with lens closed and can't cancel.

### 8-6-1. LIVE DPC :

Sets AGC level and DPC level for live DPC function.

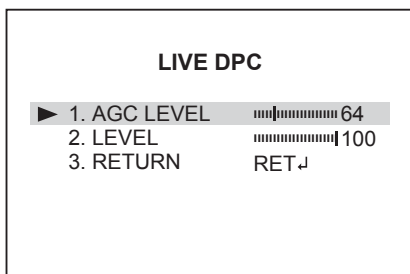

### 8-6-2. WHITE DPC : Setting for white defective pixels.

- POS/SIZE: Adjusts DPC AREA window size and position.
- START : Starts up detecting and compensation.
- DPC VIEW: Shows the original defective pixels if set to ON
- LEVEL: Sets the threshold of the detection for white pixels. High value increases the video gain in order to show the defective pixels easily. Too high value can result in compensation failure.
- AGC : Sets AGC level. AGC amplifies the video gain for brighter video but noise and white pixels accordingly.
- SENS-UP:  
Sets sens-up level by the scene brightness.  
Setting high level can get the brighter video but white pixels accordingly.

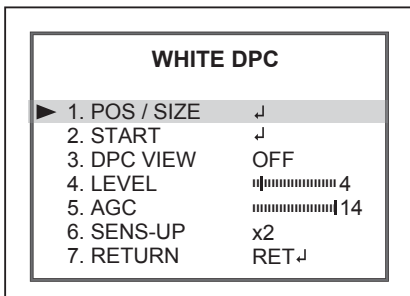



# Operating Instructions

9-1-1. LEVEL : Increases or decreases the sharpness of the picture.

Too much sharpness can make image harsh and show more noise as well as line flicker at the edge of object.

9-1-2. START AGC : Defines the AGC level to start up for sharpness

9-1-3. END AGC : Defines the AGC level to end up for sharpness

## 9-2. MONITOR

: Selects LCD or CRT modes the correct type of viewing monitor will ensure the most optimal picture. Each monitor type can be adjusted picture quality by BLUE/RED GAIN.

[ video format: HD ]

LCD	
▶ 1. GAMMA	USER
2. BLUE GAIN	68
3. RED GAIN	65
4. RETURN	RET ↵

[ video format: CVBS ]

LCD	
▶ 1. BLACK LEVEL	0
2. GAMMA	USER
3. BLUE GAIN	58
4. RED GAIN	58
5. RETURN	RET ↵

[ video format: HD ]

CRT	
▶ 1. BLUE GAIN	58
2. RED GAIN	58
3. RETURN	RET ↵

[ video format: CVBS ]

CRT	
▶ 1. BLACK LEVEL	0
2. BLUE GAIN	52
2. RED GAIN	52
3. RETURN	RET ↵

- GAMMA :  
Select the brightness level of monitor from USER, 1.00, 0.95 ~0.45.
- BLUE/RED GAIN :  
Set the saturation level of monitor with BLUE or RED GAIN.
- BLACK LEVEL (960H format only):  
Compensates dark area of monitor image. It can be adjusted level from 0 to 60.

# Operating Instructions

---

## 9-3. LSC (Lens Shade Compensation)

: Enhances the brightness at the corners caused by the lens or the narrow emitting angle of IR LEDs. Picture could be noisy if it is ON. When relatively picture looks noisy, please set it to OFF.

## 9-4. VIDEO OUT

: Selects HDTV standards for analog video output switches to NTSC or PAL accordingly. If the TV standard is changed, it is applied to all video format. (TVI mode, CVI mode, AHD, CVBS)

## 9-5. MONITOR OUT (TVI mode/CVI mode/ AHD/ CVBS)

: 1080P Full-HD. It takes 3~5 seconds when video format is switching. Please check that video format of the DIP Switch on OSD board.

### ■ NOTE

The DIP Switch setting has first priority. If the switch is set to CVBS, the video format is not available change to HD video format(TVI mode, CVI mode, AHD). At that time, please set the switch to CVBS.

9-5. COMET (CVBS only) : Not Available

10. EXIT : Exits SETUP MENU and returns to the normal display.

10-1. SAVE & END : Save all the setting and exit the setup menu.

10-2. NOT SAVE : Exit the setup menu without save.

10-3. RESET : Loading Factory Default.

# Specifications

ITEM	NTSC	PAL
<b>Imaging Sensor</b>	1/2.8" Sony 2M pixel Bayer CMOS sensor	
<b>Effective Pixels</b>	1920(H) x 1080(V) x 30p	1920(H) x 1080(V) x 25p
<b>Scan Frequency</b>	HDJ 30Hz(V), 22.5KHz(H) / Progressive	HDJ 25Hz(V), 18.75KHz(H) / Progressive
	CVBS] 59.94Hz(V), 15.734KHz(H) 2:1 Interlace	CVBS] 50Hz(V), 15.625KHz(H) 2:1 Interlace
<b>Electronic Iris</b>	1/30~1/50,000sec	1/25~1/50,000sec
<b>Video Format</b>	HDJ 16:9, 1080p@30fps	HDJ 16:9, 1080p@25fps
	CVBS] 4:3, 750TVL	CVBS] 4:3, 750TVL
<b>Synchronization</b>	Internal	
<b>H. Resolution</b>	HDJ 1080p@30/25 fps	
	CVBS] 750TVL	
<b>Sensitivity</b>	Color: 0.3 Lux (@IRE 40, Sens-up On, IR Off) BW: 0.005 Lux (@IRE 40, Sens-up On, IR Off)	
<b>S/N Ratio</b>	More than 52dB with AGC Off at 50 IRE	
<b>Lens</b>	f= 2.7~13.5 mm F1.3 Mega pixel DC Auto Iris vari-focal lens	
<b>LED</b>	2pcs x 850nm High power SMD LED	
<b>DAY / NIGHT</b>	True Day&Night by ICR	
<b>White Balance</b>	ATW / AWB / AWC -> SET / INDOOR / OUTDOOR / MANUAL	
<b>Sens-up</b>	Yes (2x ~30x)	
<b>WDR</b>	D-WDR	
<b>DNR</b>	HDJ 2D+3DNR	
	CVBS] 2DNR	
<b>Mirror/Flip</b>	Off, H, V, H/V	
<b>Function</b>	Focus Assist, BLC/HSBLC, Motion detection, Privacy mask, Freeze, Defog, Negative Image, IR Smart, Cam Title, LSC (Lens Shading Compensation), DPC(Defective Pixel Compensation)	
<b>Language</b>	ENG, TUR, NED, POR, RUS, POL, SPA, ITA, FRA, GER, CHN2/CHN1	
<b>Video Output</b>	TVI mode/CVI mode/AHD, 1080P(@30/25 fps)	
	960H CVBS (NTSC/PAL)	

# Specifications

<b>Operating Temp.</b>	-10°C ~ +50°C (Humidity: 20%RH ~ 80%RH.)
<b>Power Consumption</b>	DC12V=470mA, 6W Circuit protection against faulty connection in power polarity.
<b>Housing</b>	Double side Anti-scratch Hard coated clear bubble, Zoom & Focus adjustment on 3-Axis gimbal, Easy Installation Adaptor (Flat/Tilted adaptor)
<b>Dimension</b>	Ø116mm(W) x 94mm(H)_ Bubble: Ø80 / About: 260g

(\*) Design and specifications are subject to change for product improvements without prior notice.











eneo® is a registered trademark of  
Videor E. Hartig GmbH  
Exclusive distribution through specialised  
trade channels only.

Videor E. Hartig GmbH  
Carl-Zeiss-Straße 8  
63322 Rödermark/Germany  
Tel. +49 (0) 6074 / 888-0  
Fax +49 (0) 6074 / 888-100  
[www.videor.com](http://www.videor.com)  
[www.eneo-security.com](http://www.eneo-security.com)

Technical changes reserved

© Copyright by Videor E. Hartig  
GmbH Version 09/2021