

# User Manual

**Hybrid HD Video Recorder,  
HD-TVI, AHD, HDMI,  
SATA, w/o HDD**

**MNR-18N04000A**

**MNR-18N16000A**

**Learn more about eneo IN series  
on our YouTube channel.**



## CONTENT

<b>SAFETY INSTRUCTION</b> .....	<b>6</b>
<b>CHAPTER 1: PRODUCT OVERVIEW</b> .....	<b>7</b>
1.1 REAR PANEL.....	7
1.2 REMOTE CONTROL (FOR REFERENCE ONLY, SUBJECT TO MATERIAL OBJECTS).....	8
<b>CHAPTER 2 DVR INSTALLATION &amp; CONNECTION</b> .....	<b>8</b>
2.1 HDD INSTALLATION .....	8
2.2 CONNECTION DIAGRAM .....	9
2.3 POWER SUPPLY CONNECTION .....	10
<b>CHAPTER 3 DVR COMMON OPERATIONS</b> .....	<b>10</b>
3.1 USING THE SUPPLIED MOUSE .....	10
3.2 USING THE VIRTUAL KEYBOARD .....	10
3.3 PASSWORD .....	11
<b>CHAPTER 4 DVR STARTING UP</b> .....	<b>13</b>
4.1 START WIZARD .....	13
4.1.1 <i>Start Wizard</i> .....	13
4.1.2 <i>Network configuration</i> .....	13
4.1.3 <i>Date/Time</i> .....	14
4.1.4 <i>IP Camera</i> .....	15
4.1.5 <i>Disk</i> .....	16
4.1.6 <i>Resolution</i> .....	16
4.1.7 <i>Mobile</i> .....	16
4.1.8 <i>Summary</i> .....	16
4.2 INTRODUCTION OF THE REAL-TIME VIEW INTERFACE.....	17
4.2.1 <i>Camcorder Quick Toolbar</i> .....	18
4.2.2 <i>Taskbar</i> .....	18
4.2.3 <i>The Start Menu</i> .....	19
4.2.3.1 <i>Unlock and Lock the screen</i> .....	19
4.2.3.2 <i>Equipment shutdown</i> .....	19
<b>CHAPTER 5: DVR SYSTEM SETTINGS</b> .....	<b>20</b>
5.1 CHANNEL .....	20
5.1.1 <i>Channel</i> .....	21
5.1.1.1 <i>Channel setup</i> .....	21
5.1.1.2 <i>IP Channels</i> .....	21
5.1.2 <i>Live</i> .....	23
5.1.3 <i>Image control</i> .....	24
5.1.4 <i>PTZ</i> .....	25
5.1.4.1 <i>PTZ control</i> .....	26
5.1.5 <i>The Privacy Area</i> .....	29
5.1.6 <i>Motion</i> .....	30
5.1.7 <i>PIR</i> .....	31
5.1.8 <i>White Light</i> .....	31
5.1.9 <i>Intelligent (Intelligent Analytics)</i> .....	33

5.1.9.1 PID (Perimeter intrusion detection).....	33
5.1.9.2 LCD (Line Crossing Detection).....	35
5.1.9.3 SOD (Stationary Object Detection) .....	36
5.1.9.4 PD&VD (pedestrian and vehicle type detection) .....	38
5.1.9.5 FD (face detection) .....	39
5.1.9.6 CC (Cross-Counting) .....	40
5.1.9.7 Sound Detection.....	42
5.1.9.8 Video Tampering (Video Tampering) .....	43
5.1.9.9 Schedule (Smart Schedule) .....	43
5.1.9.10 Cross Counting Statistics (crossing statistics) .....	44
5.2 RECORDING .....	45
5.2.1 <i>Encoding</i> .....	45
5.2.1.1 Mainstream.....	45
5.2.1.2 Substream.....	46
5.2.1.3 Mobilestream.....	47
5.2.1.4 Audio .....	48
5.2.2 <i>Video recording</i> .....	48
5.2.2.1 Video recording Settings .....	48
5.2.2.2 Video recording schedule.....	49
5.2.3 <i>Capture</i> .....	49
5.2.3.1 Capture settings 1.....	49
5.2.3.2 Capture Schedule table 2 .....	50
5.3 ALARM .....	51
5.3.1 <i>Mobile detection and alarm</i> .....	51
5.3.2 <i>PIR alarm</i> .....	52
5.3.3 <i>I/O Alarm</i> .....	53
5.3.4 <i>Intelligent analysis and alarm</i> .....	55
5.3.4.1 PID (Perimeter intrusion Detection) .....	55
5.3.4.2 LCD (Line Cross detection and alarm) .....	56
5.3.4.3 SOD ((Stationary Object Detection)) .....	57
5.3.4.4 PD&VD (Pedestrian Detection & Vehicle Detection).....	58
5.3.4.5 FD (face detection) .....	59
5.3.4.6 CC (Cross-Counting) .....	60
5.3.4.7 Sound Detection.....	61
5.3.4.8 Video Tampering .....	62
5.3.5 <i>Combined alarm</i> .....	63
5.3.6 <i>PTZ linkage</i> .....	65
5.3.7 <i>Exception</i> .....	65
5.3.8 <i>Alarm Schedule</i> .....	66
5.3.9 <i>Voice broadcast</i> .....	66
5.3.9.1 Document management .....	66
5.3.9.2 loop management .....	68
5.4 AI .....	68
5.4.1 <i>Setup</i> .....	68
5.4.1.1 Face detection.....	68
5.4.1.2 Pedestrian and vehicle detection .....	69
5.4.1.3 Perimeter invasion detection .....	70
5.4.1.4 Line Crossing detection.....	72

5.4.1.5 Cross Counting statistics .....	73
5.4.1.6 Heat map .....	75
5.4.1.7 Crowd Detection.....	76
5.4.1.8 Queueing length detection.....	77
5.4.1.9 License plate detection .....	78
5.4.1.10 RSD .....	79
5.4.1.11 Schedule .....	79
<b>5.4.2 Recognition .....</b>	<b>80</b>
5.4.2.1 Model configuration .....	80
5.4.2.2 Face Database Management .....	80
5.4.2.3 License plate database management.....	82
<b>5.4.3 Alarm settings.....</b>	<b>85</b>
5.4.3.1 Face recognition alarm.....	85
5.4.3.2 Face attribute alarm .....	87
5.4.3.3 License plate recognition .....	87
5.4.3.4 Pedestrian and vehicle detection .....	89
5.4.3.5 Pedestrian intrusion.....	90
5.4.3.6 Line Cross Detection .....	92
5.4.3.7 CC.....	93
5.4.3.8 CD.....	94
5.4.3.9 QD Alarm .....	95
5.4.3.10 LPD .....	96
5.4.3.11 RSD .....	97
<b>5.4.4 Statistics .....</b>	<b>98</b>
5.4.4.1 Face recognition statistics .....	98
5.4.4.2 Pedestrian and vehicle detection statistics.....	98
5.4.4.3 CC.....	99
5.4.4.4 Heat map .....	100
<b>5.5 NETWORK.....</b>	<b>101</b>
<b>5.5.1 General.....</b>	<b>101</b>
5.5.1.1 General configuration .....	101
5.5.1.2 PPPo E.....	101
5.5.1.3 SNMP.....	102
5.5.1.4 Wireless configuration .....	102
5.5.1.5 Port Configuration .....	103
<b>5.5.2 DDNS (Dynamic Domain name server) .....</b>	<b>104</b>
<b>5.5.3 Email.....</b>	<b>104</b>
5.5.3.1 Email Configuration .....	105
5.5.3.2 Email Schedule .....	105
<b>5.5.4 FTP.....</b>	<b>106</b>
<b>5.5.5 IP Filter.....</b>	<b>107</b>
<b>5.5.6 Voice Assistant.....</b>	<b>107</b>
5.5.6.1 Amazon.....	107
5.5.6.2 Google .....	112
<b>5.5.7 Platform Access.....</b>	<b>118</b>
5.5.7.1 Onvif.....	118
<b>5.6 DEVICE .....</b>	<b>118</b>



5.6.1 Disk.....	118
5.6.1.1 Disk Group .....	119
5.6.1.2 S.M.A.R.T.....	120
5.6.2 Cloud.....	120
5.7 SYSTEM .....	121
5.7.1 <i>General</i> .....	121
5.7.1.1 General Configuration.....	121
5.7.1.2 Date and Time .....	122
5.7.1.3 Output Configuration.....	123
5.7.2 <i>Multi-user</i> .....	125
5.7.2.1 Changing Password and Add New Users .....	126
5.7.2.2 Add New Users .....	126
5.7.2.3 Setting User Permissions.....	127
5.7.3 <i>Maintenance</i> .....	128
5.7.3.1 Log.....	128
5.7.3.2 Load Default .....	129
5.7.3.3 Reset setting.....	130
5.7.3.4 Upgrade .....	130
5.7.3.4.1 USB Upgrade .....	130
5.7.3.4.2 Online upgrade.....	130
5.7.3.5 Parameter Management.....	131
5.7.3.6 Auto Reboot.....	131
5.7.3.7 Developer Mode.....	132
5.7.4 <i>IP Camera Maintain</i> .....	132
5.7.4.1 Upgrade IP Camera.....	132
5.7.4.2 Load Default Settings for IP Camera.....	133
5.7.4.3 Reboot IPC .....	133
5.7.4.4 Manage IPC parameters.....	133
5.7.4.5 Format IPC .....	134
5.7.5 <i>System Information</i> .....	134
5.7.5.1 Information.....	134
5.7.5.2 Channel Information.....	134
5.7.5.3 Record Information.....	135
5.7.5.4 Network State .....	135
<b>CHAPTER 6: AI SCENARIO-BASED APPLICATION.....</b>	<b>136</b>
6.1 FACE ATTENDANCE .....	136
6.2 CC SCENARIO .....	139
6.2.1 <i>channel</i> .....	139
6.2.2 <i>Groups</i> .....	140
6.2.3 <i>Search</i> .....	141
6.2.4 <i>Settings</i> .....	141
6.3 NON-HUMAN MACHINE STATISTICS .....	143
<b>CHAPTER 7 SEARCH, PLAYBACK &amp; BACKUP.....</b>	<b>144</b>
7.1 USING SEARCH FUNCTION .....	144
7.1.1 <i>Search &amp; Play Video in General</i> .....	146
7.1.1.1 Video Clip Backup.....	146

7.1.2 Event Search, Playback & Backup.....	147
7.1.2.1 Event Playback Control .....	149
7.1.3 Sub-periods Playback.....	149
7.1.4 Smart.....	150
7.1.5 TAG.....	151
7.1.6 External File .....	152
7.1.7 Picture Search & View.....	152
7.1.7.1 Picture Preview Control .....	154
7.1.8 SPLIT PLAYBACK.....	155
7.1.9 AI.....	155
7.1.9.1 Face .....	155
7.1.9.1.1 Face track chart.....	156
7.1.9.2 License plate detection .....	157
7.1.9.3 Pedestrian and Vehicle.....	158
7.1.9.4 PID&LCD.....	159
7.1.9.5 Repeat Visitors .....	159
7.1.9.6 Face attendance .....	160
<b>CHAPTER 8 REMOTE ACCESS VIA WEB CLIENT.....</b>	<b>161</b>
8.1 BASIC SYSTEM ENVIRONMENT REQUIREMENTS .....	161
8.2 WEB PLUGIN DOWNLOAD AND INSTALLATION.....	162
8.3 WEB CLIENT MANAGER .....	163
8.3.1 Live Interface.....	163
8.3.2 Playback.....	167
8.3.2.1 Playback Control Buttons.....	168
8.3.2.2 Picture playback .....	169
8.3.2.3 Tag playback.....	170
8.3.2.4 Smart Playback.....	171
8.3.2.5 AI Playback.....	171
8.3.3 Remote Setting.....	172
8.3.4 Local Setting.....	172
<b>CHAPTER 9 VIEWING BACKED UP VIDEO ON PC/MAC.....</b>	<b>173</b>
<b>CHAPTER 10 REMOTE ACCESS VIA MOBILE DEVICES.....</b>	<b>176</b>
<b>CHAPTER 11 APPENDIX .....</b>	<b>178</b>
.11.1 FAQ QUESTIONS .....	178
11.2 USAGE MAINTENANCE .....	179
11.3 ACCESSORIES (FOR REFERENCE ONLY) .....	180

## SAFETY INSTRUCTION

Please carefully read the following safety instruction so as to avoid personal injuries and prevent the equipment and other connection devices from being damaged.

1. Power sources (note: please use the power supply attached or specified by the manufacturer)

Never operate the equipment by using unspecified power supply.

2. Never push objects of any kind through openings of DVR so as to avoid electric shock or other accidents.

3. Do not put the equipment in the dusty field

4. Do not place the equipment under rain or humid environment. If the equipment is accidentally in contact with water, please unplug the power cable and immediately contact your local dealer.

5. Keep the surface of the equipment clean and dry. Use soft damp cloth to clean the outer case of DVR (do not use liquid aerosol cleaners)

6. Do not operate if any problems are found. If there are any strange smell or sound from DVR, unplug the power cable and contact the authorized dealer or service center.

7. Do not try to remove the upper cover

Warning: Do not remove the cap of DVR so as to avoid electric shock.

8. Handle with care

If DVR does not work normally because of hitting on the hard object, please contact the authorized dealer for repair or replacement.

9. Use standard lithium battery (Note: Use the batteries attached or specified by the manufacturer)

After cutting off the power supply, if the system clock cannot continue to work, please replace the standard 3V lithium battery on the main board.

Warning: Turn off DVR before replacing the batteries, or you may be suffered from serious electric shock. Please properly dispose of the used batteries.

10. Put the equipment in a place with good ventilation

The DVR system includes HDD, which produces large amount of heat during operation. As a result, do not block the ventilation openings (on the top, bottom, both sides and the reverse side) for cooling the system during operation. Install or put the equipment in the place with good ventilation.

11. The attached power adapter can only be used for 1 set of DVR. Do not connect more equipment, or DVR may be restarted repeatedly because of insufficient power.

12. Prevent the equipment from water dropping or splashing. Do not place objects containing water, such as flower vase, on the equipment.

13. Do not ingest battery, Chemical Burn Hazard,

This product contains a coin / button cell battery.

If the coin / button cell battery is swallowed, it can cause severe internal burns in just 2 hours and can lead to death.

Keep new and used batteries away from children.

If the battery compartment does not close securely, stop using the product and keep it away from children.

If you think batteries might have been swallowed or placed inside any part of the body, seek immediate medical attention.

**Notice:**

Do not ingest battery, Chemical Burn Hazard,

This product contains a coin / button cell battery.

If the coin / button cell battery is swallowed, it can cause severe internal burns in just 2 hours and can lead to death.

Keep new and used batteries away from children.

If the battery compartment does not close securely, stop using the product and keep it away from children.

If you think batteries might have been swallowed or placed inside any part of the body, seek immediate medical attention

Chapter 1: Product Overview

1.1 Rear Panel

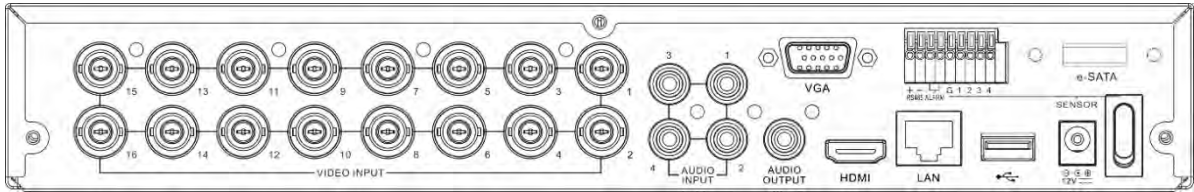

Item	Description
VIDEO INPUT	Connect with video input devices, standard BNC port
AUDIO INPUT	Connect with audio input signals, RCA port
AUDIO OUTPUT	Audio signal output, RCA port
USB port	Connect the supplied mouse or USB flash memory
VGA	Connect to your TV or a monitor with VGA input.
HDMI	Connect to your digital TV or monitor with HDMI input
LAN	Connect to your home network
e-SATA	Optional. Connect to e-SATA HDD for recording & backup
RS-485	Connect to PTZ devices
Sensor & Alarm	Optional. Connect to external sensor & alarm devices
Power	Connect to the supplied power adaptor
Power Switch	Turn on /off power supply

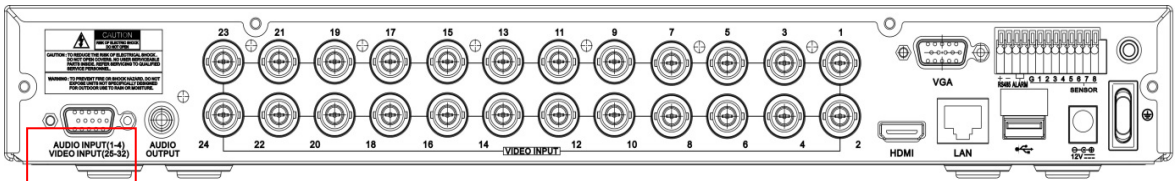

Audio input (1-4) & Video input (25-32)

Some 32 channel DVR models can be connected to the audio input using the include connector (25 CH

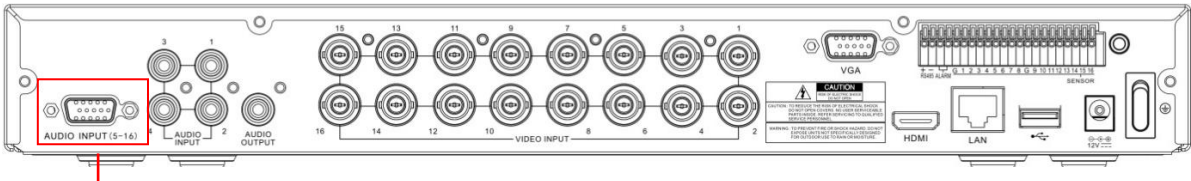

Audio input (5-16)

Some 16-32-channel DVR models can be connected to the audio input using the included connector

1.2 Remote control (for reference only, subject to material objects)

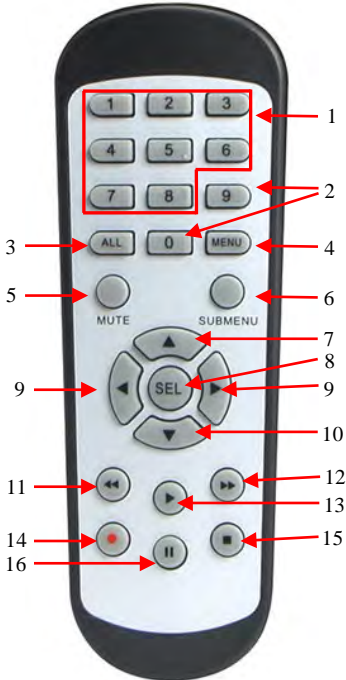

No.	Icon	Description
1	1-8	Numeric keys Press to display channel 1~8
2	9、0	Numeric keys
3	ALL	Press to display all channels Multiple display mode
4	Menu	Press to enter or exit the Main Menu
5	Mute	Mute On/off
6	Submenu	Go to submenu
7	▲	Up arrow key; Volume increase
8	SEL	Press to enter the selected menu item and edit the setting
9	◀ ▶	Left/Right key; Decrease/increase parameter value of control bar.
10	▼	Down arrow key; Volume decrease
11	◀◀	Press to rewind during video playback
12	▶▶	Press to fast forward during video playback
13	▶	Press to play recorded video or enter the recording search menu
14	●	Press to start manual recording
15	■	Press to stop manual recording or stop the video playback
16		Press to pause the video playback or enter frame-playback mode

Table 2-1

Chapter 2 DVR Installation & Connection

2.1 HDD Installation

Depending on the package you have purchased, the hard disk drive may be included in the full package. If it is not pre-installed, follow the installation instructions on this user manual.

**Caution:** DO NOT install or remove the hard disk drive while the device power is turned ON.

HDD Installation:

- (1) Cut power firstly, and then remove screws on both sides & rear panel, and open DVR upper cover.

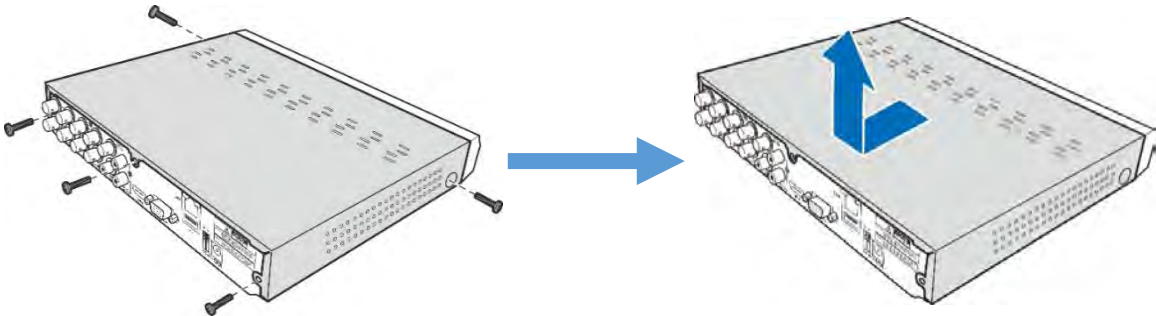

(2) Connect the data and power cables to the HDD and place the HDD on the DVR case. Carefully flip the DVR case and secure the HDD to the DVR with the screws.

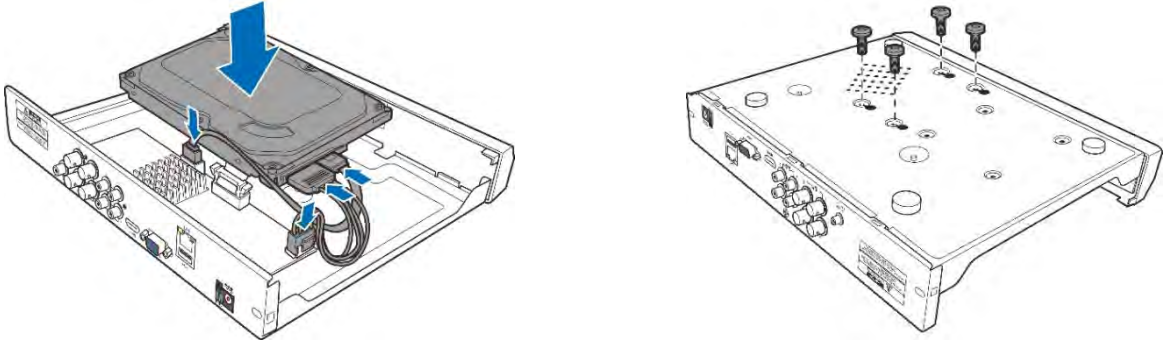

(3) Put the upper cover back carefully, and fix the cover with screws.

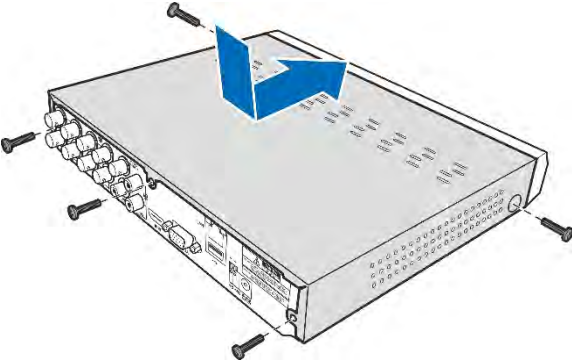

**Note:** Above procedures are for reference only. The practical operation may be different depending on the DVR you purchased.

**2.2 Connection Diagram**

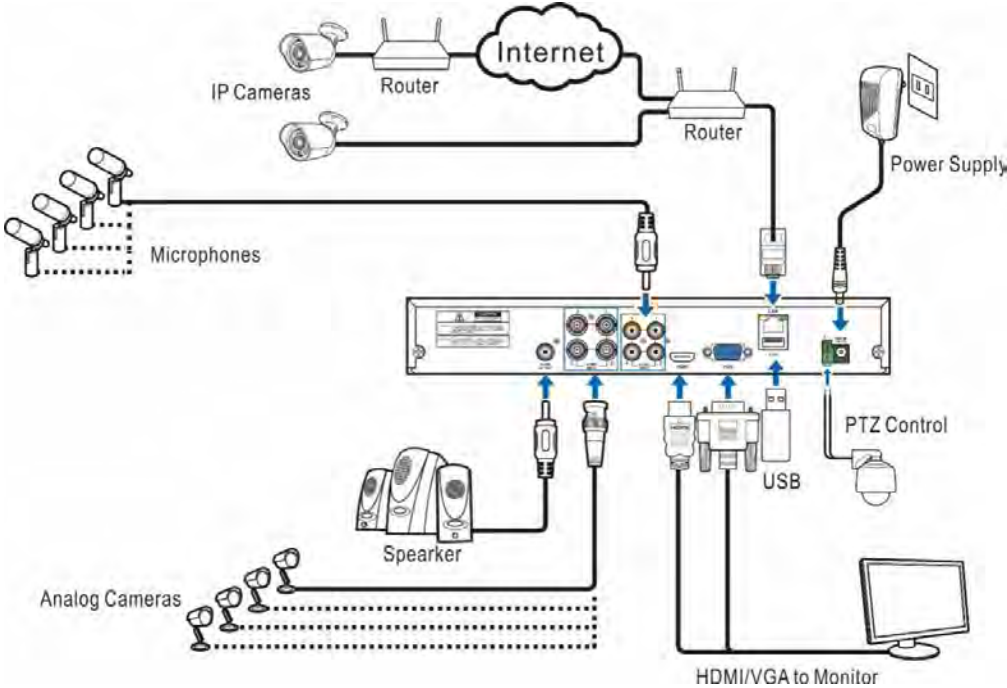

**Note:** Above diagram is for reference only. The practical connection may be different depending on the DVR you purchased.

## 2.3 Power Supply Connection

**Caution:** Use only the supplied power adapter that came with the DVR

Connect one end of the power adapter to the power connector on the back of the DVR. Plug the other end of the power adapter into the wall outlet.

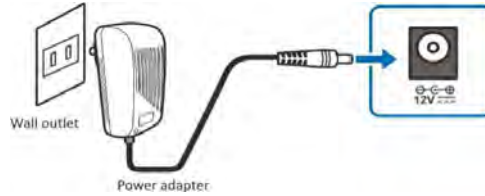

For some specific models, you may need to press the Power switch to turn on the power.

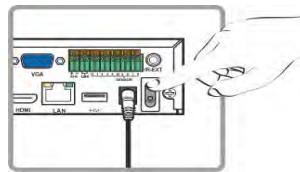

## Chapter 3 DVR Common Operations

### 3.1 Using the Supplied Mouse

1、 Left Button:

- Click to select menu options.
- During live viewing in split-screen view, double-click on a channel to view it in full-screen. Double-click the channel again to return to split-screen viewing.
- Click upon a channel on Live Viewing screen to open Camera Quick Toolbar.
- Click and hold to drag sliders and scales on menu mode

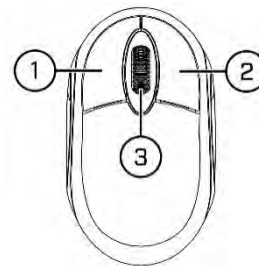

2、 **Scroll** Wheel:

- In menus, scroll to move up / down through the menu content.
- While hovering over the volume control wheel, scroll to turn system volume up / down.

### 3.2 Using the Virtual Keyboard

You will see the virtual keyboard automatically on the screen when you need to enter data

Click to toggle the keyboard to upper case and more punctuation



Click to delete a character

Click to complete the enter

Move the cursor to left

Move the cursor to right

Move cursor to left



### 3.3 Password

The first time you run a DVR, you must immediately set your password to protect your privacy. Be sure to record your user name and password and keep it in a secure place.



**Device ID:** Select the language of the interface

**Device ID:** Enter the device ID in parentheses. The default ID is 000000. For details on the device ID, see 1.1 General configuration 5.7.1 General Configuration.

**New Admin name:** Set up the administrator. Version 8.2.2 cannot modify the administrator user name.

**New Admin Password:** Set up the administrator password. Password should be 8 to 15 characters, not the same as the user name, letters, numbers, special symbols to at least two combinations.

**Confirm Password:** Enter the password for the logged-in user again.

**Unlock Pattern Enable:** Enable the gesture password. Click the edit icon on the right to start setting the gesture password. After two confirmation, you can successfully set the gesture password.



Click **Apply** to confirm the Settings and enter the password recovery Settings page. You can open the corresponding password recovery method by checking the line, or click the **Cancel** button directly without checking, and do not open the password recovery function.

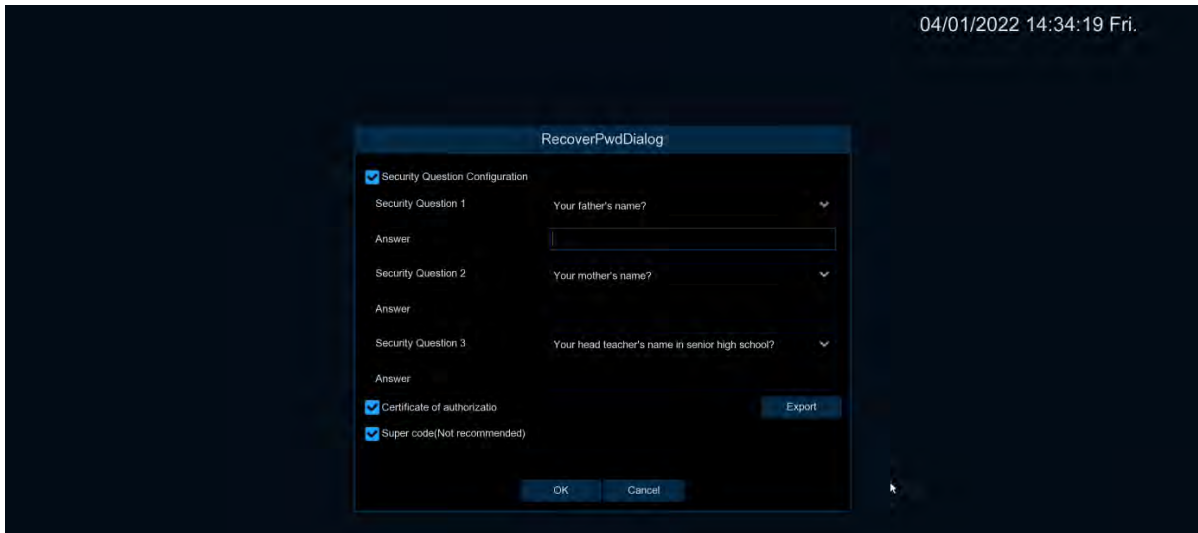



① **Security Question Configuration:** Question check and modify the main user password function. After opening, you need to choose 3 out of 15 common questions, and set the answer required to retrieve the password. The maximum length of the answer is 64 characters.

② **Certificate of authorization:** Use the key to modify the master user password function, and click Export to download the key file certificate. The txt goes to the U disk.

③ **Super code(Not recommended):** Use the super verification code to modify the master user password function, using the current DVR Mac address and DVR system time, to calculate a super verification code that can modify the master user password. However, the Mac address of DVR is broadcast in the network, and the DVR system can be directly obtained when using Super code to modify the main user password during login, so there are certain security risks, so it is not recommended for users to open it.

Then go to the login interface. Enter your username and password Click on **Login** to log in to the DVR system.

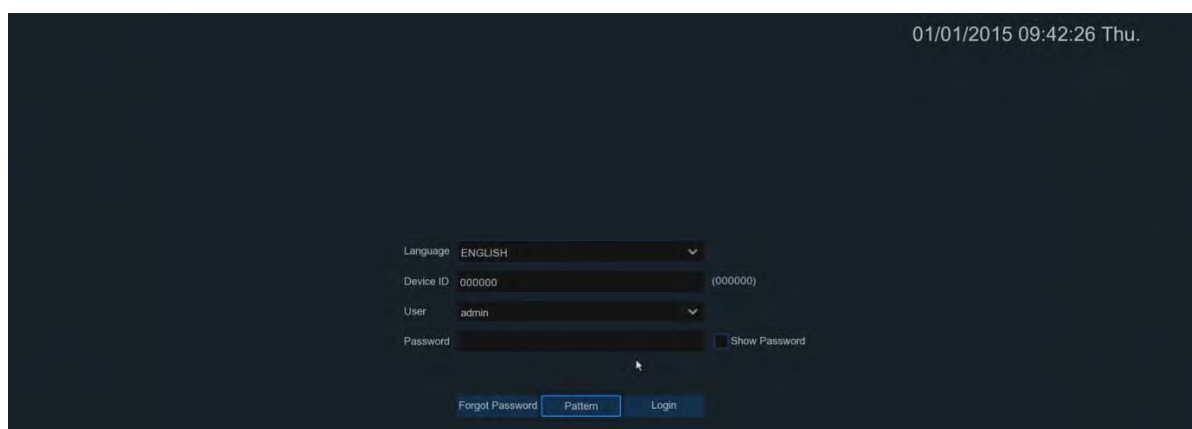

**Pattern:** Enter the gesture and password login interface

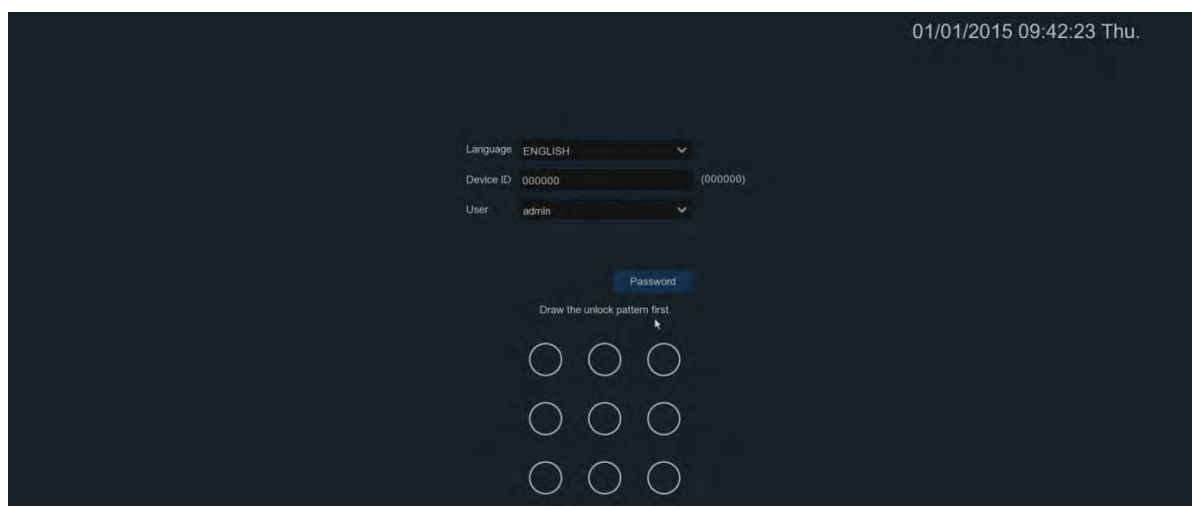

**Notice:**

If you forget two kinds of password, you will not be able to login the system. Please check **Forgot Password** to reset password. System will send the temporary password to the setting email. This password is used on login interface and User setting to change password. If you didn't set the email, please contact your reseller to reset password. (Some models didn't support FORGOT PASSWORD function.)

## Chapter 4 DVR Starting up

### 4.1 Start Wizard

Startup Wizard will help to configure the system and get the DVR works quickly.

#### 4.1.1 Start Wizard

Click the **Start Wizard** to proceed to the next step

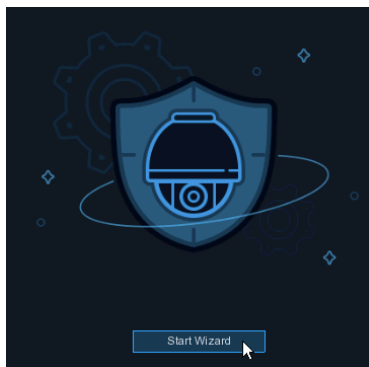

#### 4.1.2 Network configuration

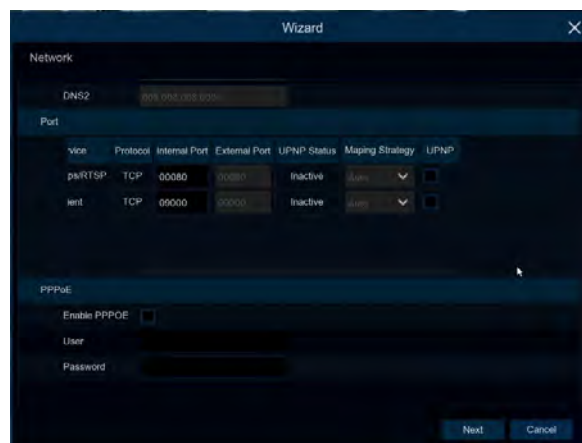
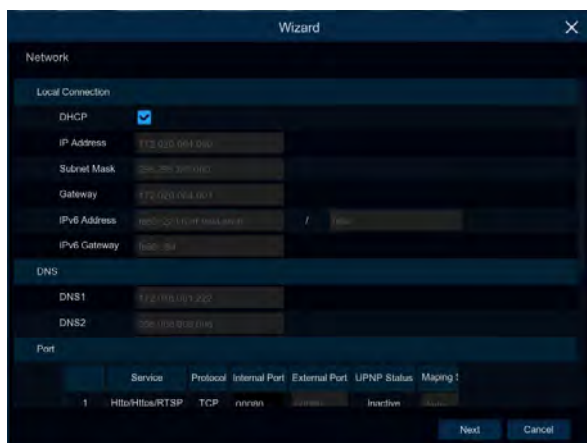

If you connect to a router allows to use DHCP, please check the **DHCP** box. The router will assign automatically all the network parameters for your DVR. Unless the network is manually addressed below parameters:

**IP Address:** The IP address identifies the DVR in the network. It consists of four groups of numbers between 0 to 255, separated by periods. For example, “192.168.001.100”.

**Subnet Mask:** Subnet mask is a network parameter which defines a range of IP addresses that can be used in a network. If IP address is like a street where you live then subnet mask is like a neighborhood. The subnet address also consists of four groups of numbers, separated by periods. For example, “255.255.000.000”.

**Gateway:** This address allows the DVR to access the Internet. The format of the **Gateway** address is the same as the **IP Address**. For example, “192.168.001.001”.

**DNS1/DNS2:** DNS1 is the primary DNS server and DNS2 is a backup DNS server. Usually should be enough just to enter the DNS1 server address.

**Web Port:** This is the port that you will use to log in remotely to the DVR (e.g. using the Web Client). If the default port 80 is already taken by other applications, please change it.

**Client Port:** This is the port that the DVR will use to send information through (e.g. using the mobile app). If the default port 9000 is already taken by other applications, please change it.

**RTSP Port:** This is the port that the DVR will be allowed to transmit real-time streaming to other device (e.g. using a streaming Media player.).

**UPnP:** If you want to log in remotely to the DVR using Web Client, you need to complete the port forwarding in your router. Enable this option if your router supports the UPnP. In this case, you do not need to configure manually port forwarding on your router. If your router does not support UPnP, make sure the port forwarding is completed manually in your router.

**PPPoE (Ethernet-based Point-Point Communication Protocol) dialing:** PPPoE (English: Point-to-Point Protocol Over Ethernet), peer-to-peer protocol on Ethernet, is a network tunneling protocol that encapsulates Point-to-Point Protocol (PPP) in an Ethernet (Ethernet) framework. Due to the integration of PPP protocol in the protocol, the functions of authentication, encryption and compression that cannot be provided by traditional Ethernet can also be used for ethernet protocol such as cable modem (cable modem) and digital user line (DSL).

### 4.1.3 Date/Time

This menu allows you to configure the Date, Time, Date Format, Time Format, Time Zone, NTP and DST.

**Date and Time:** Click on the calendar icon to set the current system date.

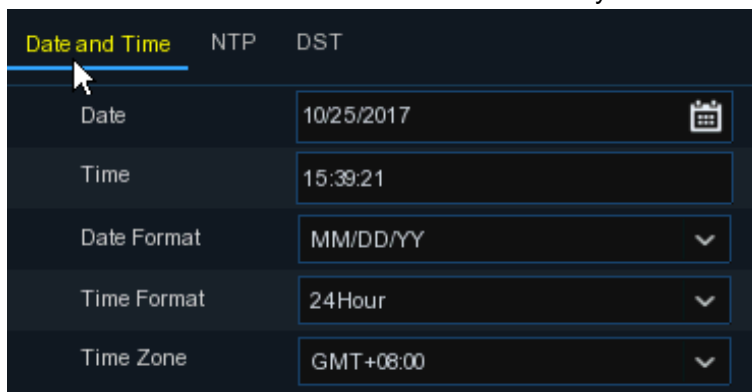

**Date:** Click on the calendar icon to set the system date.

**Time:** Click to set the system time.

**Date Format:** Choose from the dropdown menu to set preferred date format.

**Time Format:** Choose time format between 24Hour and 12Hour.

**Time Zone:** Set the correct time zone.

**NTP:** NTP stands for Network Time Protocol. This feature allows you to synchronize the date and time automatically on the DVR over Internet. Therefore, the DVR needs to be connected to the Internet.

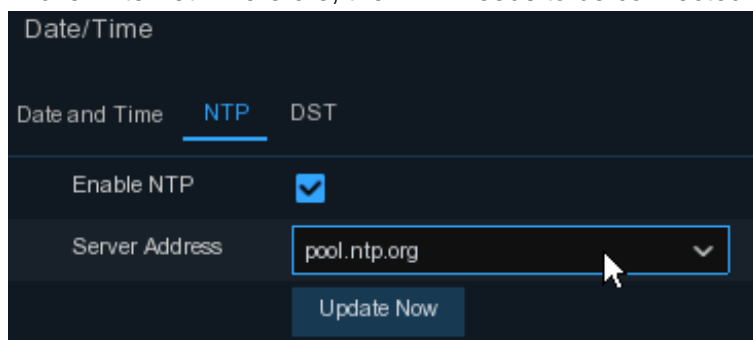

Check the “NTP” box, and select the NTP server.

Choose the server address : time.windows.com,/time.nist.gov/pool.ntp.org/User-Defined

**DST:** DST stands for Daylight Savings Time.

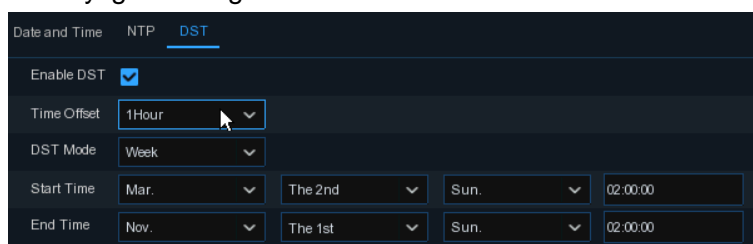

**DST:** Enable if Daylight Saving Time (DST) is observed in your region

**Time Offset:** Select the amount of time to offset for DST

**Time Mode:** Choose to set the daylight-saving time in weeks or in days

**Start Time/End Time:** Set the start time and end time for daylight saving

4.1.4 IP Camera

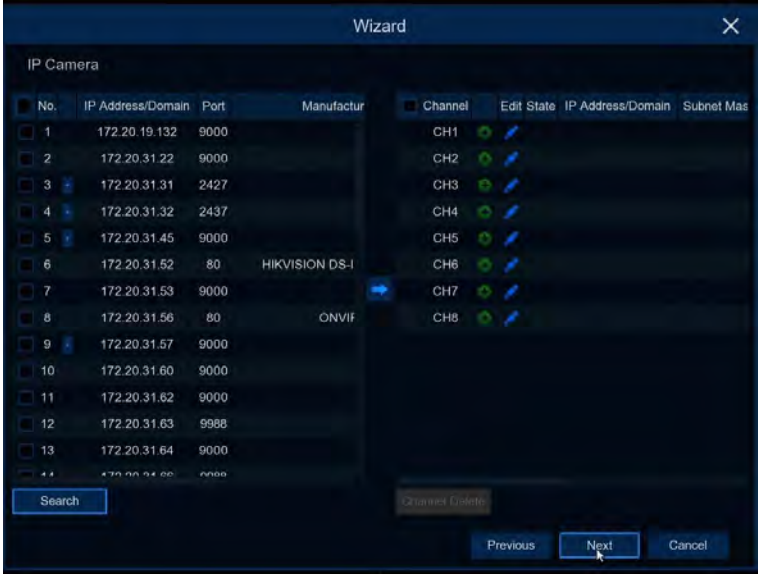

Click **Search** to search IP cameras in the same network. Choose the IP camera(s) you want to add, and then click  icon to add to the DVR

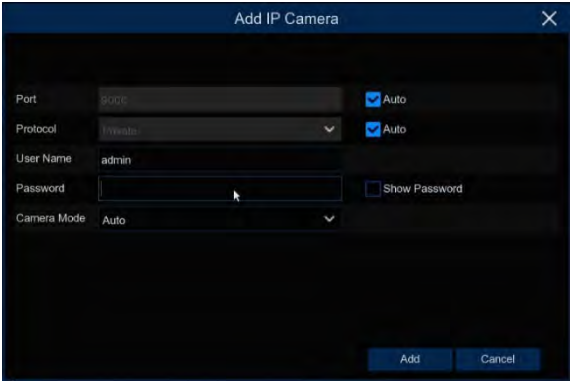

Enter the camera's user name & password to add the camera(s).  
You can also click  button to add individual IP camera to a single channel.  
Click **Search** button to search IP cameras, and then click one of the IP camera in the device list.  
**IP Address/Domain:** IP address or domain name of the IP camera  
**Alias:** Name of the IP camera  
**Port:** Port of the IP camera  
**Protocol:** Choose the protocol of the IP camera from the dropdown menu  
**User Name:** User Name of the IP camera  
**Password:** Password of the IP camera  
**Camera Mode:** Select the IP camera mode in the drop-down menu

### 4.1.5 Disk

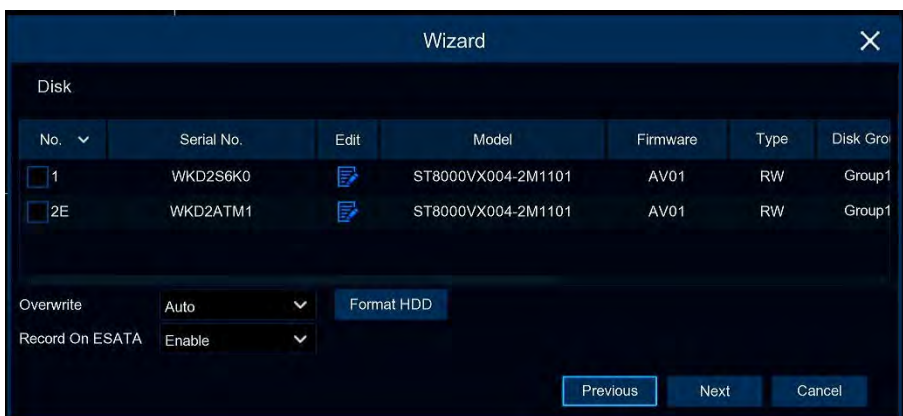

If the HDD is installed in the DVR for the first time, it must be formatted. Select the HDD and then click **Format HDD** button to format the HDD.

**Overwrite:** Use this option to overwrite the old recordings on the HDD when the HDD is full. For example, if you choose the option 7 days then only the last 7 days recordings are kept on the HDD. To prevent overwriting any old recordings, select Disable.

If you have disabled this function, please check the HDD status regularly, to make sure the HDD is not full.

**Record On ESATA:** If your DVR comes with an e-SATA port on the rear panel, you can enable to record the video to e-SATA HDD.

### 4.1.6 Resolution

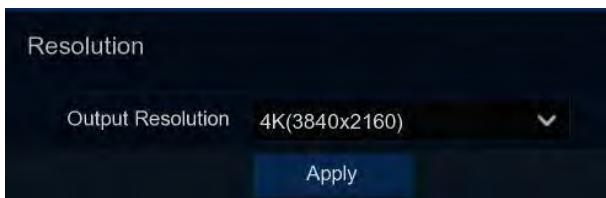

Choose an output resolution matches to your monitor. The DVR supports to adjust the output resolution automatically to match the best resolution of your monitor when the system is starting up.

### 4.1.7 Mobile



If your DVR come with a P2P ID, you can scan the QR code with your mobile app to view the DVR remotely.

### 4.1.8 Summary



You can check the system summary information you had set in the start wizard and finish the wizard. Tick "**Don't show this window next time**" if you don't want to display Start Wizard when system reboot next time. Click **Finish** button to save & exit.



## 4.2 Introduction of the real-time view interface

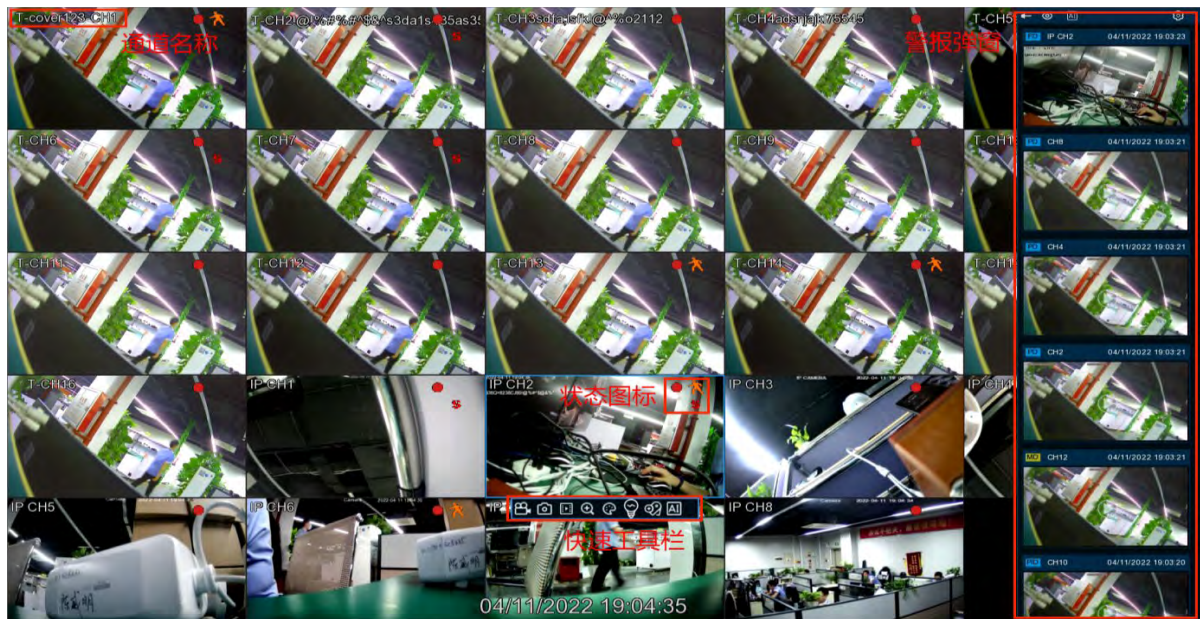

### Camera name

Display the camera name

**A-**: This indicates that the connected camera is an AHD camera

**T-**: This indicates that the connected camera is a TVI camera

**C-**: This indicates that the connected camera is a CVI camera

**IP**: This indicates that the connected camera is an IP camera

### Status icon

**S** : A Smart alert is triggered

**PIR** : It means that the human body infrared sensing alarm is triggered

: This indicates that the channel is being video-recorded

: This indicates triggering the move detection

Show the triggered input and output IO alarm and video recording

: This icon indicates that the hard drive is not working properly

The icon indicates that the hard disk is unformatted

The icon indicates that the hard drive is full

The icon indicates that the hard drive is of a read-only status

**Off-line**: The analog camera is disconnected.

**No Camera**: No IP camera is connected.

**Decoding Failed**: This IP camera compression standard is not supported by DVR, please change to H.264 Compression standard.

**Resource Not Enough**: Insufficient resource, the main code stream does not support and all drawing / mjpeg format can only display one channel.

**Band Not Enough**: Insufficient bandwidth for the channel to go online

**Failed to connect to camera**: The IPC connection has failed

**User name or password error**: Wrong IPC username or password













Click to open the Quick Add menu to add an IP camera

Click to edit the current channel parameters

### 4.2.1 Camcorder Quick Toolbar















In the preview screen, left-click on the attached camera to display the Quick Toolbar.



-  Video recording: Click to manually record the channel immediately. If a manual recording is ongoing, the icon is in red. Click Stop Manual recording again
-  Grab: Click to save a snapshot of the current camera image.
-  Instant playback: Click to play the last 5-minute video of this channel
-  PTZ: Click to enter the PTZ control panel
-  Click to put the channel. Scroll the mouse wheel to zoom the picture and drag the screen.
-  Click to adjust the image color of the channel. You can adjust the tone, brightness, contrast, and saturation of the image.
-   Switch the live video streams between the primary and subcode streams. HD is the main code outflow diagram, and SD is the subcode outflow diagram.
-  Click to manually turn / off the channel white light alarm, see [5.1.8 White Light](#). Also, this menu does not change the parameters within the white light settings.
-  Click to manually turn / off the channel alarm, see section [-5.1.8 White Light](#). Also, this menu does not change the parameters within the white light settings.
-  Label click to add labels
-  Statistics When AI is turned on, hover over the icon to view AI statistics

### 4.2.2 Taskbar



-  Click to Open the Start menu
-  Click to select a different layout to preview the display
-  Click to select more layouts to preview the display
-  Round tour, click to start preview the channel in sequence
-  Quick playback, you can replay all the channels from the start of the day, or click on the lower right triangle to select from the nearest 5s, 10s, 30s, 1Min, 5Min to start the play.
-  Click to adjust the volume
-  Click to switch all IP channels to primary or substreams for a preview
-  Click to switch between the original scale screen or the stretch screen.
-  Click to switch between the balanced or smooth views. Preview mode affects preview video quality only through bit and frame rates, but not the recording quality.
-  There is no connection network
-  This icon appears if the network is disconnected.
-  The network connection was successful
-  Turn the lights and alarms on or off for all channels
-  Start or stop the manual video recording and the manual alarm.
-  View system information, channel information, record information, and network status.

### 4.2.3 The Start Menu

With the Start menu, you can switch between users, search and playback, enter the System Settings menu, lock and unlock the screen, close, restart and log out the system.

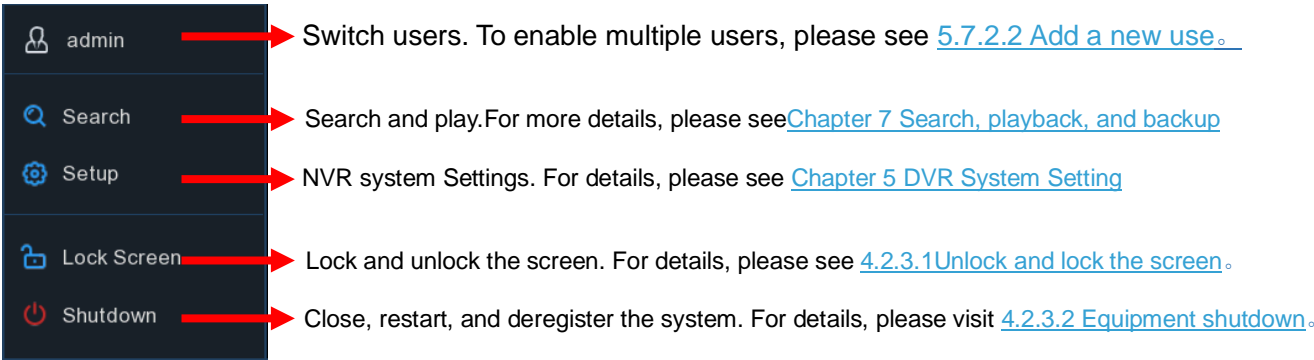

#### 4.2.3.1 Unlock and Lock the screen

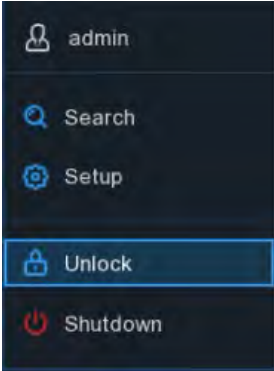

If the NVR is not operated on the Menu for a long time, the screen is locked to protect unauthorized OSD operations. For details, see Menu Timeout (min) in [5.7.1.1 General Configuration](#)

You can also manually lock the screen if necessary. To do this, go to the Start menu and then click the Lock screen icon to lock the system immediately.

If the system is locked, you can click the icon If the system is locked, you can click the icon

#### 4.2.3.2 Equipment shutdown

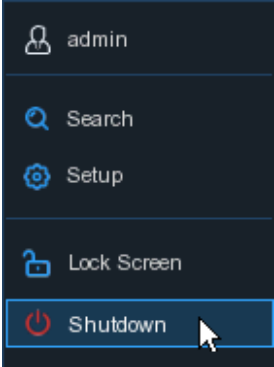

Click the **Shutdown** button from Star Menu, and the check the further action you want to move. Click **OK** button, system will require to input the admin password to authenticate

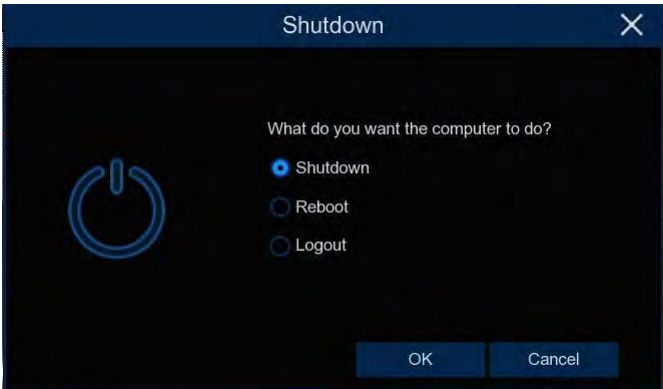

Click the **Shutdown** button from Star Menu, and the check the further action you want to move. Click **OK** button, system will require to input the admin password to authenticate





If you select to log out the system (**Logout**), the live viewing screen disappears. You will need to log in to the system for further operations.

### Chapter 5: DVR System Settings

You can configure channels, records, alerts, network, device, and system parameters, location: **Start Menu** → **Setup**.

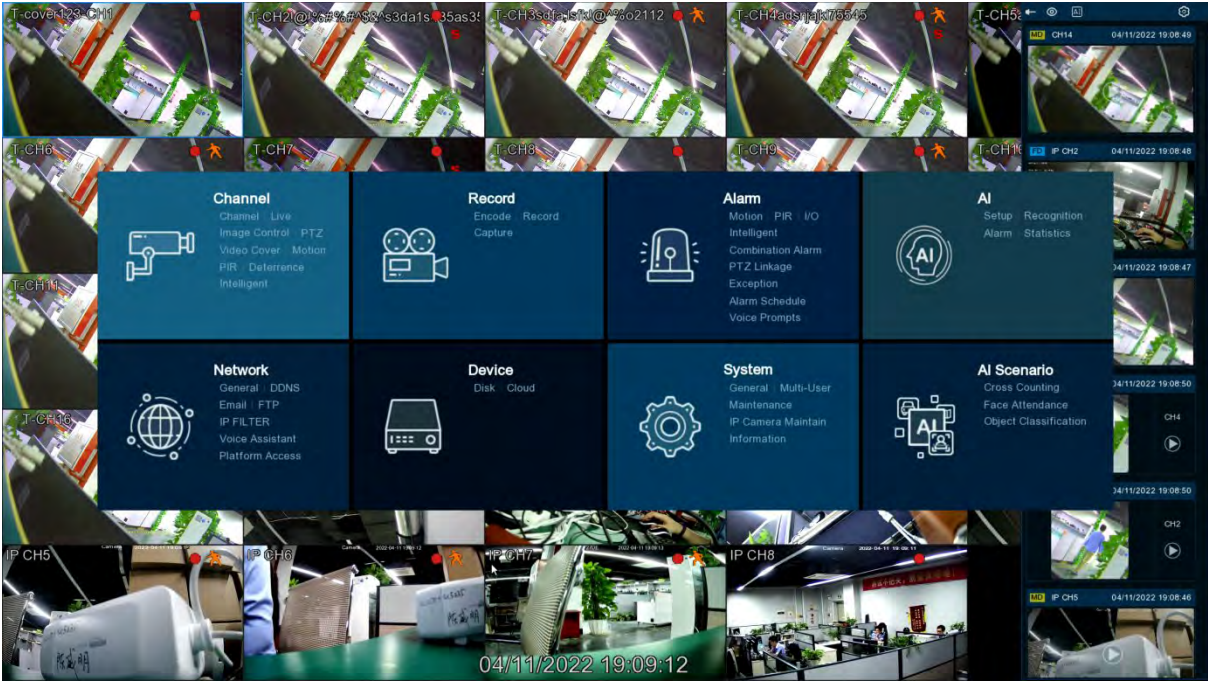

#### 5.1 Channel

In this section, you are allowed to configure the camera, live view display, manage IP cameras, adjust IP camera's image, PTZ setup, motion setup, convert mode, and more.

### 5.1.1 Channel

#### 5.1.1.1 Channel setup

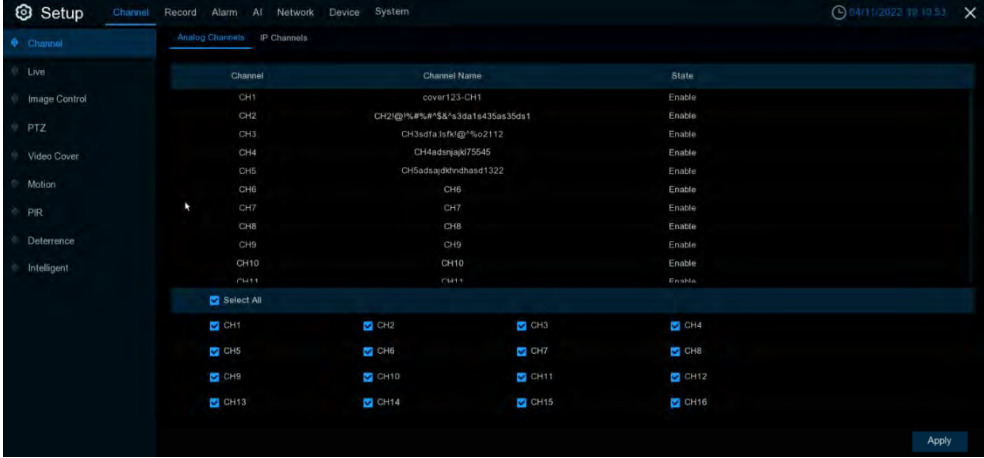

Analog channels and digital channels can be converted to each other. Just select Digital or Analog in the channel you want to convert and save it to take effect. Therefore, you need to enable XVR mode (System->General-> Mode). Please see [5.7.1.1 General Setting](#) for more details.

Moreover, part of the device supports adding wireless channels. Choose the **Wireless**, save, the sub channel will become wireless channel. Choose the **Digital**, it will back to digital channel. Please note, analog channel can't switch to wireless channel.

#### 5.1.1.2 IP Channels

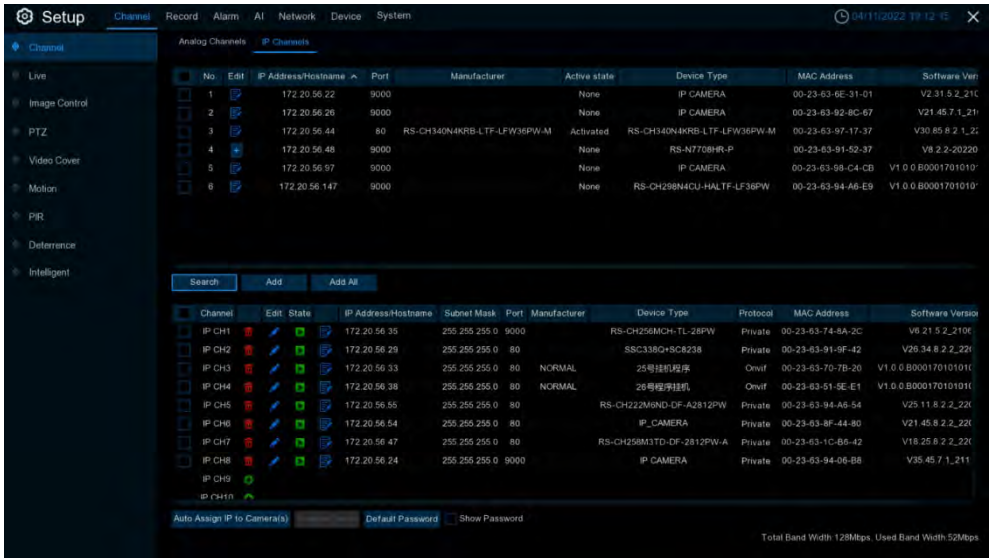

Click **Search** to search IP cameras from local network, click **Add** + to add individual IP camera, click **Add All** to add all IP cameras.

IP Address/Hostname: 172.20.56.147

Alias: IP CH8

Port: 9000

Protocol: Private

User Name: admin

Password: .....

Bind channel: IP CH8

Buttons: Search, Default Password, Add, Cancel

Click **Search** button to search IP cameras, and then click one of the IP camera in the device list.

**IP Address/Domain:** IP address or domain name of the IP camera

**Alias:** Name of the IP camera

**Position:** Position to display the camera name on the screen.

**Port:** Port of the IP camera

**Protocol:** Choose the protocol of the IP camera from the dropdown menu

**Connect Mode:** When you select the onvif protocol, select **General** or **Security** from the drop-down menu. **General** represents http connection onvif; **Security** representative first asks if IPC supports https, if supported, provide certificate, https, if not, http.

The screenshot shows the 'Edit Connection Information' dialog box with the following fields:

Channel	IP CH8
Alias	IP CH8
IP Address/Hostname	172.20.56.24
Subnet Mask	255.255.255.000
Port	9000
Protocol	Onvif
Connect Mode	General
User Name	admin
Password	••••••••

Buttons: OK, Cancel

**Mainstream URL:** When you select the RTSP protocol, fill the primary stream RTSP address to connect to the IPC.

**Substream URL:** When you select the RTSP protocol, fill the substream RTSP address to connect to the IPC.

The screenshot shows the 'Edit Connection Information' dialog box with the following fields:

Channel	IP CH8
Alias	IP CH8
Mainstream URL	
Substream URL	
Protocol	RTSP
User Name	admin
Password	••••••••

Buttons: OK, Cancel

**User Name:** User Name of the IP camera

**Password:** Password of the IP camera

**Bind channel:** Choose a channel of the DVR you want to attach to

**Auto Assign IP to Camera(s):** The added IP camera would be not able to connect if its IP address is not in the same network segment with DVR. With this function to reassign an IP address to all added IP cameras.

**Channel Delete:** Choose one or more added IP cameras, and click this button to delete.

**Default Password:** To set IP camera's default password

Click Edit icon and enter the IP camera edit menu.

**Show Password:** Enter the DVR password, which can clearly display the password of the connection IPC set by each channel.

5.1.2 Live

Configure the video camera parameters.

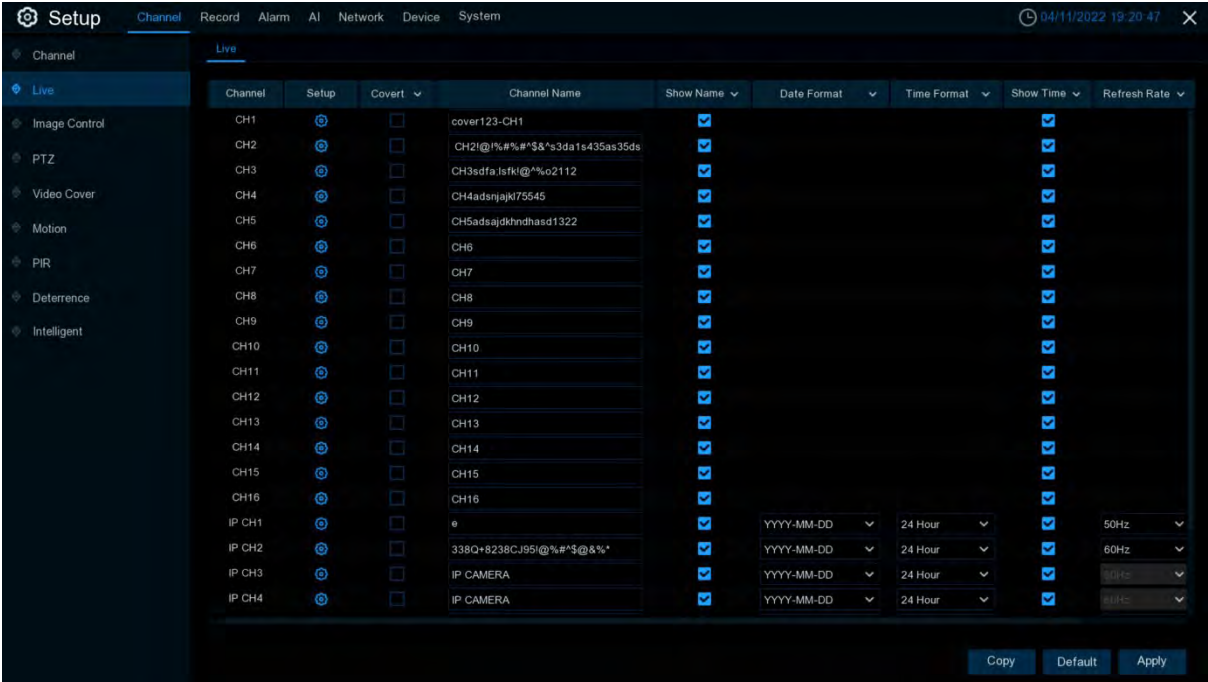

**Channel:** Display channel name.  
**Setup:** Click icon into the setup page.

- Channel: CH1 → Select the channel
- Channel Name: Camera → Name the channel
- Date Format: DD/MM/YYYY → The date format displayed by the camera
- Time Format: 24 Hour → Time format displayed by the camera
- Refresh Rate: 60Hz → Camera refresh rate
- Show Name → The camera name is displayed in the preview
- Show Time → The system time is displayed in the preview
- Alpha: 64 → Text transparency
- HUE: 128 → Adjust the tone of the image color
- BRIGHT: 128 → Adjust the brightness of the image color
- CONTRAST: 128 → Adjust the contrast of the image color
- SATURATION: 128 → Adjust the saturation of the image color

Click Default to restore the Default Settings of image color, click Apply to save the Settings, and right-click to exit.



5.1.3 Image control

This menu allows you to control image settings for supported IP cameras.

Channel	Setup	Image Setting	IR-CUT Mode	IR-CUT Delay	Lens Flip	Angle Flip	Angle Trad	BLC Level	3D Noise Reduction	DWDR	AGC	White Balance	Time Exposure
IP CH1			GPIO Auto	2	OFF	OFF	0	OFF	Auto	OFF	Middle	Auto	Auto
IP CH2	Day/Night Mode		Automatic mode	2	OFF	OFF	0	OFF	Auto	OFF		Auto	Auto
IP CH3			GPIO Auto	1	OFF	OFF	0	OFF	Disable	OFF	OFF	Auto	Auto
IP CH4			GPIO Auto	1	OFF	OFF	0	OFF	Disable	OFF	OFF	Auto	Auto
IP CH5			GPIO Auto	2	OFF	OFF	0	OFF	Auto	OFF		Auto	Auto
IP CH6			GPIO Auto	2	OFF	OFF	180	OFF	1	OFF		Auto	Auto
IP CH7			Color Mode	2	OFF	OFF	0	OFF	Auto	OFF		Auto	Auto
IP CH8			GPIO Auto	2	OFF	OFF	180	OFF	Auto	OFF		Auto	Auto

**Channel:** Channel name

**Setup:** Click to enter the Settings page

- Channel: CH3
- IR-CUT Mode: GPIO Auto
- IR-CUT Delay: 2
- IR-LED: Auto
- Lens Flip:
- Angle Flip:
- Corridor Mode:
- Angle Trad: 0
- Back Light: Enable
- BLC Level: Middle
- 3D Noise Reduction: Manual
- Level: 128
- WDR: Enable
- Level: 128
- AGC: Middle
- White Balance: Auto
- Shutter: Auto
- Time Exposure: 1/25
- Defog Mode: Disable

- Choose a channel to configure
- Select the desired built-in IR cut filter mode to ensure the camera works properly both in the day and night.
- Set the delay time of IR-CUT switching
- Set IR-LED mode, there are OFF, ON, Auto, two sets of INFRARED light IPC more. Out of the Manual option, you can manually adjust the brightness of two sets of infrared lamp manual.
- Check to enable lens flip, Angle flip, and corridor mode
- Check to enable lens flip and angle flip
- To enable or disable Backlight compensation
- Choose the backlight compensation level
- To enable or disable 3D noise reduction function
- Set the 3D noise reduction level
- Enable to allow automatically adjust the brightness and contrast of the video when shooting in the darkness with bright light sources.
- Set the WDR level
- Automatic Gain Control
- Configure white balance
- Set the shutter mode
- Choose the exposure time of the camera
- Use in foggy environments to improve the video quality

### 5.1.4 PTZ

This menu allows you to configure the PTZ (Pan-Tilt-Zoom) settings for the dome camera

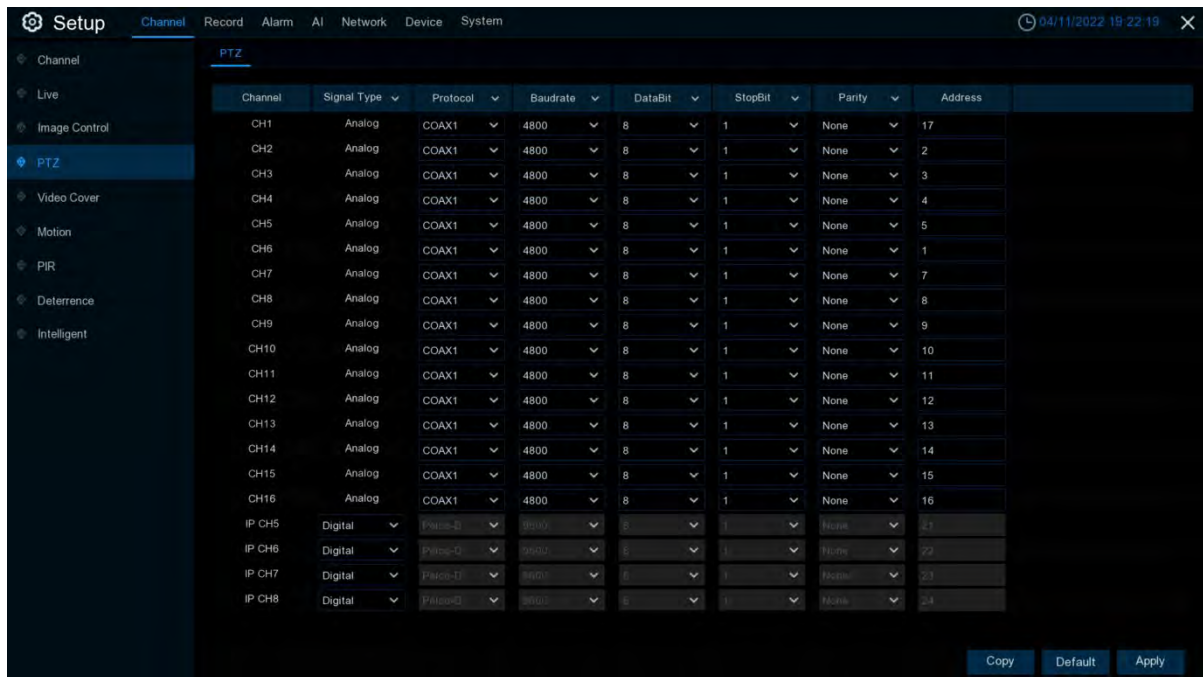

**Channel:** Channel name

**Signal Type:** Analog for analog channels, Analog & Digital for IP channels.

**Protocol:** Choose the communication protocol between the PTZ capable camera and DVR. If your camera support UTC (Up the Coax) function, you can choose COAX1 or COAX2 to display your camera OSD menu or control the UTC PTZ function.

**Baudrate:** The speed of the information sent from the DVR to the PTZ-capable camera. Make sure it matches the compatibility level of your PTZ-capable camera.

**DataBit / StopBit:** The information between the DVR and PTZ-capable camera is sent in individual packages. The **DataBit** indicates the number of bits sent, while the **EndBit** indicates the end of the package and the beginning of the next (information) package. The available parameters for **DataBit** are: **8, 7, 6, 5**. the available parameters for the **StopBit** are **1** or **2**.

**Parity:** For error check. See the documentation of your PTZ-capable camera, to configure this setting.

**Address:** Set the command address of the PTZ system. Please be noted that each PTZ-capable camera needs a unique address to function properly

### 5.1.4.1 PTZ control

With the PTZ setup complete, you can use the PTZ feature to control the high-speed ball machine

Click the left mouse button on the Live View screen channel to open the [4.2.1 Camcorder Quick toolbar](#), then select the PTZ Control icon, and click the icon will display the PTZ control panel.

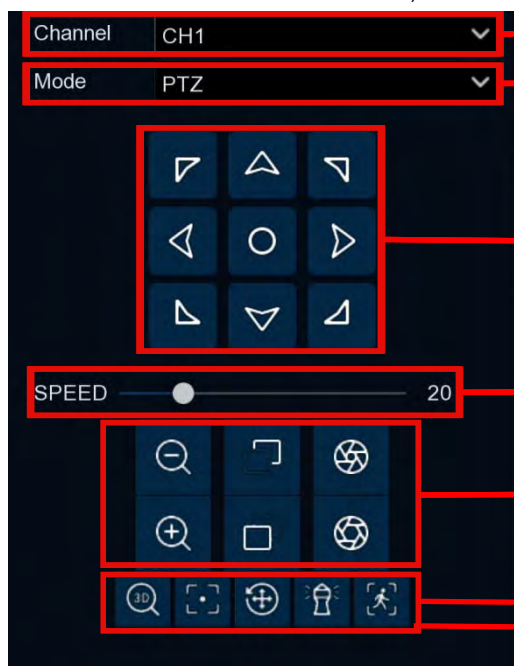

Selective channel  
 Cloud head rotation mode, with PTZ, PRESET, Line Scan, Watch Mode, Tour, Pattern Scan six modes

Click the button in the middle, the ball machine will continue to rotate horizontally; Long press the direction keys around to control the horizontal and vertical rotation of the head

Click the middle button, the ball machine will continue to rotate horizontally; long press the directional button to control the horizontal and vertical rotation

The first vertical row icon is the lens close, pull far, corresponding to the scene amplification, shrink; The second vertical row icon is the lens focus, click to adjust

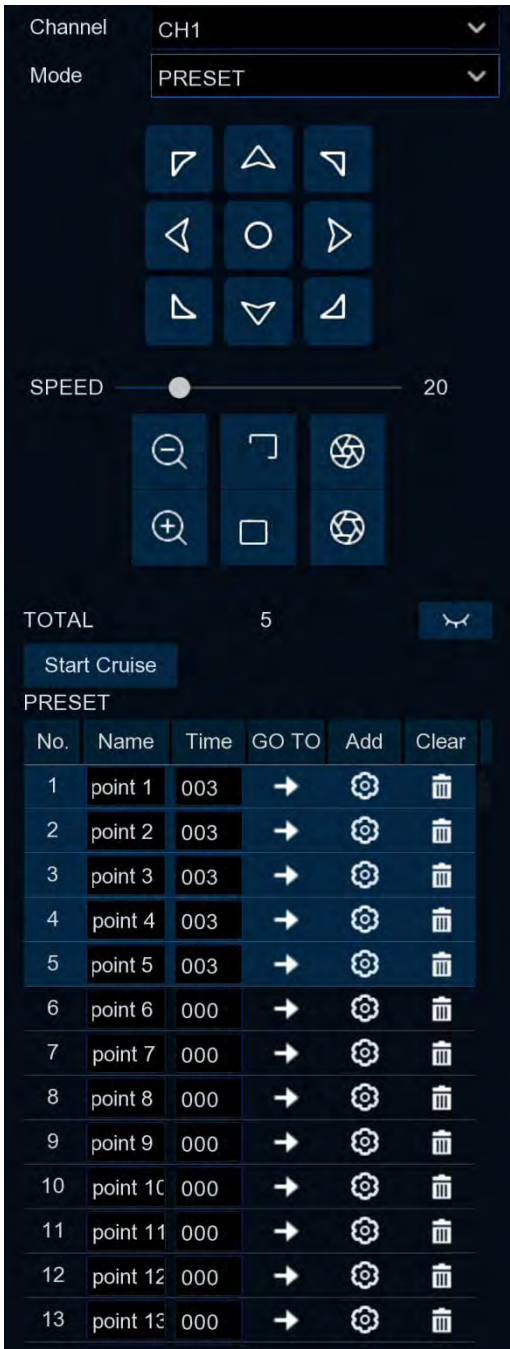

The first icon is 3D PTZ, click open by clicking the picture to click the image position, can also turn through the box to the box to select the image position and zoom in / out the image, from left to right to the selected position and to the corresponding magnification, from right to left to the selected position and to the corresponding ratio;  
 The second icon is automatic focus, click to automatically adjust the clarity of the scene; The third icon is to reset the preset point, click will reset the set preset point;  
 The fourth icon is the watch mode, click will start the watch position according to the set watch position action;  
 The fifth icon is the manual tracking mode. After clicking on the preview screen, use the left mouse button box to select the tracking target. The high-speed ball can automatically position the target always in the center of the view, and the tracking target disappears or click the tracking button again to exit the tracking mode.



**PRESET mode page:**

Click  the screen showing the preset point under the preview screen, as shown below;



Click  or "Add preset point"  in the figure above, the preset point screen will be displayed at the bottom of the preview interface, and the preset point will be displayed on the left. The preset point will be displayed in dark color, and the preset point will be displayed in gray color.

Click  to rotate to the position set by the preset point and take the shortest path;

Click the Name box to modify the preset point Name, click the Time box to modify the cruise stay Time at the preset point;

Click  delete preset point;

Click Start Cruise to Start the Cruise.

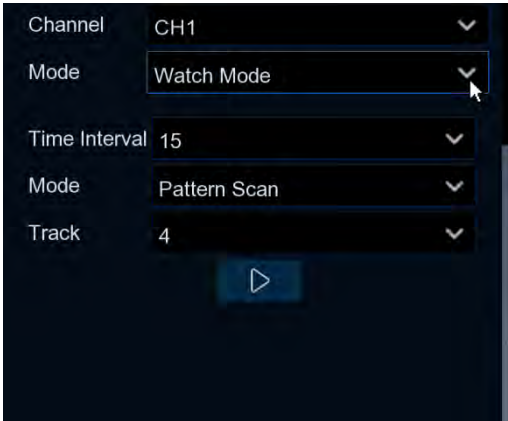

**Watch Mode page:**

Time Interval: wait Time of the watchposition. It is the Interval between stopping operations and resuming operations of the watchposition.

Mode: Select the watch Mode, can choose the default, preset point, linear scan, track cruise, pattern scan;

Click  to start cruising



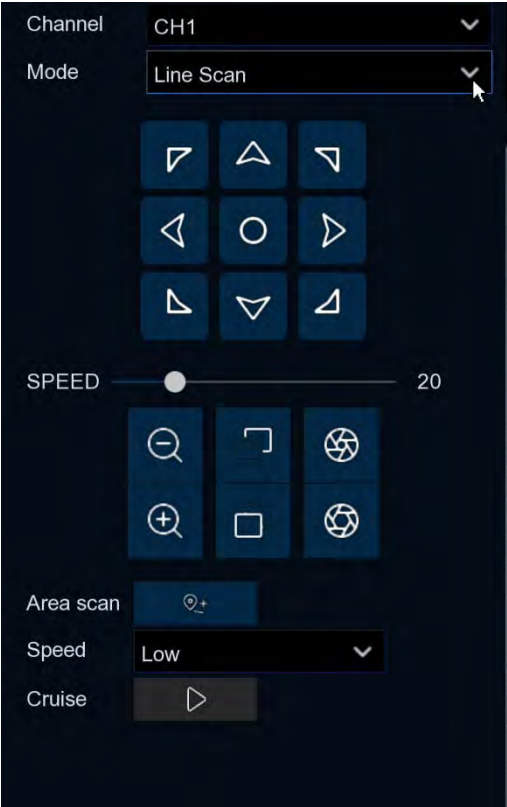

Line Scan page:

Area Scan: Click [location pin icon] record start position, rotate the ball machine, click [location pin icon] record end position;

Speed: Select a linear cruising Speed.

Click [play icon] to start linear cruise. In this mode, the ball machine only moves in the same horizontal plane.



Tour page:

Time Interval: indicates the stay Time of each preset point



Click [plus icon] Add preset point, click [trash icon] Delete preset point,

click [up arrow icon] / [down arrow icon] Move up/Move down preset point,

Click [play icon] to start cruising.



Pattern Scan page:

Record: Click  to start recording cruise route, click  to stop recording.

Cruise: Click  to start a Cruise using the route and action previously recorded.

### 5.1.5 The Privacy Area

This menu allows you to create privacy areas, and if you want to partially cover certain specific parts of the image, you can create up to 4 privacy areas of arbitrary size and location. Enable the privacy areas, and select how many privacy areas are required. The area appears as the Red Box. Click the edge of the red box and drag it to any size to create a privacy area.

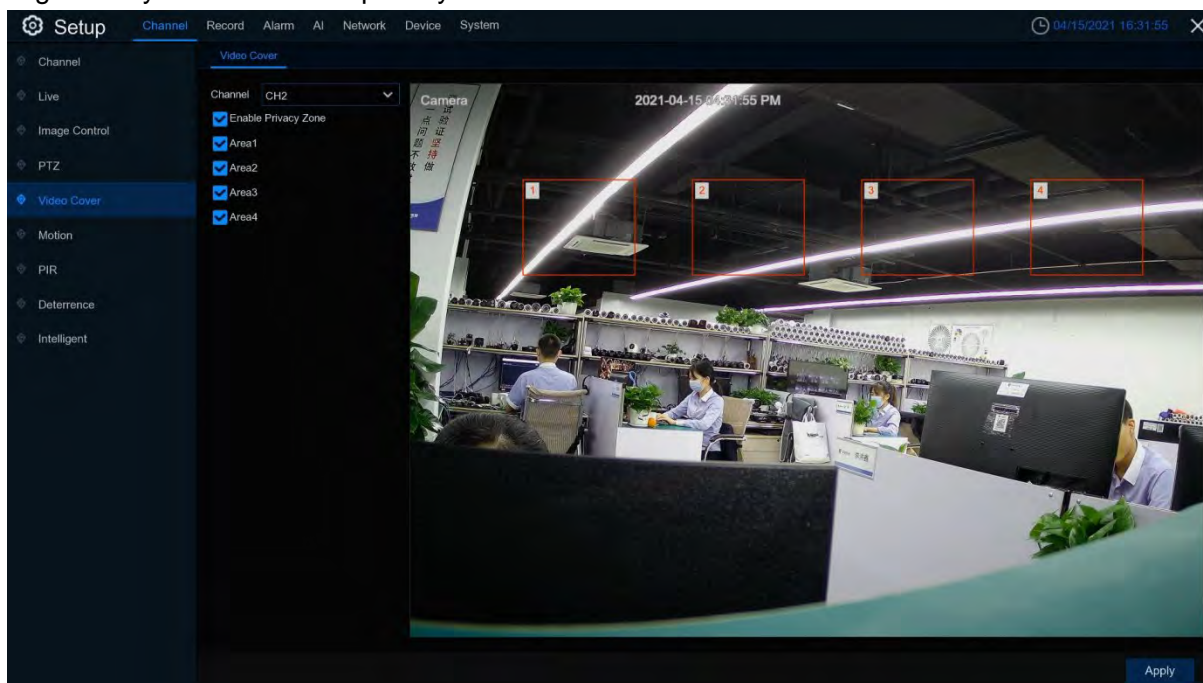

**Private Zone (Private space)** : Open or close the private space, if open, you can cover the set meaning area, you will not see the covered area in the preview.

**Area map** : You can set up to four private space areas in the area map, four areas can be moved, stretch, click apply to save the effect

**Note** The privacy area you set is not visible when previewing and recording the video. .

### 5.1.6 Motion

This menu allows you to configure motion parameters. When motion has been detected by one or more cameras, your DVR will alert you to a potential threat at your home. It does this by sending you an email alert with an attached image from the camera to use as a reference (if this option is enabled) and/or sending push notifications via the mobile app.

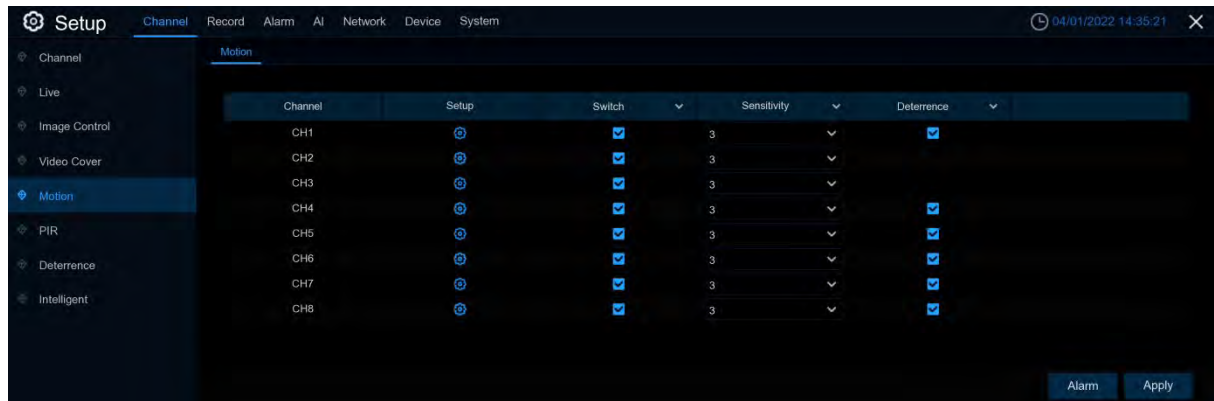

**Switch:** Enable or disable mobile detection.

**Sensitivity:** Set the sensitivity level. Level 1 is the lowest sensitivity level, while level 8 is the highest sensitivity level.

**Deterrence:** Turn the associated white light alarm on and off

**Settings:** Click the icon  to enter the setup page

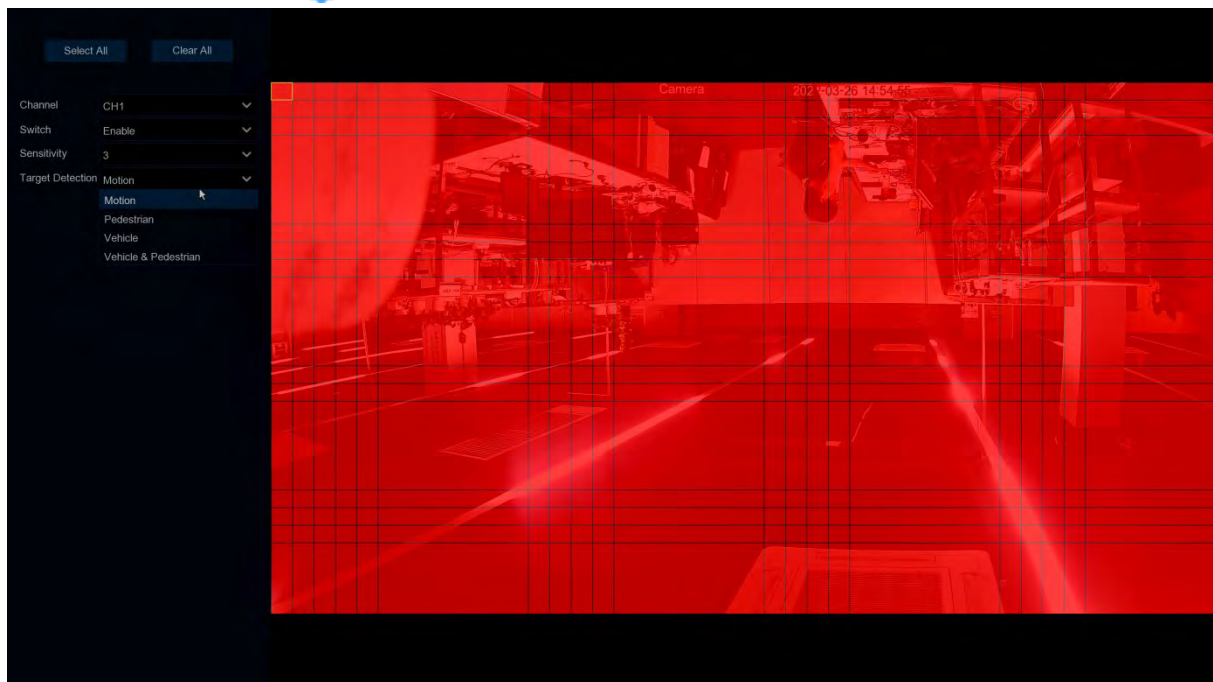

**Target Detection:** Select the detected target type. There are four options of **Motion, Pedestrian, Vehicle, Vehicle & Pedestrian**.

**Move the detection area:** Click **Select All** to set the entire screen of the camera to the mobile detection area; click **Clear All** to clear the entire area.

If you want to edit the size of the area, select the box and change the location.

When the settings are complete, right-click back, and then click **Apply (Save)** for the locale to take effect.

Return to the main interface, click the **"Alarm"** button to configure the motion detection alarm function, please see [5.3.1 motion detection alarm](#) for details

5.1.7 PIR

This is an optional function. If your camera has PIR function, you can configure the PIR recording here.

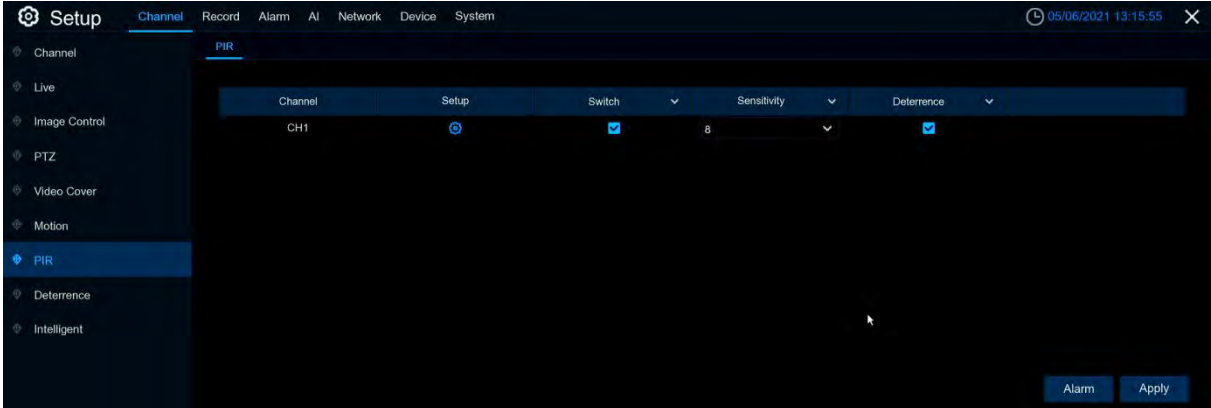

The PIR alarm menu, when the PIR alarm is triggered, it will send the alarm by mail and APP push, just like motion

**Switch:** Enable or disable PIR detection.

**Sensitivity:** Set the sensitivity level. Level 1 is the lowest sensitivity level, while level 8 is the highest sensitivity level.

**Deterrence:** Turn the associated white light alarm on and off

**Setup:** Click  to enter the Settings page

**PIR detection area**

Click **Select All** to set the whole screen of the camera as PIR detection area. Click **Delete All** to clear the area.

You can also set an area in the screen by drawing a pentagon in the screen.

If you want to edit the size of the area, please check the box and change the position.

After setting is completed, click the right button of your mouse to return and click **Save** to make the area setup effective.



Return to the home screen and click the **Alarm** button to configure the PIR alert function. See for details [5.3.2 PIR Alarm](#)

5.1.8 White Light

The parameters related to the white light alarm can be set here

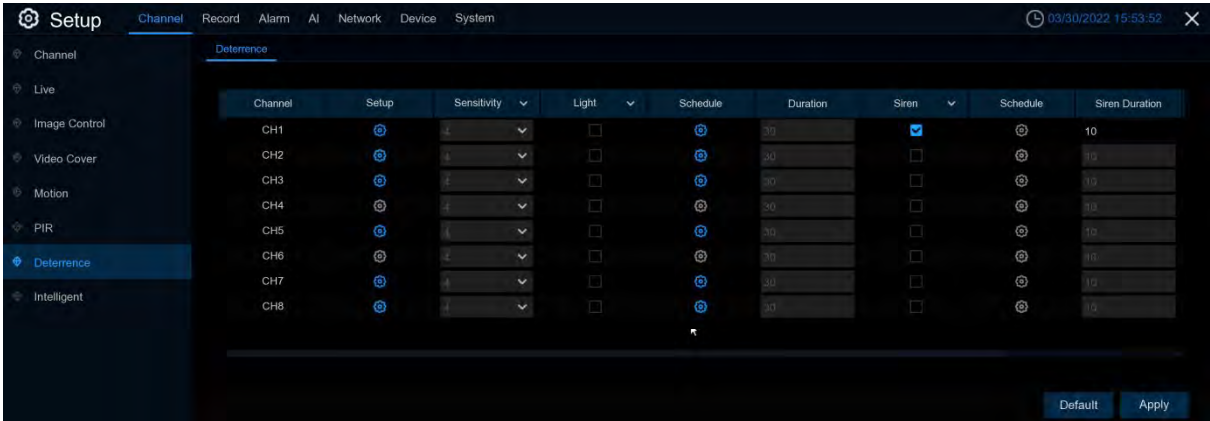



**Channel:** Channel name

**Setup:** Click the icon  to enter the setup page.

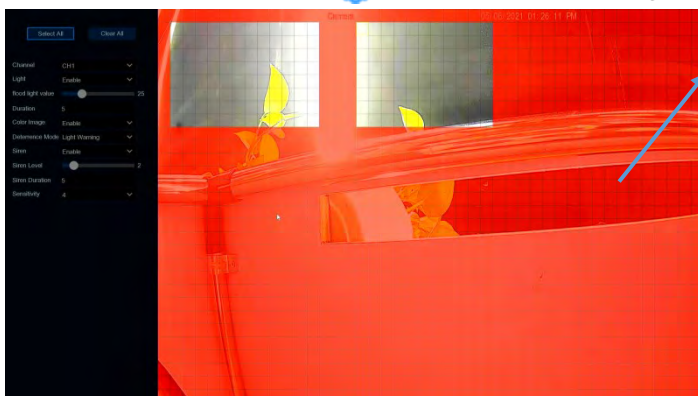

**White light deterrent area:**

Click **Select All** to set the entire screen of the camera to the white light deterrent area. Click **Clear All** to clear the entire area.

If you want to edit the size of the area, check the box and change the location.

When the Settings are complete, right-click to return, and then click Apply to make the locale Settings take effect

**Light Switch (light switch):** Turn the light warning on or off.

**Flood light valve:** Adjust the brightness level of the white light

**Duration:** The duration when the white light is on

**Color Image:** Turn the color screen on or off. (Note: When turned on, triggering white light deterrence at night will switch the picture from night view black and white to color mode)

**Deterrence Mode:** Set white light mode, bright mode Light Warning and flashing mode Light Strobe

**Strobe Frequency:** The flicker frequency of the white light

**Siren Switch (alarm switch):** enable / disable the alarm warning.

**Siren Level:** White light alarm sound volume level

**Siren Duration:** Sound duration of the white light alarm

Sensitivity, (Sensitivity) sets the sensitivity level. Level 1 has the lowest sensitivity, and level 8 has the highest sensitivity.

**Schedule (schedule):** Click the icon  to open the setup page.

When the IPC connects to the DVR with a media port, the setting page is shown below:

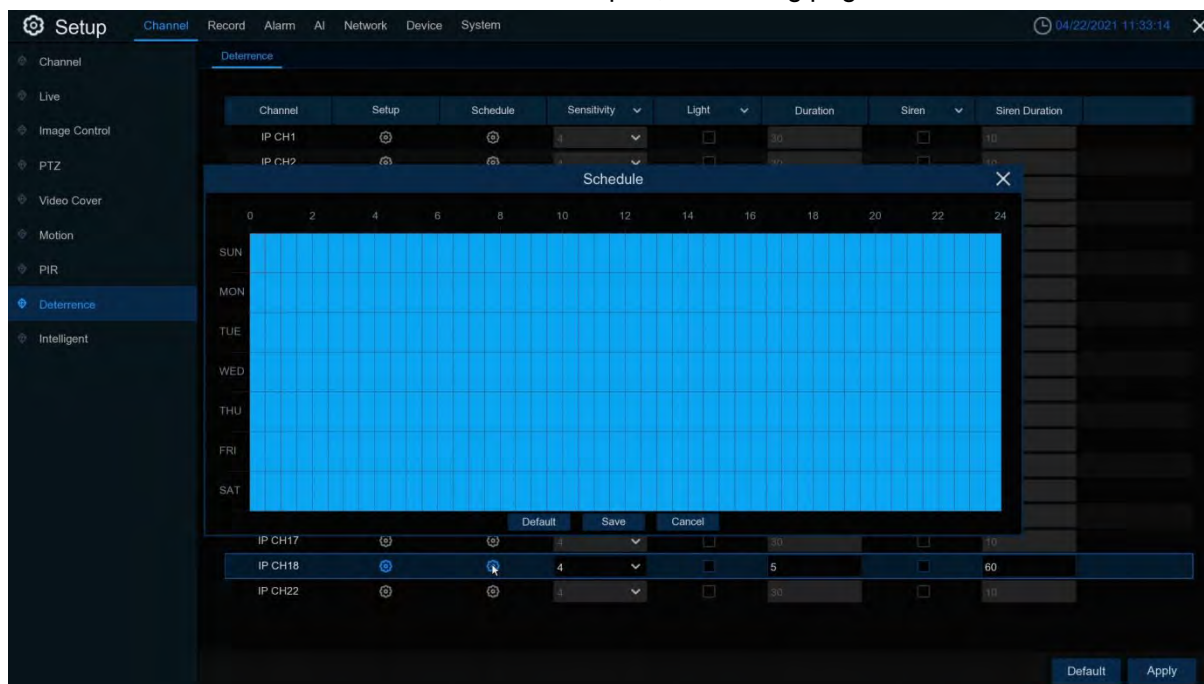

When the schedule is marked in light blue, the channel can trigger a white light deterrent alarm for the time slot.

**Default:** Restore the default settings.

Note: Open the Deterrence correlation switch in the Motion or PIR setting to trigger white light when motion or PIR is triggered.

When the IPC connects to the DVR with the WEB port, the setting page is shown below:

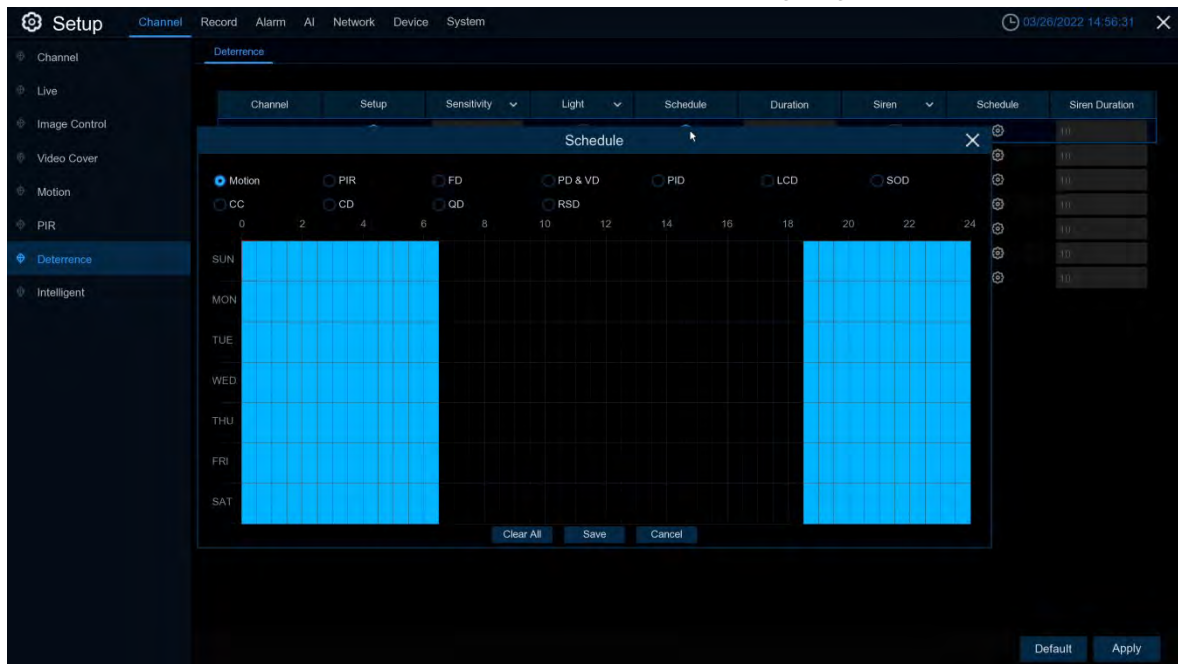

The effective time of the white light / alarm linkage alarm of the corresponding function can be set by using the selected function paging.

**Clear All:** Clear the light blue tags for all subpages

### 5.1.9 Intelligent (Intelligent Analytics)

Optional intelligent analysis includes perimeter intrusion detection, line-crossing detection, still life detection, pedestrian detection, face detection, line-crossing statistics, sound detection alarm and occlusion alarm

#### 5.1.9.1 PID (Perimeter intrusion detection)

Perimeter Intrusion Detection function detects people, vehicle or other objects which enter and loiter in a pre-defined virtual region, and some certain actions can be taken when the alarm is triggered.

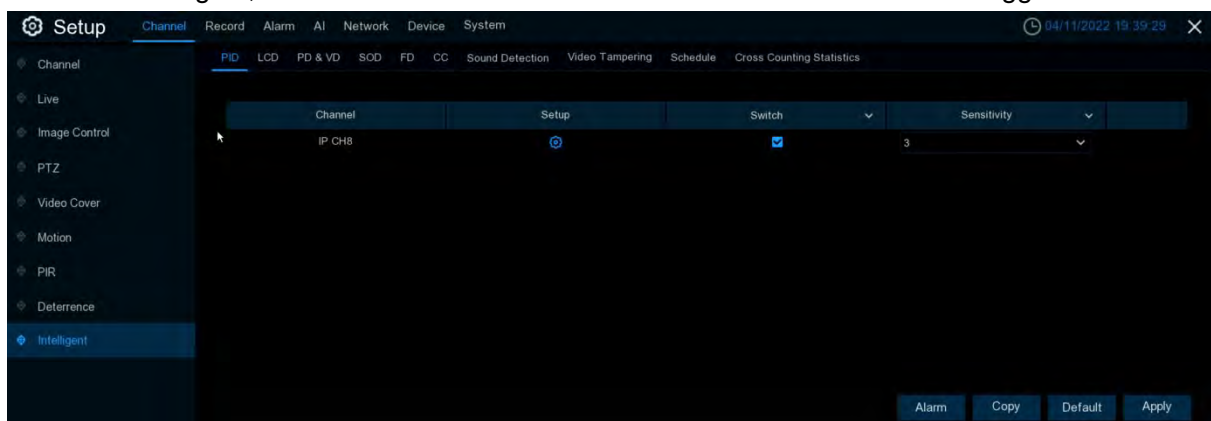

**Switch:** Turn on or disable this function

**Sensitive:** sensitivity, parameter range 1~4, default value 2, the higher the sensitivity of the detection target, the easier the moving target in the channel will be detected, and the more misdetection, the corresponding missing detection will be reduced, it is recommended to maintain the default value

**Area:** Click **Setup**  to row the virtual area in the image

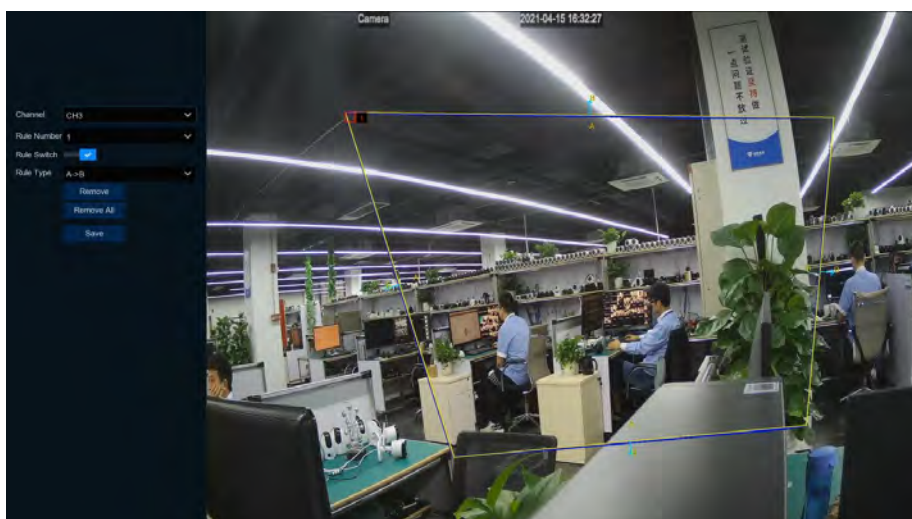

1. **Channel:** Select the channel that you want to configure
2. **Rule Number:** You can set four rules, draw rule areas on the area map and point to the few rules, then you can draw rules on the area map. The Rule Switch (rule switch) and Rule Type (rule type) of each rule are independent, and need to be turned on, off or set separately
3. **Rule Switch:** 3.Enable detection in the rule switch.
4. **Rule Type:** Select a rule type,
  - A B: DVR only detects movements from side A to side B;
  - B A: DVR only detects movements from side B to side A;
  - A B: DVR will detect the action from plane B to plane A or from plane A to plane B;
5. Click on 4 points in the camera image to draw a virtual area. The sharpness of the region should be a convex polygon. The concave polygons cannot be saved.
6. Click **Save** to save the settings.
7. If you want to change the location or shape of the area, click the red box in the area, and the border of the area turns red. Press the left mouse button to move the area, or drag the corner to resize the area.
8. If you want to remove an area from the camera picture, click the red box in the area, and then click the **Remove** button. Clicking **Remove All** will remove all areas.

#### CAUTION:

- 1)The periphery is not too close to the edges / angles of the camera image as it may not trigger detection when the target passes through the edge / angle.
- 2)The shape of the region cannot be too narrow / too small because detection may not be triggered when the large target crosses the perimeter.



Click the **Alarm** button to configure perimeter intrusion alarms for details at [5.3.4.1 PID \(Perimeter intrusion alarm\)](#)

(Note: trigger PID (perimeter intrusion detection), "S" will appear on the preview interface, in addition, PID and LCD / SOD are not mutually exclusive, can be opened at the same time, mutually exclusive with PD / FD / CC, not open at the same time)



### 5.1.9.2 LCD (Line Crossing Detection)

Line Crossing Detection function detects people, vehicle or other objects which cross a pre-defined virtual line, and some certain actions can be taken when the alarm is triggered.

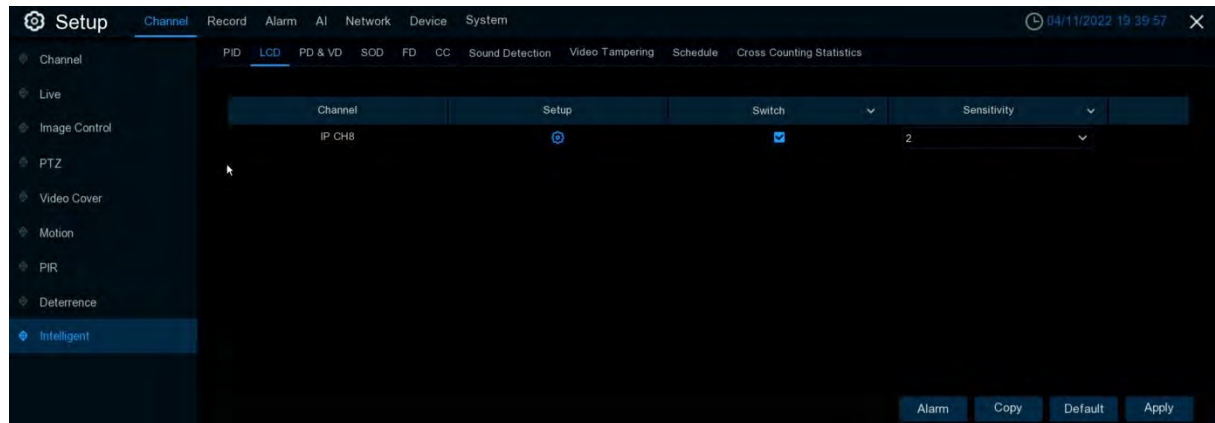

**Switch (Switch):** Turn on or disable this function

**Sensitive (sensitivity):** sensitivity, parameter range 1~4, default value 2, the higher the sensitivity of the detection target, the easier the moving target in the channel will be detected, and the more misdetection, the corresponding missing detection will be reduced, it is recommended to maintain the default value

**Area (Monitoring area):** Click **Setup**  to row the virtual area in the image

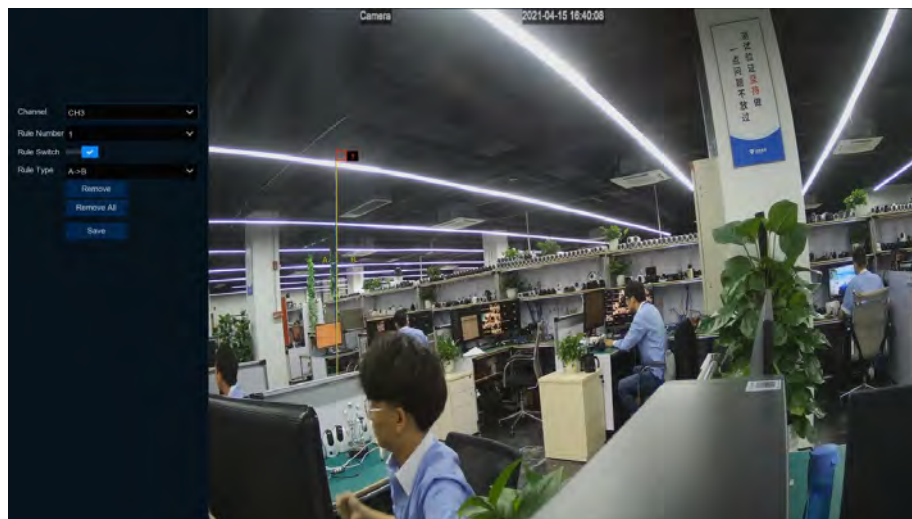

1. **Channel:** Channel: Select the channel that you want to configure
2. **Rule Number:** You can set four rules, draw rule areas on the area map and point to the few rules, then you can draw rules on the area map. The Rule Switch (rule switch) and Rule Type (rule type) of each rule are independent, and need to be turned on, off or set separately
3. **Rule Switch:** Enable detection in the rule switch
4. **Rule Type:** elect the rule type
  - A B: DVR only detects movements from side A to side B;
  - B A: The DVR only detects the actions from side B to side A;
  - A B: DVR will detect the action from plane B to plane A or from plane A to plane B;
5. Click on 2 points in the camera image to draw a virtual line.
6. Click on **Save** to save the settings
7. If you want to change the position or length of a line, click the red box in the line, and the color of the line becomes red. Long press the left mouse button to move the line, or drag the end of the line segment to modify the length or position of the line.



8. If you want to delete a line from the camera picture, click the red box in the line, and then click the Remove (**Remove**) button. Clicking Remove All (**Remove All**) will remove all lines.

**Notice:**

- 1) Lines should not be too close to the edge of the camera image, so as not to trigger an alarm when the target passes through the camera.
- 2) The line should not be set too short to avoid not triggering the alarm when the target crosses the alarm.

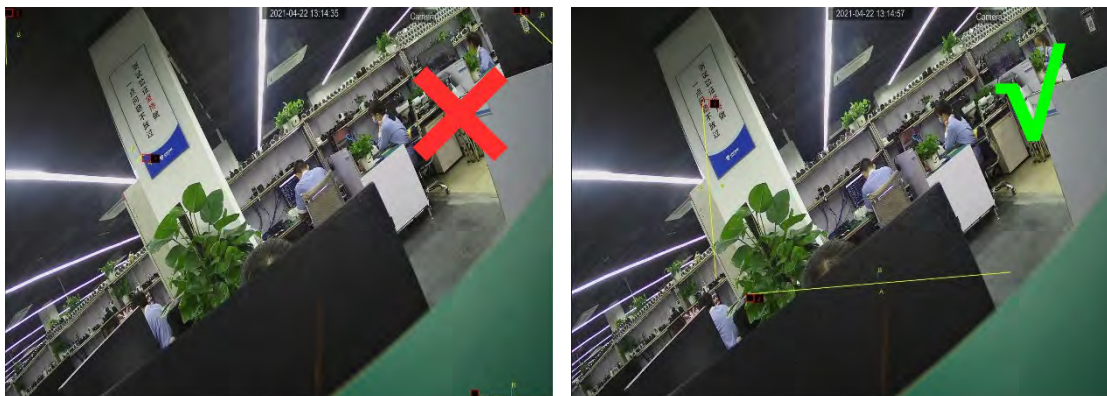

Click the Alarm button to configure the [5.3.4.2LCD \(Off-line detection alarm\)](#)

(**Note:** When LCD is triggered (cross-line detection), "S" will appear on the preview interface. In addition, LCD and PID / SOD are not mutually exclusive, but can be opened at the same time, mutually exclusive with PD / FD / CC, not at the same time)

**5.1.9.3 SOD (Stationary Object Detection)**

Stationary Object Detection function detects the objects left over or lost in the pre-defined region such as the baggage, purse, dangerous materials, etc., and a series of actions can be taken when the alarm is triggered.

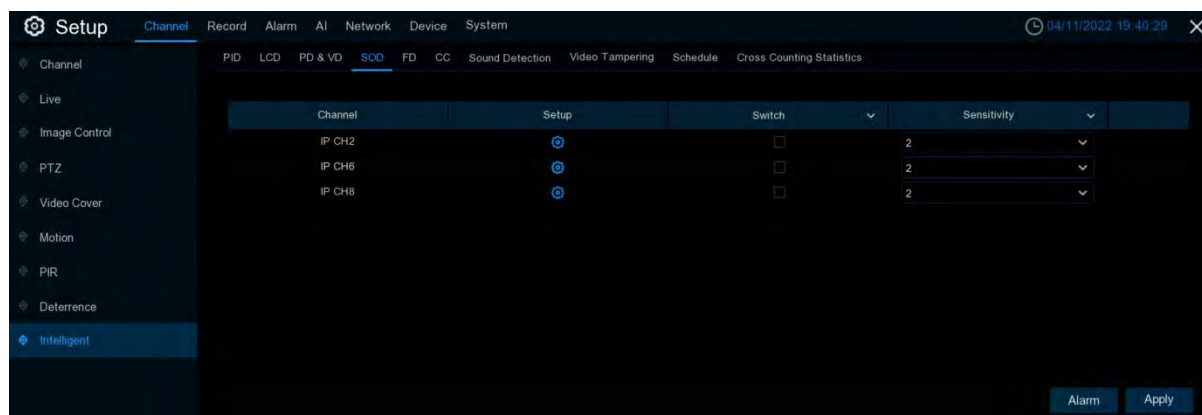

**Switch:** Turn on or disable this function

**Sensitive:** sensitivity, parameter range 1~4, default value 2, the higher the sensitivity of the detection target, the easier the moving target in the channel will be detected, and the more misdetection, the corresponding missing detection will be reduced, it is recommended to maintain the default value

**Area:** Click **Setup** to row the virtual area in the image

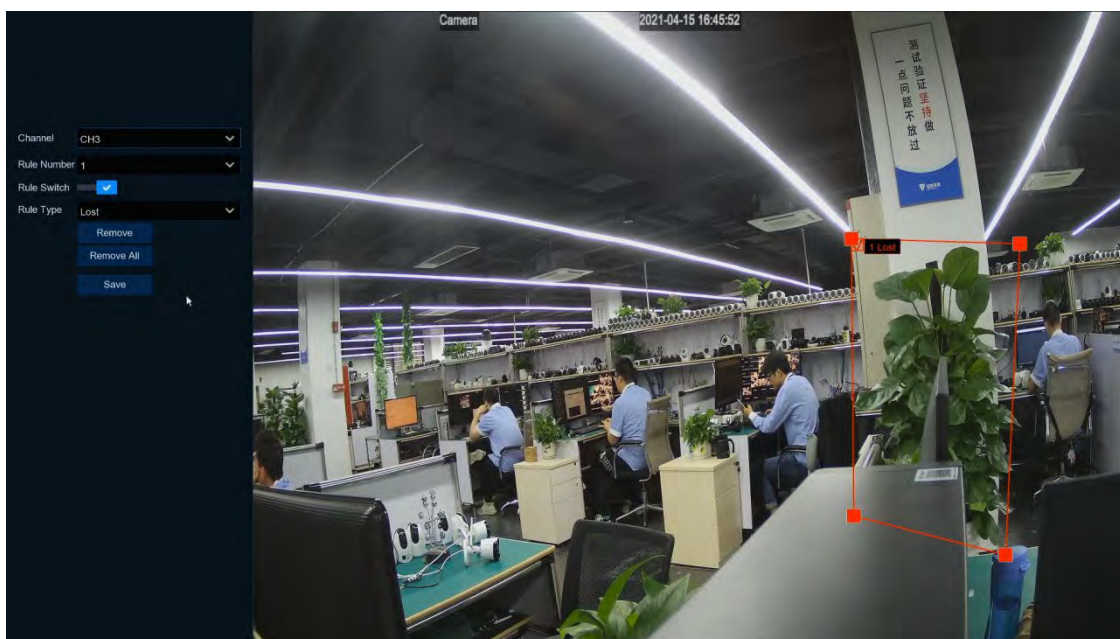

1. **Channel:** Select the channel that you want to configure
2. **Rule Number:** You can set four rules, draw rule areas on the area map and point to the few rules, then you can draw rules on the area map. The Rule Switch (rule switch) and Rule Type (rule type) of each rule are independent, and need to be turned on, off or set separately
3. **Rule Switch:** Enable detection in the rule switch.
4. **Rule Type:** Select the rule type.  
Legacy: DVR only detects legacy items;  
Lost : DVR will only detect lost items;  
Lost & Legacy left and lost: The DVR will detect left and lost items.
5. Click on 4 points in the camera image to draw a virtual area. The region shall be of a convex polygon. The concave polygons will not be saved.
6. Click on Save to save your settings.
7. If you want to resize the area, click **the red box** in the area, and the border of the area turns red. Press the left mouse button to move the entire area, or drag the corner to resize the area.
8. If you want to remove an area from the camera picture, click the red box in the area, and then click the Remove (Remove) button. Clicking Remove All (**Remove All**) will remove all areas.

#### CAUTION:

- 1) The detection area shall be greater than or equal to the size of the detected object, such as the detection of a blue bottle.
- 2) The detected objects cannot be blocked.



Click the **Alarm** button to configure the still life detection alarm function for details: [5.3.4.3 SOD \(Still life object alarm\)](#)

(Note: trigger SOD (still life detection), "S" will appear on the preview interface, SOD and PID / LCD are not mutually exclusive, can be opened at the same time, and PD / FD / CC, not open at the same time)

### 5.1.9.4 PD&VD (pedestrian and vehicle type detection)

The pedestrian detection function detects moving personnel in a predetermined area and takes a series of measures when an alarm is triggered.

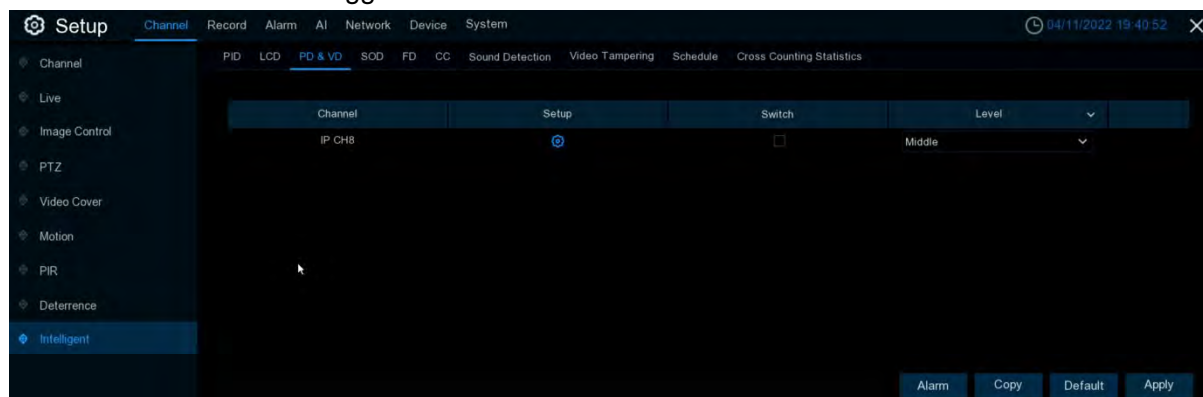

**Switch:** Turn on or disable this function

**Level:** The sensitivity level is low, medium to high. Higher sensitivity will be easier to trigger detection.

**Area:** Click **Setup**  to row the virtual area in the image

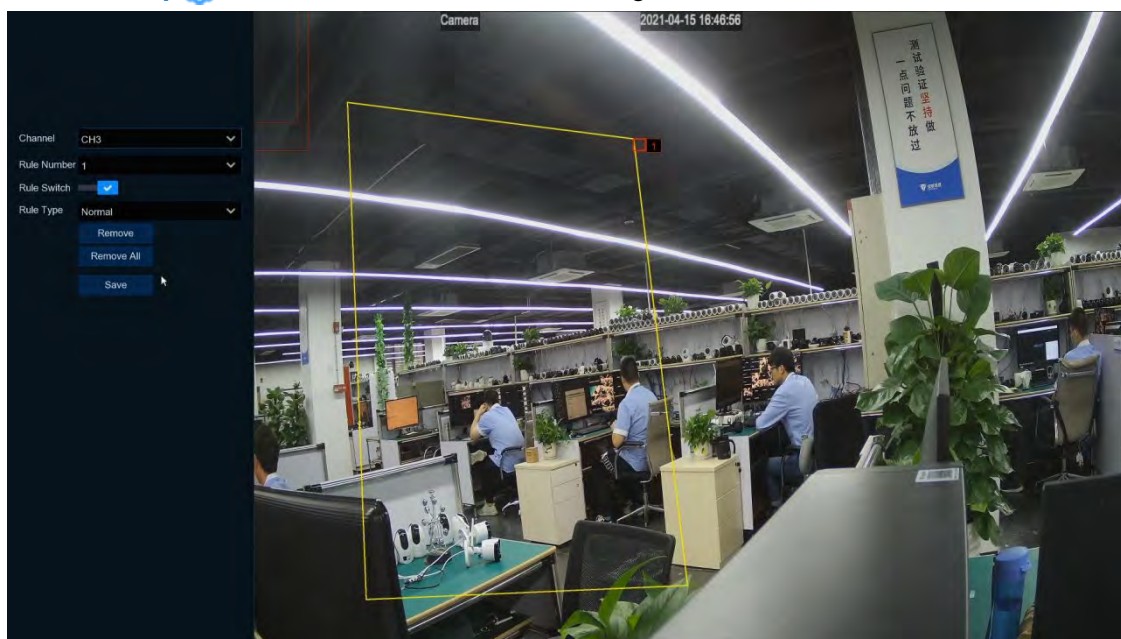

1. **Channel:** Select the channel that you want to configure
2. **Rule Number:** 2. Select the rule number. It is the number of PD regions. The PD function can set only 1 area.
3. **Rule Switch:** Enable detection in the rule switch.
4. **Rule Type:** Select Rule Type, Normal only normal
5. Click on 4 points in the camera image to draw a virtual area. The sharpness of the region should be a convex polygon. The concave polygons will not be saved.
6. Click on Save to save the settings.
7. If you want to resize the area, click the red box in the area, and the border of the area turns red. Press the left mouse button to move the entire area, or drag the corner to resize the area.
8. If you want to remove an area from the camera picture, click the red box in the area, and then click the Remove (**Remove**) button. Clicking Remove All (**Remove All**) will remove all areas.



**CAUTION:**

- 1) The test area shall not be located in the human-inaccessible areas.
- 2) The person found should be completely surrounded by the area.

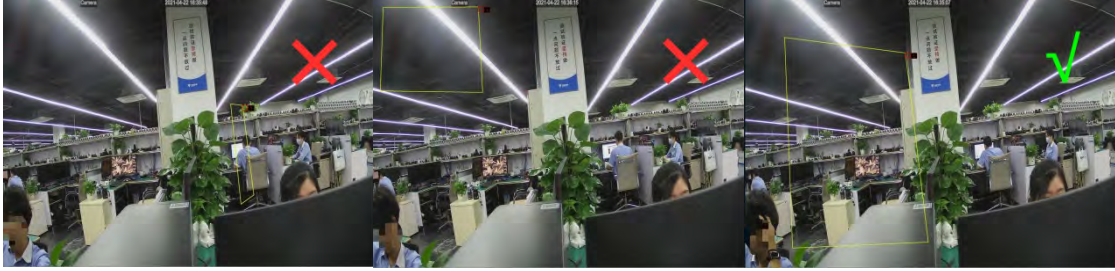

Click the **"Alarm"** button to configure the pedestrian detection alarm function, for details, please see [5.3.4.4 PD&VD \(pedestrian and vehicle detection alarm\)](#)

(Note: trigger PD & VD (pedestrian and vehicle detection), "S" will appear on the preview interface, PD & VD and FD / CC, can be opened at the same time, and PID / LCD / SOD, not at the same time)

**5.1.9.5 FD (face detection)**

Face Detection function detects the faces of moving people appear in a pre-defined region, and a series of actions can be taken when the alarm is triggered.

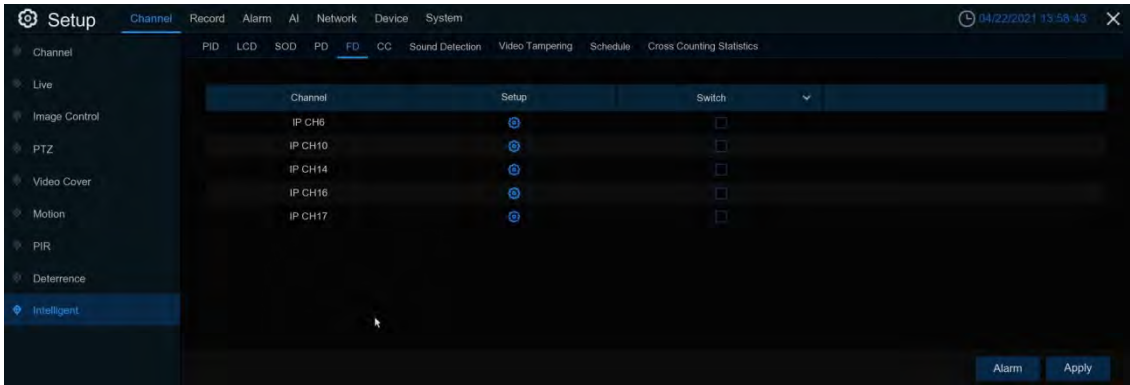

**Switch:** Turn on or disable this function

**Sensitive:** sensitivity, parameter range 1~4, default value 2, the higher the sensitivity of the detection target, the easier the moving target in the channel will be detected, and the more misdetection, the corresponding missing detection will be reduced, it is recommended to maintain the default value

**Area (Monitoring area) :** Click **Setup** to row the virtual area in the image



1. **Channel:** Select the channel that you want to configure
2. **Rule Number:** Select the rule number. It is the number of PD regions. The PD function can set only 1 area.
3. **Rule Switch:** Enable detection in the rule switch.
4. **Rule Type:** Select Rule Type, Normal is only optional.
5. Click on 4 points in the camera image to draw a virtual area. The sharpness of the region should be a convex polygon. The concave polygons will not be saved.
6. Click on **Save** to save the parameters.
7. If you want to resize the area, click the **red box** in the area, and the border of the area turns red. Press the left mouse button to move the entire area, or drag the corner to resize the area.
8. If you want to remove an area from the camera picture, click the red box in the area, and then click the Remove (Remove) button. Clicking **Remove All (Remove All)** will remove all areas.

**CAUTION:**

- 1) The test area shall not be located in the human-inaccessible areas.
- 2) The area should hold a full positive face.

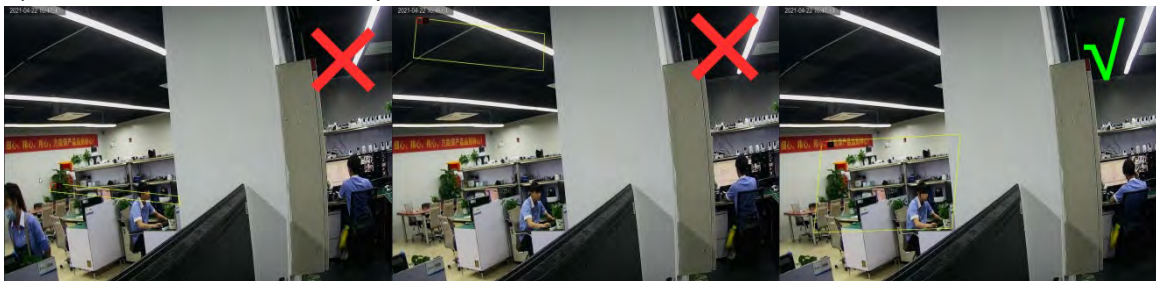

Click the Alarm button to configure the face detection alert function [5.3.4.5 FD \(face detection alarm\)](#)

(Note: When FD (pedestrian face detection) is triggered, "S" will appear on the preview interface. In addition, FD and PD / CC are not mutually exclusive, but can be opened at the same time, mutually exclusive with PID / LCD / SOD, not at the same time)

**5.1.9.6 CC (Cross-Counting)**

Cross-Counting function counts the times for moving objects or people across the virtual lines.

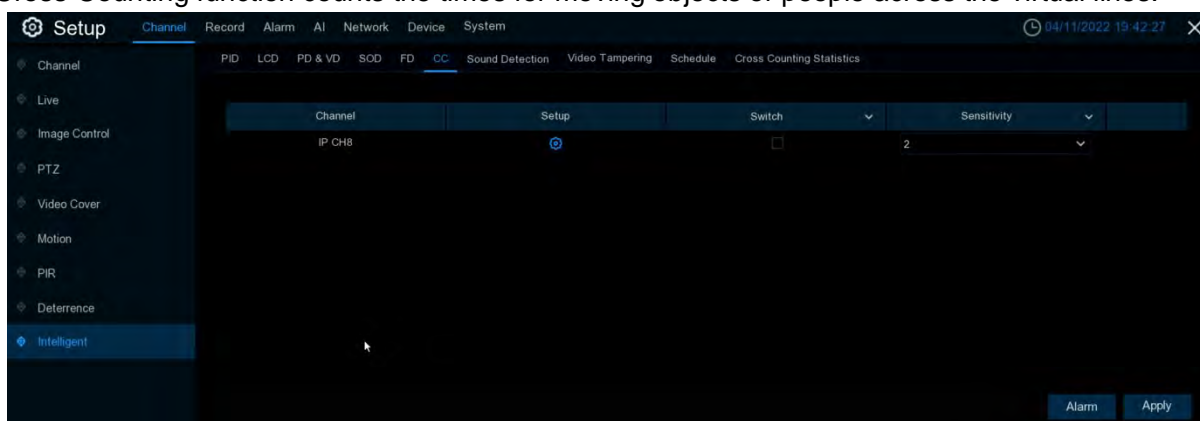

**Sensitive:** Sensitivity, parameter range 1~4, default value 2, the higher the sensitivity of the detection target, the easier the moving target in the channel will be detected, and the more misdetection will be detected, the corresponding missing detection will be reduced, it is recommended to maintain the default value

**Switch:** Turn the CC function on or off

**Area:** Click **Setup** to set the virtual lines in the camera image



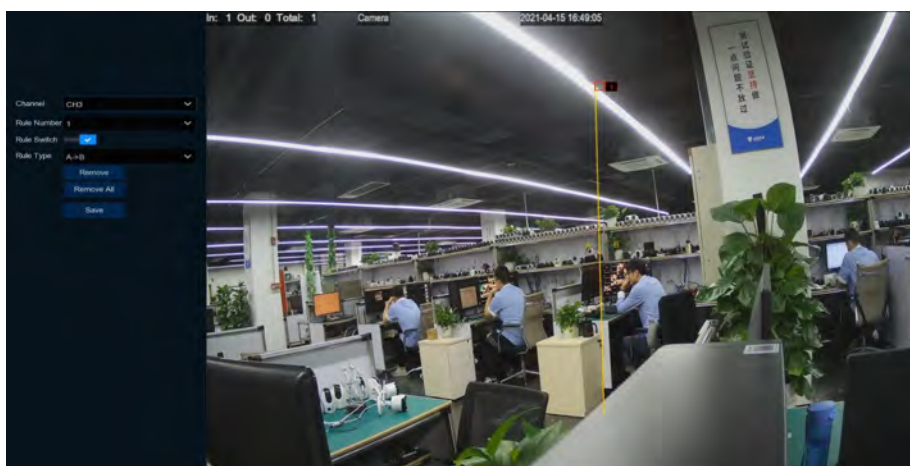

1. **Channel:** Select the channel that you want to configure.
2. **Rule Number:** Select the rule number. It is the number of virtual lines that you can draw. Up to 1 line.
3. **Rule Switch:** Enables detection rules in the rule switch.
4. **Rule Type:** Select the rule type
5. **Start Time:** Set the count start time.
6. **End Time:** Set the count end time.
7. **Reset Count:** Zero the count and reccount.
8. **Rule Number:** Rule serial number, with only one set of rules
9. **Rule Type:** Rule type  
 A-> B, DVR will count people or items from side A to side B.  
 B-> A, DVR will count people or items from side B to side A.
10. Click on Save to save your settings.
11. If you want to change the location or range of the rule, click the red box in the line, and the color of the line turns red. Long press the left mouse button to move the line, or drag the endpoint to modify the length or position of the line.

12. If you want to remove a line from the camera picture, click the red box in the line, and then click the Remove (Remove) button. Clicking Remove All (Remove All) will remove all lines.

#### CAUTION:

- 1) The regular line should not be too close to the edge of the camera image to trigger an alarm when the target crosses the line.
- 2) The rule line shall be located in the area accessible to the detected object.
- 3) The rule line should not be set too short to avoid an alarm when the target crosses the alarm.

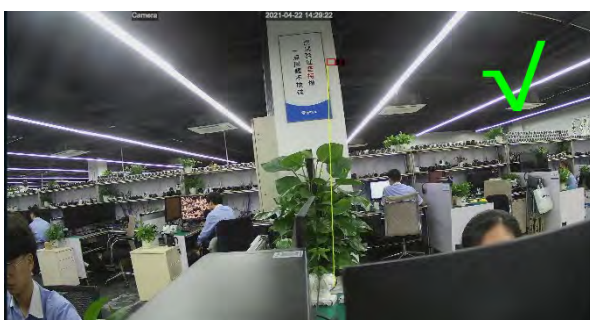
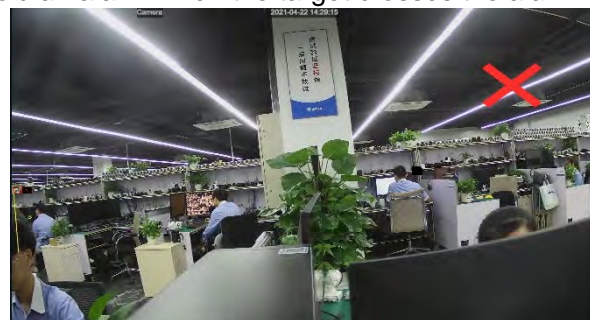
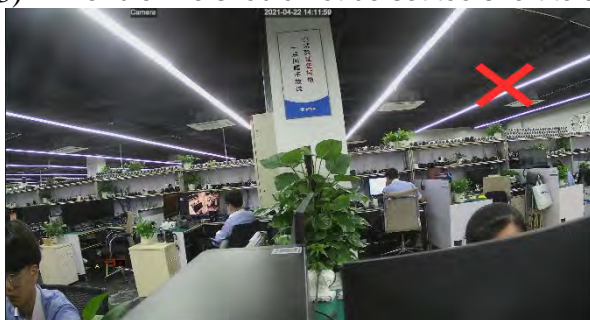

Click the Alarm button to configure the face detection alarm function for details:[5.3.4.6 CC \(line statistical alarm\)](#)

You can search for and view the statistical results of the overline counts in the[5.1.9.10 Cross Counting Statistics \(line statistical alarm\)](#) Statistics (Overline statistics)

(Note: When CC (crossing statistics) is triggered, "S" will appear on the preview interface, in addition, CC and PD / FD are not mutually exclusive, can be opened at the same time, and PID / LCD / SOD, not at the same time)

### 5.1.9.7 Sound Detection

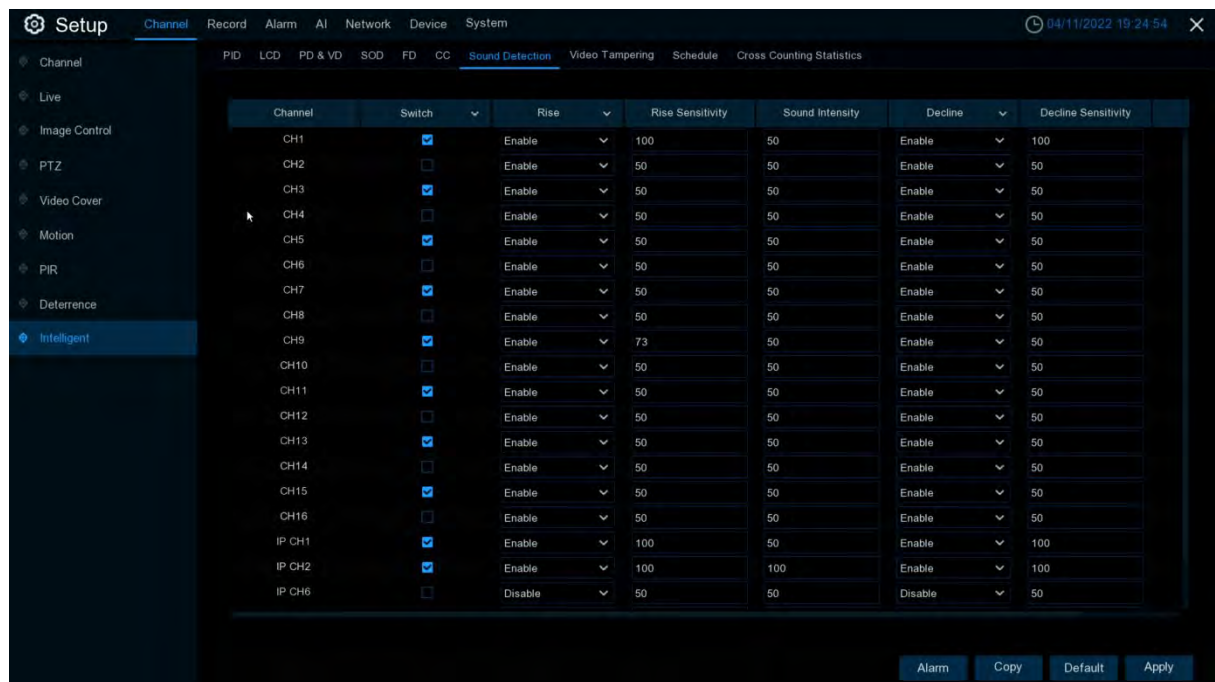

Through sound detection, the rise or fall of the sound can be detected to trigger the alarm, and take certain action when the alarm is triggered.

**Enable (switch):** Turn the sound detection on or off.

**Rise (Sound goes up):** Go on or off.

**Rise Sensitive (sound rise sensitivity):** trigger the sound rise sensitivity, sensitivity can be set to 1-100, the larger the value, the higher the sensitivity of the sound rise.

**Sound Intensity (sound intensity):** Set the trigger sound alarm intensity, which can be set to 1-100.

**Decline (sound drop):** See the sound on or sound off.

**Decline Sensitive (sound drop sensitivity):** trigger the sound drop sensitivity, sensitivity can be set to 1-100, the larger the value, the higher the sensitivity of the sound drop.

**Schedule (time schedule):** Set the time schedule for Sound Detection (sound detection), which is fully open by default, and the user can customize the time period to touch the sound alarm.

Click the AI arm button to configure the sound alert function for[5.3.4.7 Sound Detection \(acoustic alarm\)](#)

5.1.9.8 Video Tampering (Video Tampering)

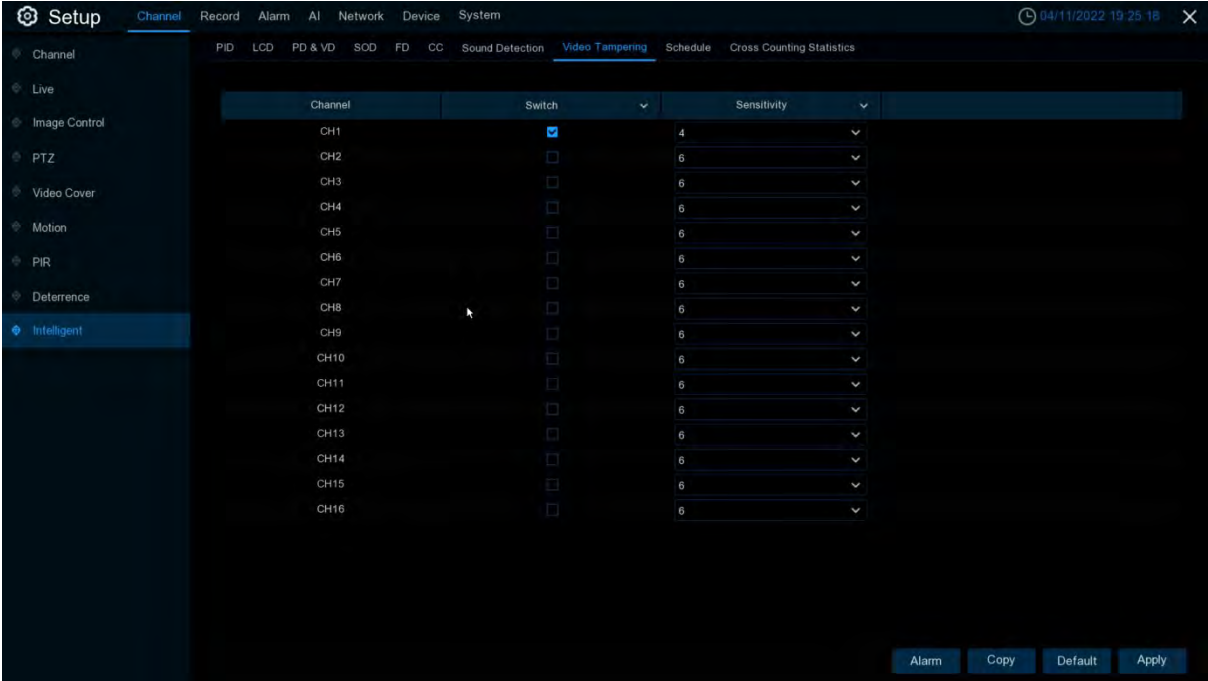

Video Tampering detection detects real-time view screen occlusion, and certain specific actions can be taken when an alarm is triggered.

**Switch:** Enable or disable the alarm caused by video cover.

**Sensitivity (sensitivity):** the sensitivity level is 1~6, the default value is 4. The higher the sensitivity, the easier it is to trigger the alarm.

Click the AI arm button to configure the video occlusion alarm function for details at [5.3.4.8 Video Tampering \(video occlusion alarm\)](#)

5.1.9.9 Schedule (Smart Schedule)

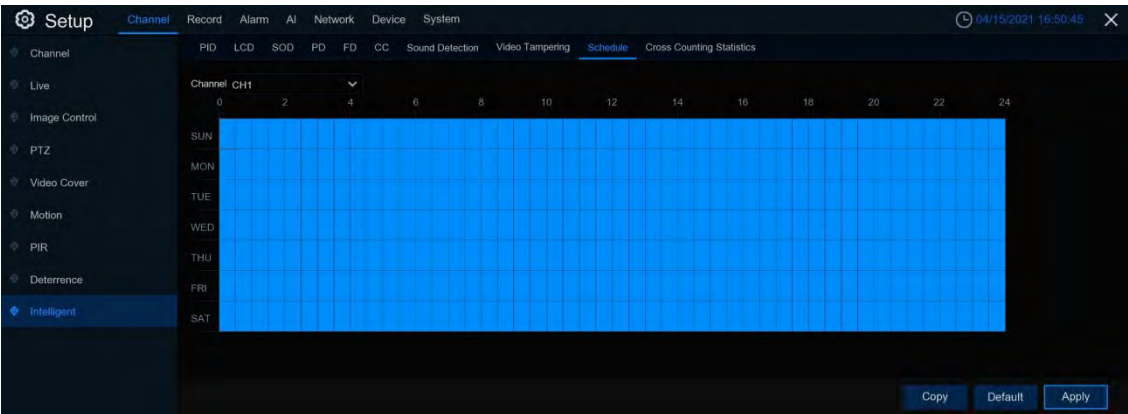

To activate the Intelligent Analytics feature, you will need to configure the schedule. The schedule will come into effect within 24 hours x 7 days.

To set a schedule, select a channel and drag the cursor marker area where a space in the table equals 30 minutes. Active intelligent detection in the region will be shown in sky-blue blocks. Each time you set it, the schedule is only valid for the selected channel. If you want to use the same schedule for other channels, use the replication feature. Click Save to save your settings.



5.1.9.10 Cross Counting Statistics (crossing statistics)

In the line statistics, the number of entry and exit of a period of time can be counted, and reflected in the way of statistical chart.

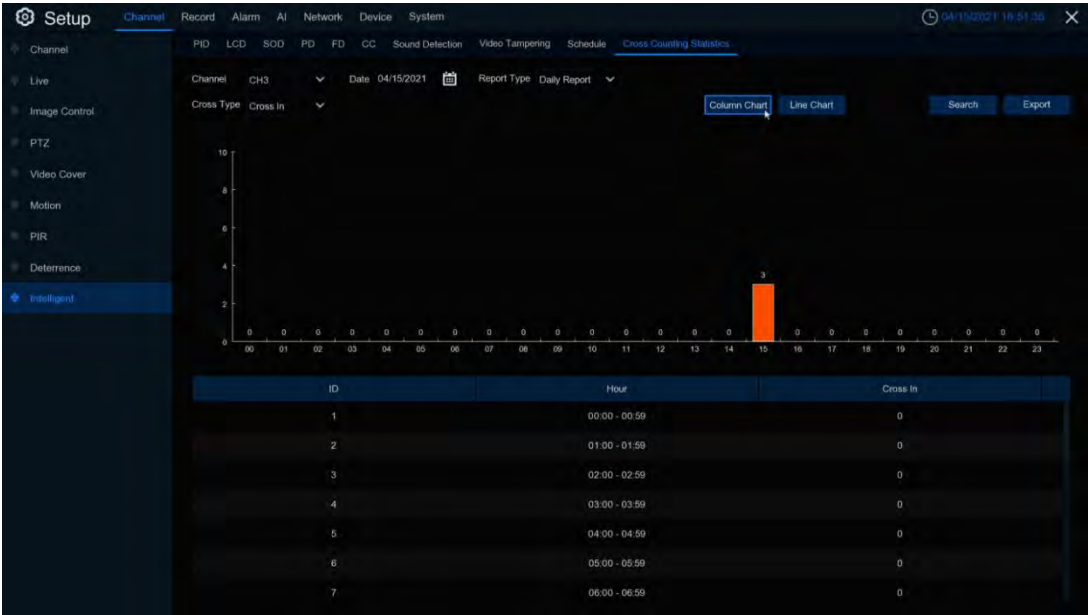

**Channel:** Select the channel that you want to search for

**Date:** Select the date that you want to search for

**Report Type:** Select the report type, with Daily Report, Weekly Report, Monthly Report, and Annual Report Type of report in

**Cross Type:** Crossing type, there are two types of Crosses in and Cross Out

Click on the Search to search for the data

**Export:** Results to export an external USB disk

Select **Column Chart** is shown as shown above

Select **Line Chart** shows the figure shown below

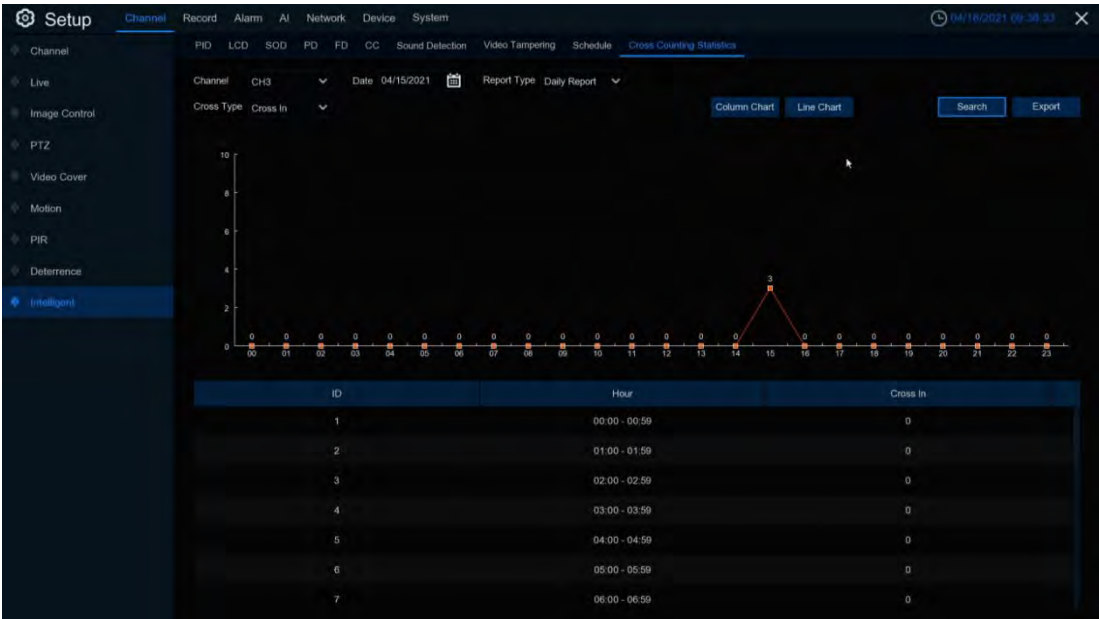

## 5.2 Recording

This menu allows you to configure the video recording parameters

### 5.2.1 Encoding

This menu allows you to configure the image quality for recorded video or network transfers. Generally, the master stream is the quality of the recorded video that will be saved in the HDD; the substream is the preview video quality through remote access (such as the Web client and CMS). Mobile code stream defines the preview quality of viewing remotely using mobile devices, and the switch of the connected IP camera's audio, the input and output volume, and the audio type can be set at the Audio interface.

#### 5.2.1.1 Mainstream

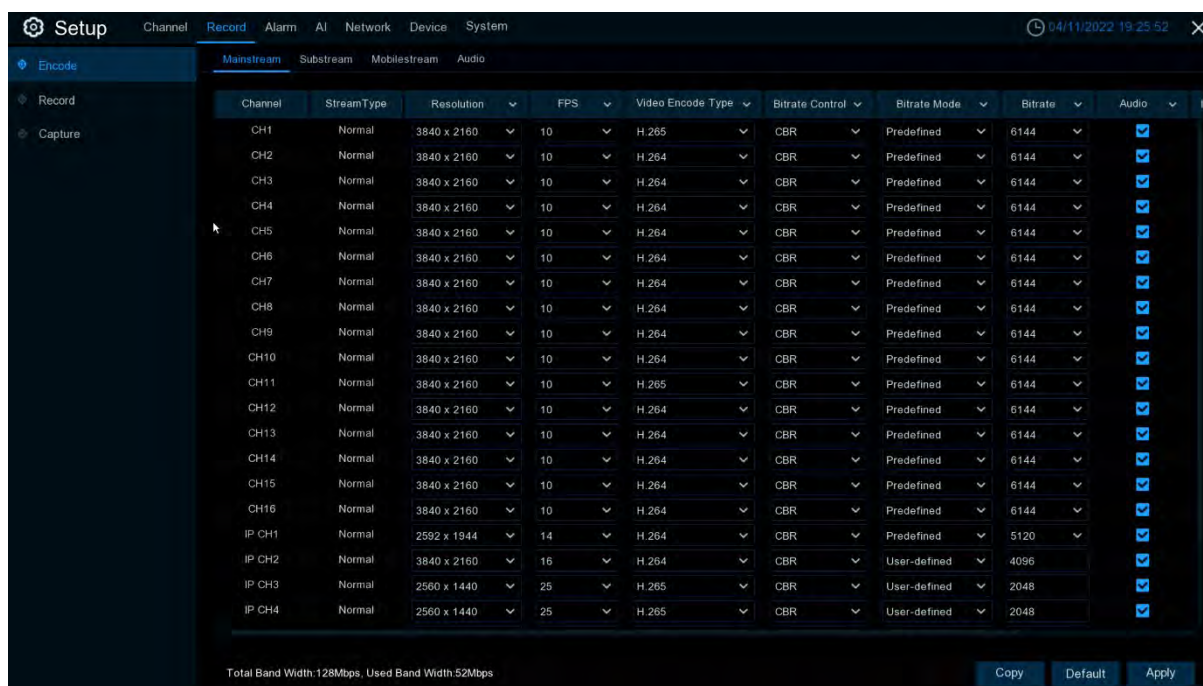
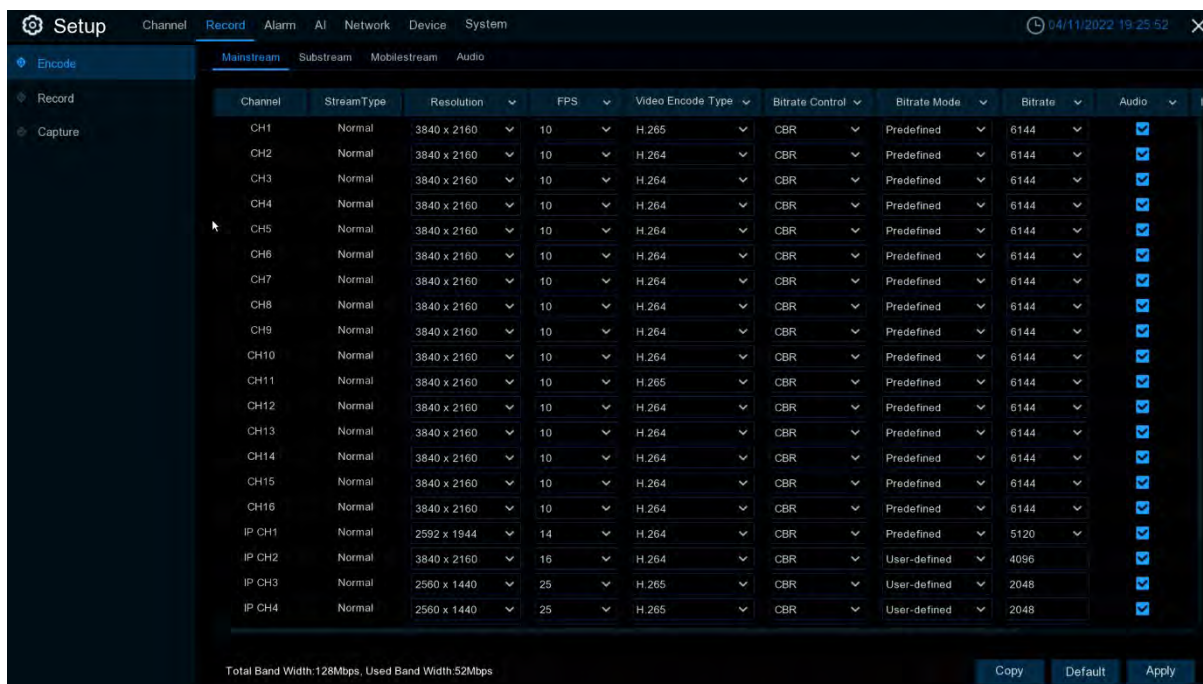

**Resolution:** This parameter represents the resolution of the recorded image.

**FPS:** This parameter represents the number of frames recorded by the DVR.

**Video Encode Type:** Channel decoding type, with 264, 265, 264 +, 265 +, and MJPEG.





**Resolution:** This parameter represents the resolution of the recorded image.

**FPS:** This parameter represents the number of frames recorded by the DVR.

**Video Encode Type:** Channel decoding type, with 264,265,264 +, 265 +, and MJPEG.

**Bitrate Control:** Select the bit rate level. For simple scenarios, for example, a gray wall is suitable for using a constant bit rate (CBR). For more complex scenarios, such as busy streets, it is suitable for using a variable bit rate (VBR).

**Video Quality:** The optional values are Lowest, Lower, Low, Medium, Higher, and Highest

**Bitrate Mode:** If you want to set your own bit rate, select User Defined mode. If you want to select a preset bit rate, select Preset Mode.

**Bitrate:** This parameter corresponds to the data transmission speed that the DVR uses to record the video. Video recording with a higher bit rate will have a better quality.

**Audio:** If you want to record both audio and video, use an audio-enabled video camera.

**I Frame Interval (I frame interval):** Set the I frame interval for the camera.

### 5.2.1.3 Mobilestream

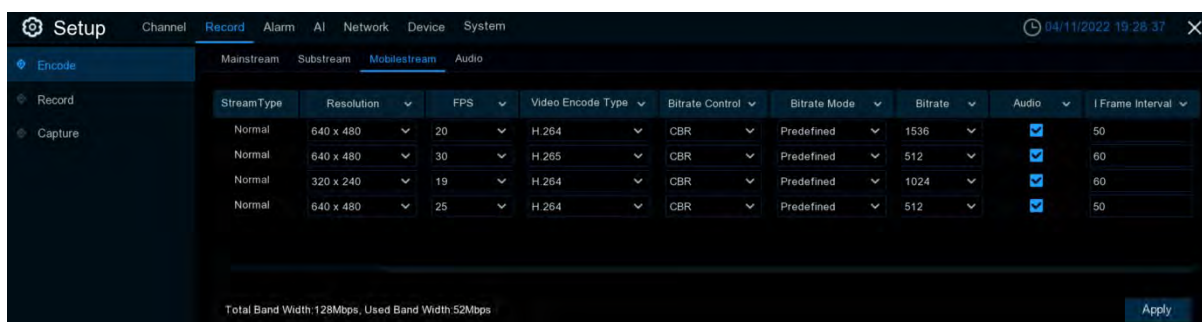

**Switch:** Turn the phone code stream on or off

**Resolution:** This parameter represents the resolution of the recorded image.

**FPS:** This parameter represents the number of frames recorded by the DVR.

**Video Encode Type:** Channel decoding type, with 264,265,264 +, 265 +.

**Bitrate Control:** Select the bit rate level. For simple scenarios, for example, a gray wall is suitable for using a constant bit rate (CBR). For more complex scenarios, such as busy streets, it is suitable for using a variable bit rate (VBR).

**Video Quality:** The optional values are Lowest, Lower, Low, Medium, Higher, and Highest

**Bitrate Mode:** If you want to set your own bit rate, select User Defined mode. If you want to select a preset bit rate, select Preset Mode.

**Bitrate:** This parameter corresponds to the data transmission speed that the DVR uses to record the video. Video recording with a higher bit rate will have a better quality.

**Audio:** If you want to record both audio and video, use an audio-enabled video camera.

**I frame Interval (I frame interval):** Set the I frame interval for the camera.

5.2.1.4 Audio

**Audio Menu tab:** Set up the audio of the camera (with device support).

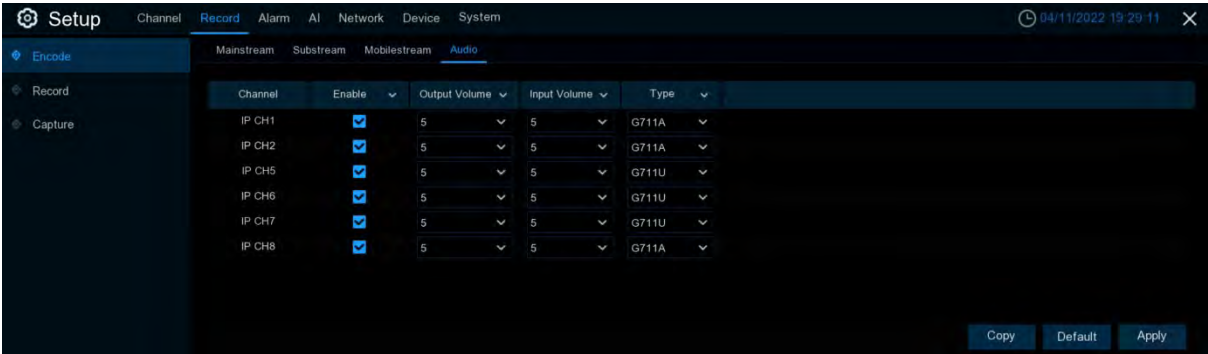

- Enable:** Set up the audio switch for the video camera.
- Output Volume:** Set the output volume of the camera.
- Input Volume:** Set the input volume of the video camera.
- Type:** Set the audio decoding type of the camera.

5.2.2 Video recording

This menu enables you to configure the recording parameters

5.2.2.1 Video recording Settings

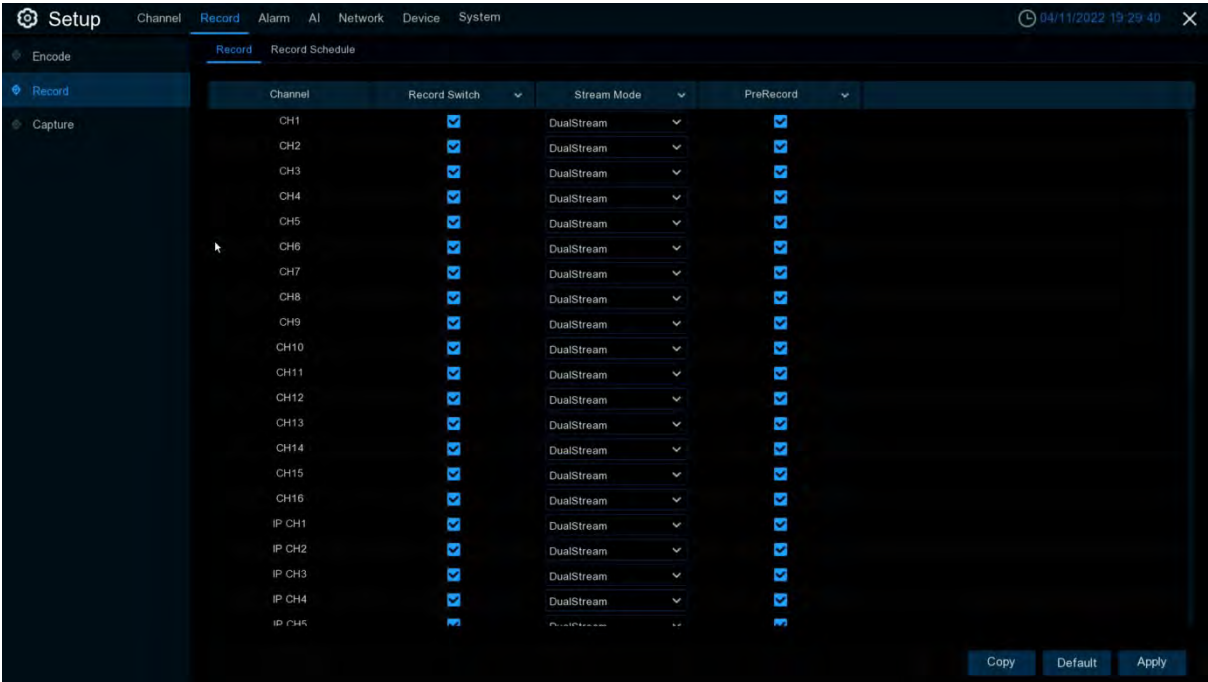

- Record Switch (Recording Switch):** Select to enable recording in this channel.
- Stream Mode (code stream mode):** Select the recording quality. If you select a dual code stream, both the primary and child code stream are recorded; if the primary code stream is selected, only the main code stream video is recorded.
- PreRecord (Pre-video):** If this option is enabled, the DVR starts recording a few seconds before an alert event occurs. This option is recommended if your primary video type is based on mobile detection or I / O alerts.



### 5.2.2.2 Video recording schedule

This menu allows you to specify when the DVR records the video and determine the recording mode for each channel. The recording schedule lets you set video schedules, such as daily (hourly) regular (continuous) recording, motion detection recording, I / O alert recording, and PIR recording (if DVR supports) time. To set the video mode, click the mode radio button (General, Motion Detection, IO, PIR), and then drag the cursor to mark the area. The recording schedule is valid for only one channel. If you want to use the same recording schedule for other channels, click Copy (Apply) to use the replication functionality. Click Apply (Apply) to save the settings.



**Channel (Channel):** Select a channel to set its video recording parameters.

**Normal (General):** When the area is marked green, the channel regularly videos the corresponding time.

**Motion (mobile detection):** When the area is marked yellow, the channel moves the area for the corresponding time.

**IO:** When the area is marked as red, it indicates that the channel IO alarms the corresponding time of the area.

**PIR:** When the area is marked as purple, the channel recorded the PIR alarm for the corresponding time of the area.

**No Record :** The time area marked in black indicates that the recording is not scheduled for that session.

### 5.2.3 Capture

This menu allows you to configure the scratch feature feature.

#### 5.2.3.1 Capture settings 1

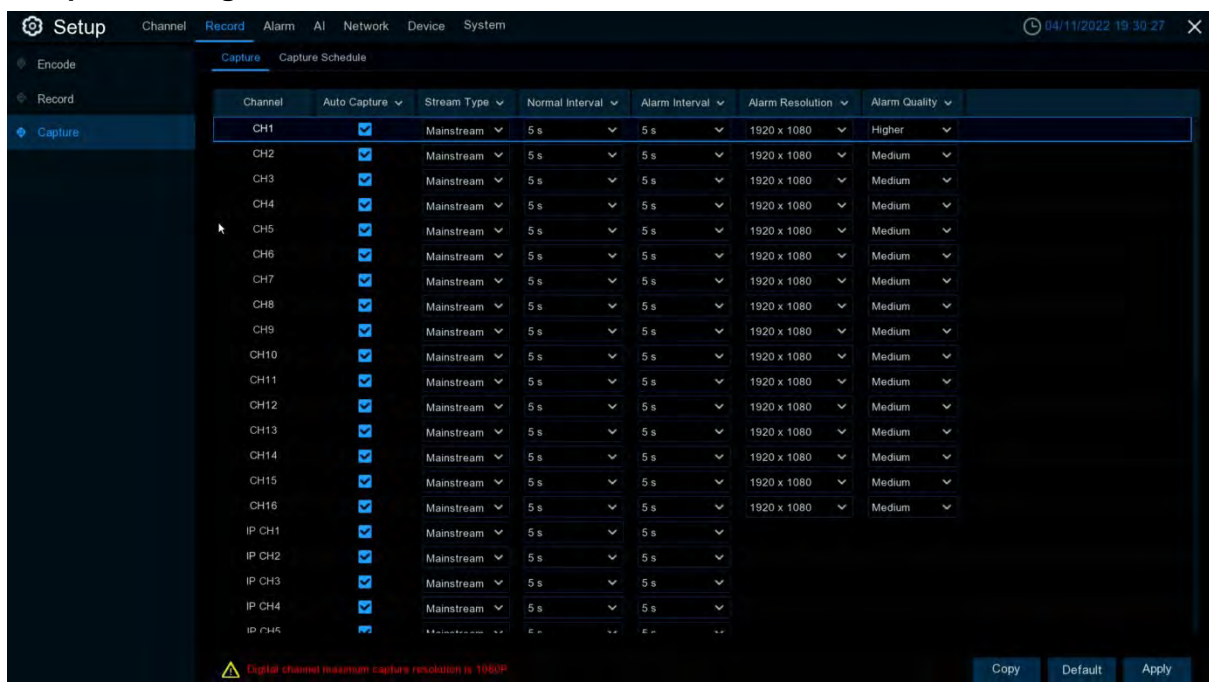

**Auto Capture (autoscratching):** Enables or disables autoscratching on the channel.

**Stream T ype (code stream type):** Select the image resolution for the primary or substream.

**Normal Interval (regular scratch interval):** scratch time interval in regular recording.

**Alarm Interval (Alarm capture interval):** capture time interval during triggering mobile detection, IO alarm or PIR.

### 5.2.3.2 Capture Schedule table 2

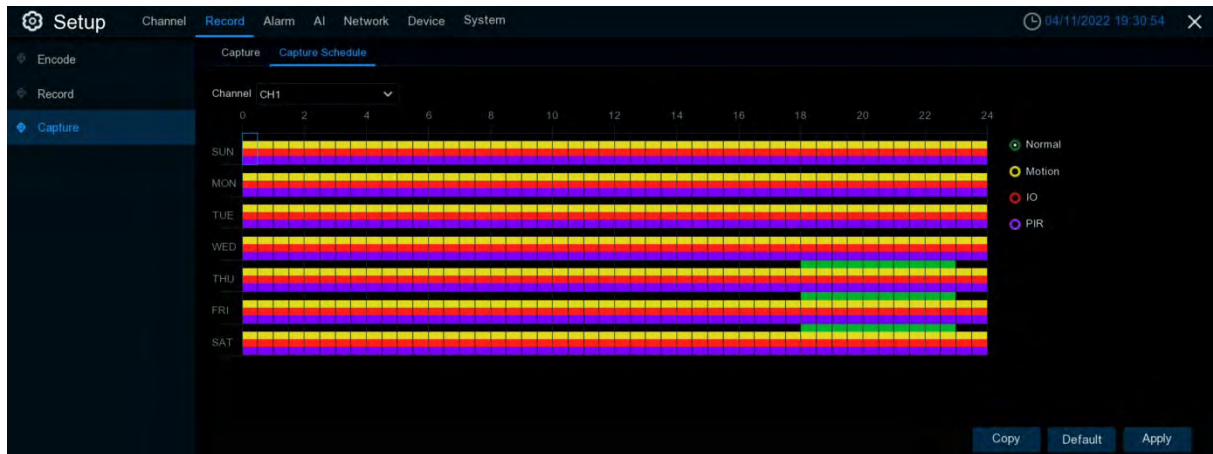

**Channel (Channel):** Select a channel to set its grip parameters.

**Normal (General):** When the area is marked green, the channel regularly grasps the corresponding time.

**Motion (Move detection):** When the area is marked yellow, the channel moves the area for the corresponding time.

**IO:** When the area is marked as red, it indicates that the channel IO alarms the corresponding time of the area.

**PIR:** When the area is marked in purple, the channel PIR alarms the area for the corresponding time.

**No Capture:** The time area marked black indicates that the grab is not scheduled.



### 5.3 Alarm

Configure the alarm parameters

#### 5.3.1 Mobile detection and alarm

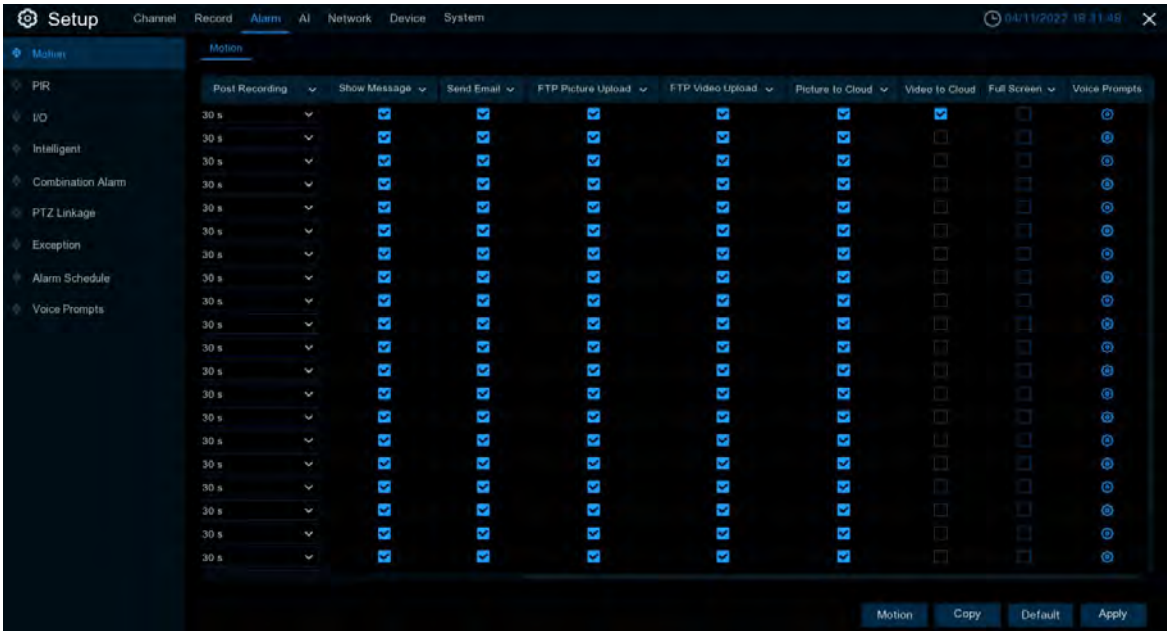
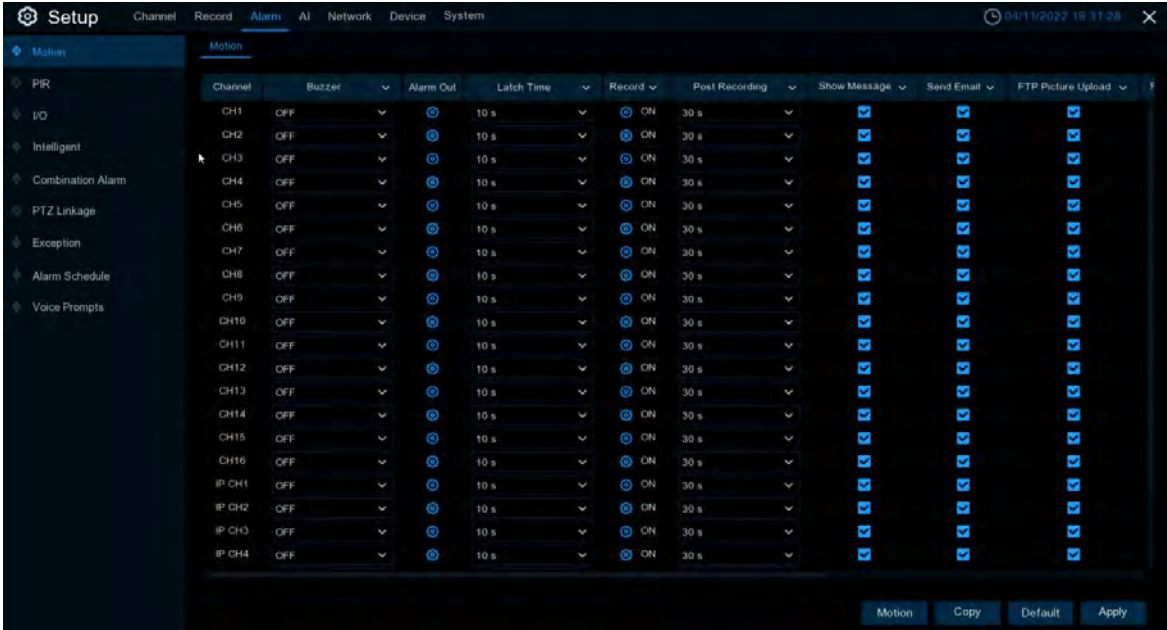

**Channel (Channel Name):** Channel name

**Buzzer (buzzer):** The DVR can use its internal buzzer to sound an alarm. You can set the buzzer duration in seconds when an action is detected.

**Alarm Out (Alarm output):** optional function. If your DVR supports a connection to an external alert device, you can set up an external alert device.

**Latch Time (Alarm trigger duration):** configure the external alarm trigger duration with motion detected (10s, 20s, 40s, and 1Min).

**Record (Recording):** Click  the icon to select the channel to record when triggering motion detection.



**Post Recording (delayed video recording):** You can set the duration of continuous DVR recording after the event occurs. The suggested recording time is 30 seconds, but can be set to up to 5 minutes.

**Show Message (Display icon):** Select this box to display the icon on the real-time display screen when motion is detected.

**Send Email (Send Mail):** You can let the DVR send you an automatic e-mail message when a movement is detected.

**FTP Picture Upload (FTP image upload):** After triggering the alert, upload the alert picture to the FTP server. See the [5.5.4 FTP](#) for more details

**FTP Video Upload (FTP video upload):** After the alarm is triggered, upload the alarm video to the FTP server. See the [5.5.4 FTP](#) for more details

**Picture to Cloud (Cloud Storage Picture):** After an alert, upload the alert picture to the cloud storage. See [5.6.2 Cloud Storage](#) for more details

**Video to Cloud (Cloud Storage Video):** After an alert is triggered, upload the alert video to the cloud storage. See [5.6.2 Cloud Storage](#) for more details

**Full Screen (Full-Screen Display):** If you have this feature enabled and detected motion in the channel, you will see the channel in full-screen mode.

**Voice Prompts:** Voice prompt, when the alarm is triggered, the audio file imported by voice prompt (IPC to support voice prompt function), details can be seen [5.3.9 voice broadcast](#)

### 5.3.2 PIR alarm

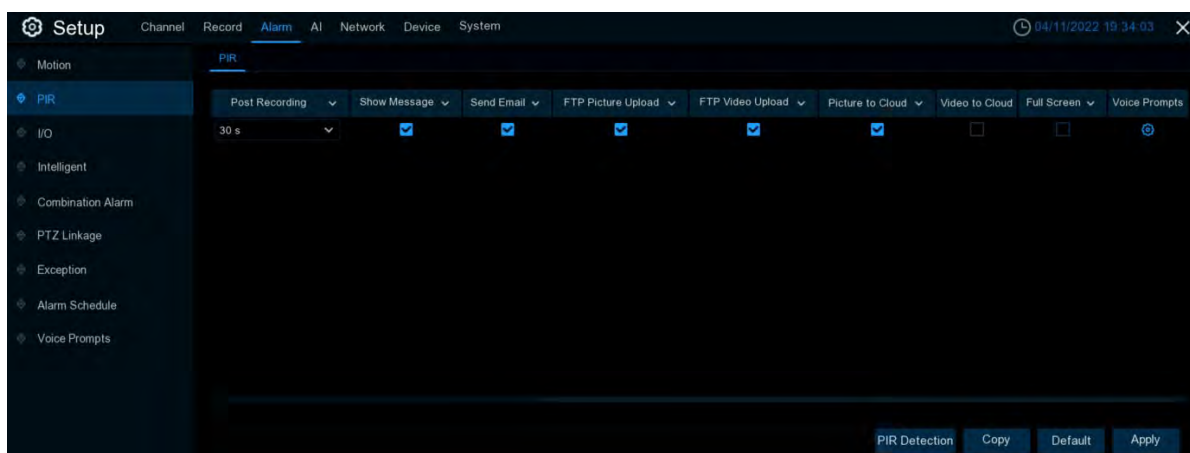
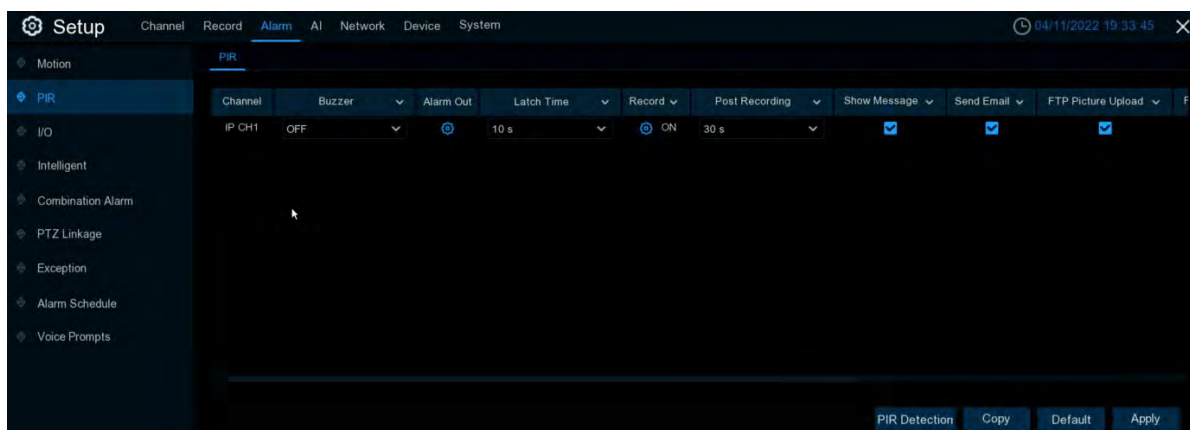

This menu enables you to configure the relevant parameters for the PIR alarm.

**Channel (Channel Name):** Channel name

**Buzzer (buzzer):** The DVR can use its internal buzzer to sound an alarm. You can set the buzzer duration in seconds when a PIR is detected.

**Alarm Out (Alarm output):** optional function. If your DVR supports a connection to an external alert device, you can set up an external alert device.

**Latch Time (Alarm trigger time):** configure external alarm trigger duration (10s, 20s, 40s and 1Min).

**Record (recording):** Click the icon  to select the channel to record when triggering the PIR



**Post Recording (delayed video recording):** You can set the duration of continuous DVR recording after the event occurs. The suggested recording time is 30 seconds, but can be set to up to 5 minutes.

**Show Message (Display icon):** Select this box to display the icon  on the real-time display screen when the PIR is detected.

**Send Email (Send Mail):** You can let DVR send you automatic e-mail when PIR is detected.

**FTP Picture Upload (FTP image upload):** After triggering the alert, upload the alert picture to the FTP server. See the [5.5.4 FTP](#) for more details

**FTP Video Upload (FTP video upload):** After the alarm is triggered, upload the alarm video to the FTP server. See the [5.5.4 FTP](#) for more details

**Picture to Cloud (Cloud Storage Picture):** After an alert, upload the alert picture to the cloud storage. See [5.6.2 Cloud Storage](#) for more details

**Video to Cloud (Cloud Storage Video):** After an alert is triggered, upload the alert video to the cloud storage. See [5.6.2 Cloud Storage](#) for more details

**Full Screen (Full-screen display):** If this feature is enabled and a PIR is detected in the channel, you will see the channel in full-screen mode.

**Voice Prompts:** Voice prompt, when the alarm is triggered, the audio file imported by voice prompt (IPC to support voice prompt function), details can be seen [5.3.9 voice broadcast](#)

### 5.3.3 I/O Alarm

This is an optional feature that appears if your DVR supports sensor I / O and you connect to an external sensor I / O alarm device to work with the DVR.

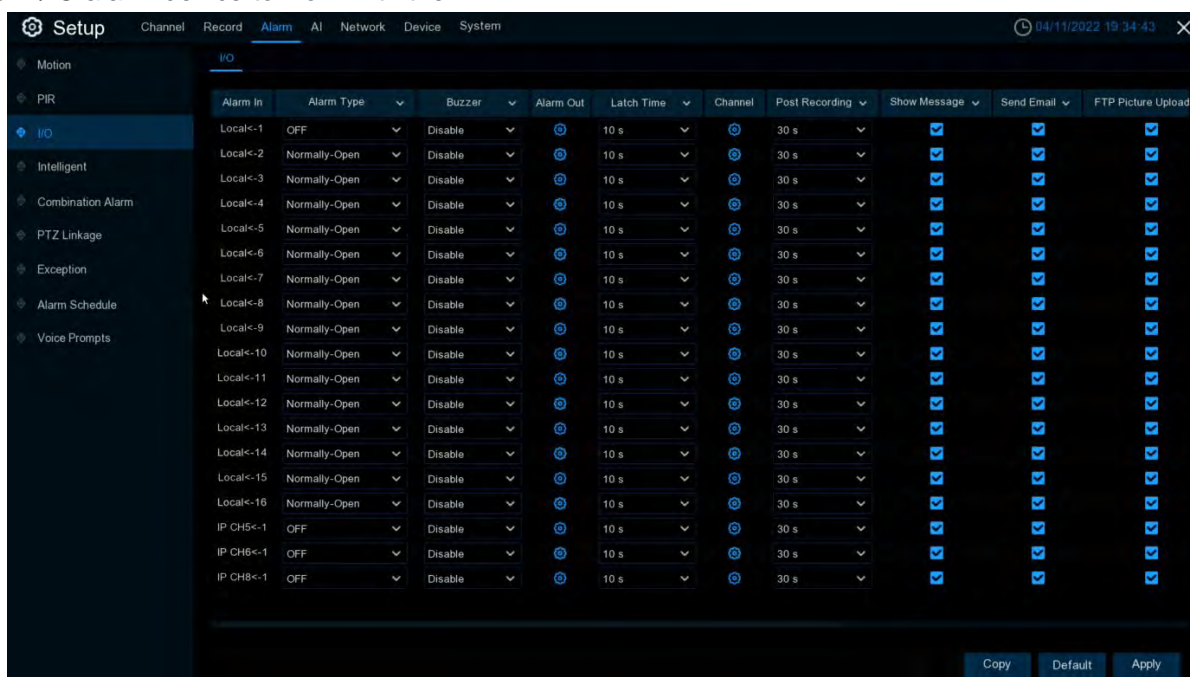



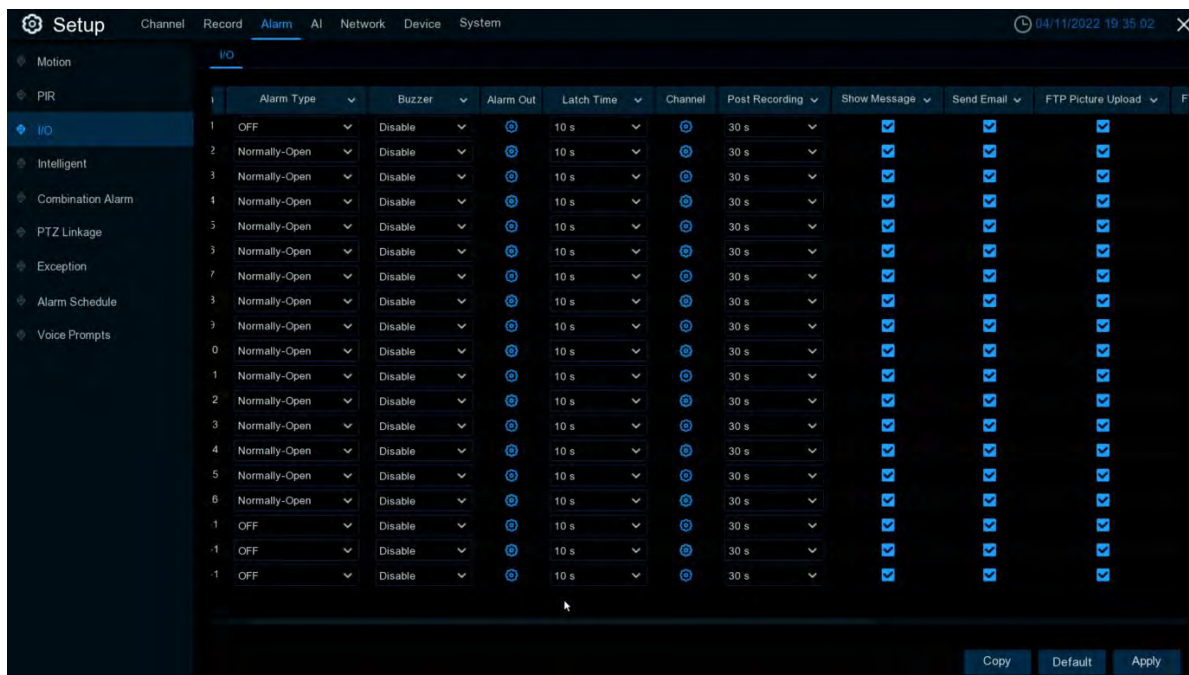

**Alarm In (Alarm input):** I / O alarm channel.

**Alarm Type (Alarm Type):** You can choose 3 types: open, close and close. Select a type that matches your sensor type, or select Close to turn off the sensor trigger function.

**Buzzer (buzzer):** The DVR can use its internal buzzer to sound an alarm. You can set the buzzer duration (in seconds) when triggering IO warnings.

**Alarm out (alarm output):** Check the external alarm device when the IO alarm is triggered.

**Latch Time (Alarm Trigger Time):** You can set the triggering of the external alarm device in time (10s, 20s, 40s, and 1Min).

**Record (Recording):** Click the icon  and select the channel to record when triggering the IO alarm.

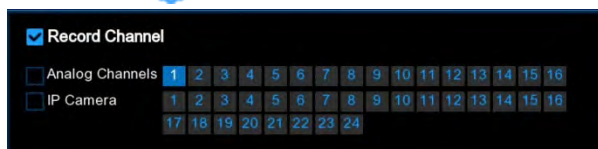

**Post Recording:** Click the icon Post Recording (delayed video recording): You can set the duration of continuous DVR recording after the event occurs. The suggested recording time is 30 seconds, but can be set to up to 5 minutes.

**Show Message (Display icon):** Select this box to display the icon on the real-time display screen when an I / O alarm is detected.

**Send Email (Send Mail):** You can let the DVR send you an automatic email when an I / O alarm is detected.

**FTP Picture Upload (FTP image upload):** After triggering the alert, upload the alert picture to the FTP server. See the [5.5.4 FTP](#) for more details

**FTP Video Upload (FTP video upload):** After the alarm is triggered, upload the alarm video to the FTP server. See the [5.5.4 FTP](#) for more details

**Picture to Cloud (Cloud Storage Picture):** After an alert, upload the alert picture to the cloud storage. See [5.6.2 Cloud Storage](#) for more details

**Video to Cloud (Cloud Storage Video):** After an alert is triggered, upload the alert video to the cloud storage. See [5.6.2 Cloud Storage](#) for more details

**Full Screen (Full-screen display):** If this feature is enabled and an I / O alarm is detected in the channel, you will see the channel in full-screen mode.

**Voice Prompts:** Voice prompt, when the alarm is triggered, the audio file imported by voice prompt (IPC to support voice prompt function), details can be seen [5.3.9 voice broadcast](#)

## 5.3.4 Intelligent analysis and alarm

### 5.3.4.1 PID (Perimeter intrusion Detection)

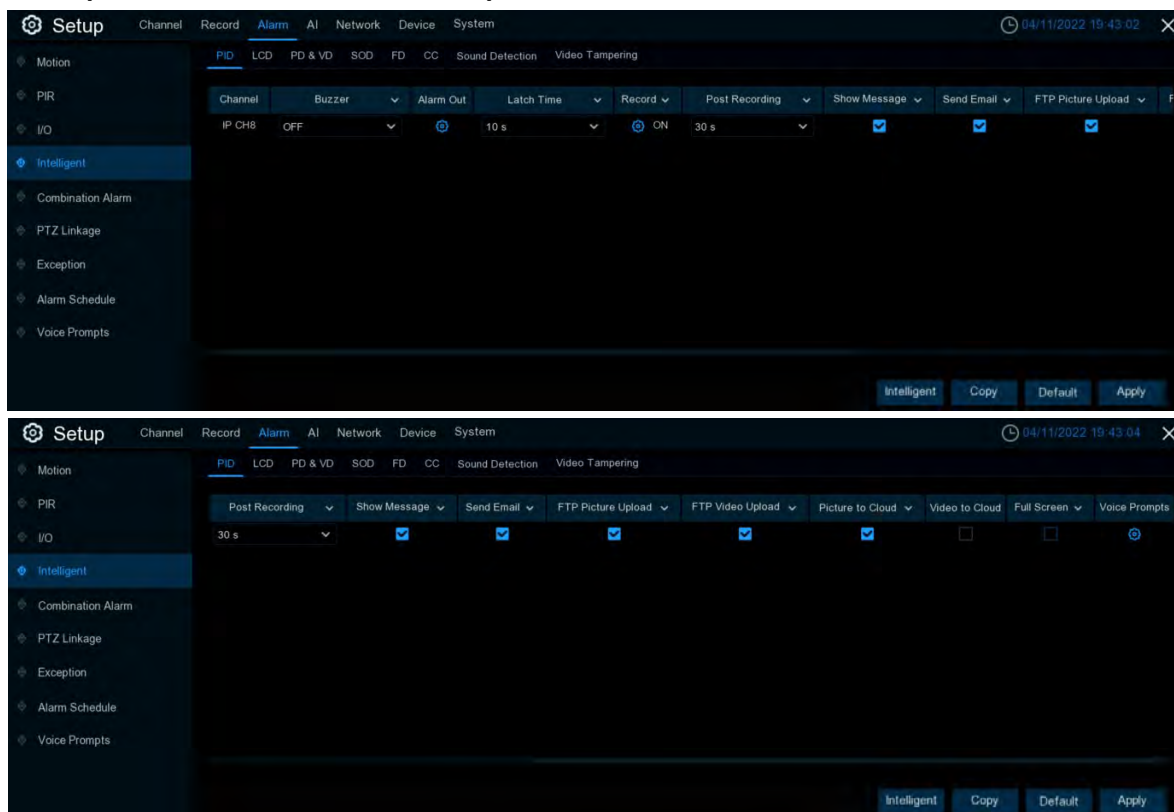

You can configure the PID alarm function here.

**Channel:** Channel name

**Buzzer (buzzer):** The DVR can use its internal buzzer to sound an alarm. You can set the buzzer duration (in seconds) when triggering a perimeter intrusion alarm.

**Alarm out (Alarm output):** Check the external alarm device when the perimeter intrusion alarm is triggered.

**Latch Time (Alarm Trigger Time):** You can set the triggering of the external alarm device in time (10s, 20s, 40s, and 1Min).

**Record (Recording):** Click the icon  and select the channel to record when triggering the perimeter intrusion alarm.

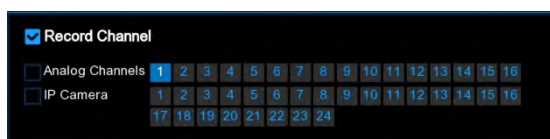

**Post Recording (delayed video recording):** You can set the duration of continuous DVR recording after the event occurs. The suggested recording time is 30 seconds, but can be set to up to 5 minutes.

**Show Message (Display icon):** Select this box to display the icon on the real-time display screen when a perimeter intrusion alarm is detected.

**Send Email (Send Mail):** You can let DVR send you automatic e-mail when perimeter intrusion alarms are detected.

**FTP Picture Upload (FTP image upload):** After triggering the alert, upload the alert picture to the FTP server. See the [5.5.4 FTP](#) for more details

**FTP Video Upload (FTP video upload):** After the alarm is triggered, upload the alarm video to the FTP server. See the [5.5.4 FTP](#) for more details

**Picture to Cloud (Cloud Storage Picture):** After an alert, upload the alert picture to the cloud storage. See [5.6.2 Cloud Storage](#) for more details

**Video to Cloud (Cloud Storage Video):** After an alert is triggered, upload the alert video to the cloud storage. See [5.6.2 Cloud Storage](#) for more details

**Full Screen (Full-screen Display):** If this feature is enabled and a perimeter intrusion alarm is detected in the channel, you will see the channel in full-screen mode.

**Voice Prompts:** Voice prompt, when the alarm is triggered, the audio file imported by voice prompt (IPC to support voice prompt function), details can be seen [5.3.9 voice broadcast](#)



## 5.3.4.2 LCD (Line Cross detection and alarm)

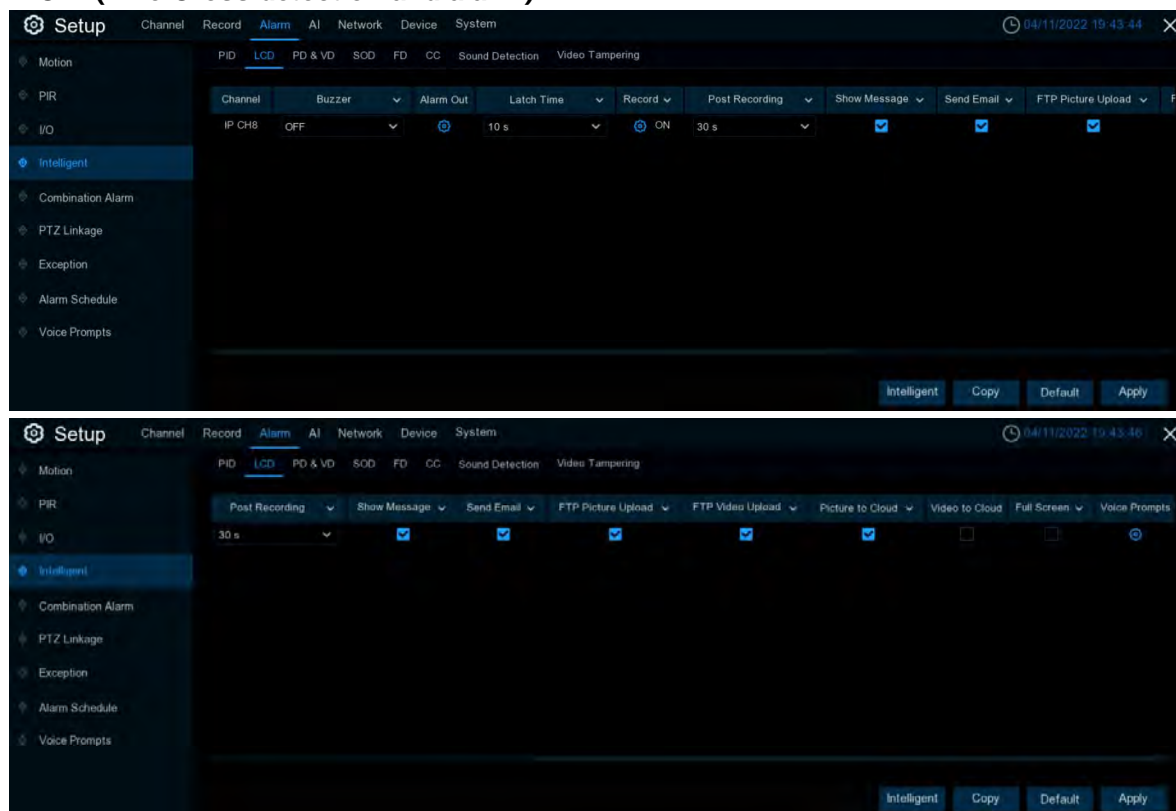

You can configure the LCD over-line detection alarm function here.

**Channel:** Channel name

**Buzzer (buzzer):** The DVR can use its internal buzzer to sound an alarm. You can set the buzzer duration (in seconds) when triggering a perimeter intrusion alarm.

**Alarm out (Alarm output):** Check the external alarm device when the perimeter intrusion alarm is triggered.

**Latch Time (Alarm Trigger Time):** You can set the triggering of the external alarm device in time (10s, 20s, 40s, and 1Min).

**Record (Recording):** Click the icon  and select the channel to record when triggering the perimeter intrusion alarm.

**Post Recording (delayed video recording):** You can set the duration of continuous DVR recording after the event occurs. The suggested recording time is 30 seconds, but can be set to up to 5 minutes.

**Show Message (Display icon):** Select this box to display the icon on the real-time display screen when a perimeter intrusion alarm is detected.

**Send Email (Send Mail):** You can let DVR send you automatic e-mail when perimeter intrusion alarms are detected.

**FTP Picture Upload (FTP image upload):** After triggering the alert, upload the alert picture to the FTP server. See the [5.5.4 FTP](#) for more details

**FTP Video Upload (FTP video upload):** After the alarm is triggered, upload the alarm video to the FTP server. See the [5.5.4 FTP](#) for more details

**Picture to Cloud (Cloud Storage Picture):** After an alert, upload the alert picture to the cloud storage. See [5.6.2 Cloud Storage](#) for more details

**Video to Cloud (Cloud Storage Video):** After an alert is triggered, upload the alert video to the cloud storage. See [5.6.2 Cloud Storage](#) for more details

**Full Screen (Full-screen Display):** If this feature is enabled and a perimeter intrusion alarm is detected in the channel, you will see the channel in full-screen mode.

**Voice Prompts:** Voice prompt, when the alarm is triggered, the audio file imported by voice prompt (IPC to support voice prompt function), details can be seen [5.3.9 voice broadcast](#)

### 5.3.4.3 SOD ((Stationary Object Detection))

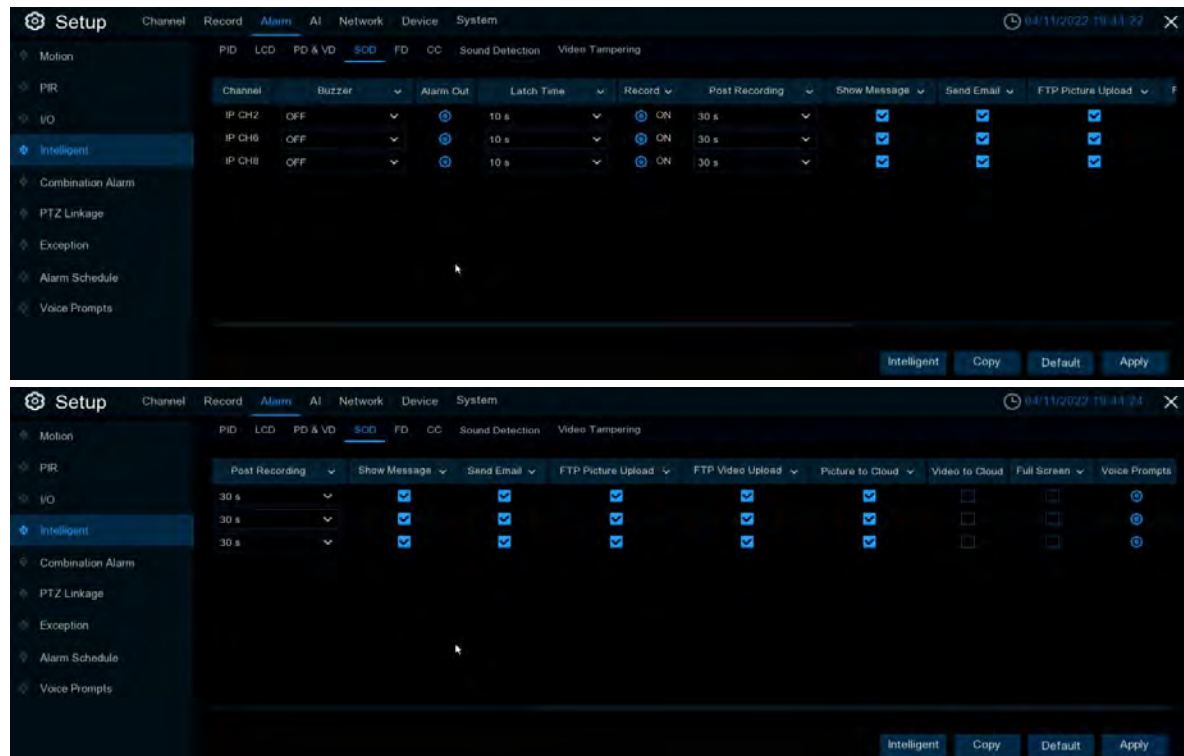

You can configure the SOD function here

**Channel:** Channel name

**Buzzer (buzzer):** The DVR can use its internal buzzer to sound an alarm. You can set the buzzer duration (in seconds) when triggering a perimeter intrusion alarm.

**Alarm out (Alarm output):** Check the external alarm device when the perimeter intrusion alarm is triggered.

**Latch Time (Alarm Trigger Time):** You can set the triggering of the external alarm device in time (10s, 20s, 40s, and 1Min).

**Record (Recording):** Click the icon  and select the channel to record when triggering the perimeter intrusion alarm.

**Post Recording (delayed video recording):** You can set the duration of continuous DVR recording after the event occurs. The suggested recording time is 30 seconds, but can be set to up to 5 minutes.

**Show Message (Display icon):** Select this box to display the icon on the real-time display screen when a perimeter intrusion alarm is detected.

**Send Email (Send Mail):** You can let DVR send you automatic e-mail when perimeter intrusion alarms are detected.

**FTP Picture Upload (FTP image upload):** After triggering the alert, upload the alert picture to the FTP server. See the [5.5.4 FTP](#) for more details

**FTP Video Upload (FTP video upload):** After the alarm is triggered, upload the alarm video to the FTP server. See the [5.5.4 FTP](#) for more details

**Picture to Cloud (Cloud Storage Picture):** After an alert, upload the alert picture to the cloud storage. See [5.6.2 Cloud Storage](#) for more details

**Video to Cloud (Cloud Storage Video):** After an alert is triggered, upload the alert video to the cloud storage. See [5.6.2 Cloud Storage](#) for more details

**Full Screen (Full-screen Display):** If this feature is enabled and a perimeter intrusion alarm is detected in the channel, you will see the channel in full-screen mode.

**Voice Prompts:** Voice prompt, when the alarm is triggered, the audio file imported by voice prompt (IPC to support voice prompt function), details can be seen [5.3.9 voice broadcast](#)

### 5.3.4.4 PD&VD (Pedestrian Detection & Vehicle Detection)

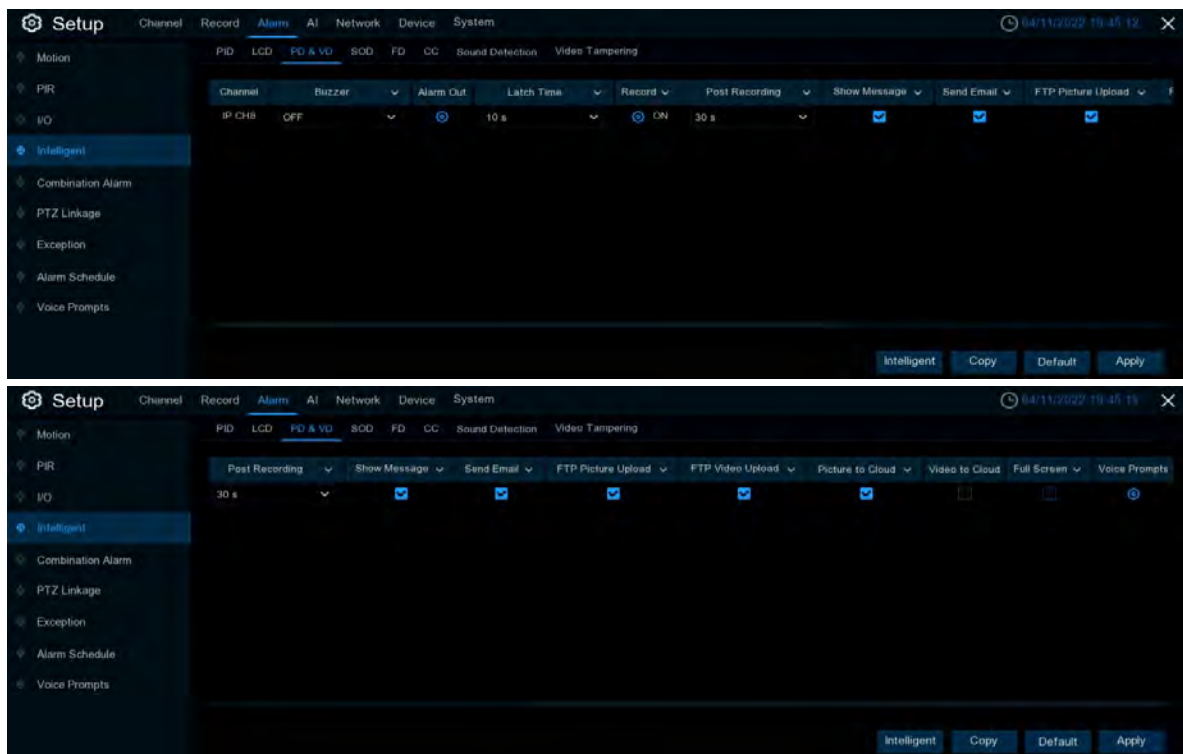

You can configure the PD & VD pedestrian and vehicle detection and alarm function here.

**Channel:** Channel name

**Buzzer (buzzer):** The DVR can use its internal buzzer to sound an alarm. You can set the buzzer duration (in seconds) when triggering a perimeter intrusion alarm.

**Alarm out (Alarm output):** Check the external alarm device when the perimeter intrusion alarm is triggered.

**Latch Time (Alarm Trigger Time):** You can set the triggering of the external alarm device in time (10s, 20s, 40s, and 1Min).

**Record (Recording):** Click the icon  and select the channel to record when triggering the perimeter intrusion alarm.

**Post Recording (delayed video recording):** You can set the duration of continuous DVR recording after the event occurs. The suggested recording time is 30 seconds, but can be set to up to 5 minutes.

**Show Message (Display icon):** Select this box to display the icon on the real-time display screen when a perimeter intrusion alarm is detected.

**Send Email (Send Mail):** You can let DVR send you automatic e-mail when perimeter intrusion alarms are detected.

**FTP Picture Upload (FTP image upload):** After triggering the alert, upload the alert picture to the FTP server. See the [5.5.4 FTP](#) for more details

**FTP Video Upload (FTP video upload):** After the alarm is triggered, upload the alarm video to the FTP server. See the [5.5.4 FTP](#) for more details

**Picture to Cloud (Cloud Storage Picture):** After an alert, upload the alert picture to the cloud storage. See [5.6.2 Cloud Storage](#) for more details

**Video to Cloud (Cloud Storage Video):** After an alert is triggered, upload the alert video to the cloud storage. See [5.6.2 Cloud Storage](#) for more details

**Full Screen (Full-screen Display):** If this feature is enabled and a perimeter intrusion alarm is detected in the channel, you will see the channel in full-screen mode.

**Voice Prompts:** Voice prompt, when the alarm is triggered, the audio file imported by voice prompt (IPC to support voice prompt function), details can be seen [5.3.9 voice broadcast](#)

## 5.3.4.5 FD (face detection)

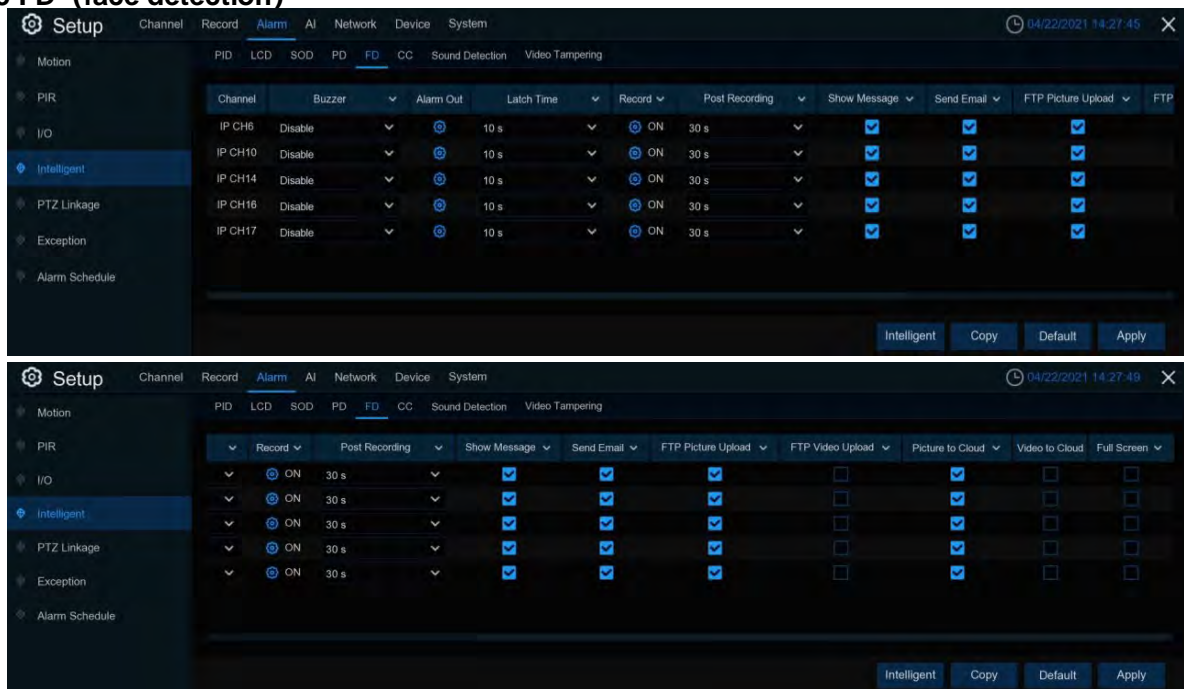

You can configure the FD face detection and alarm function here.

**Channel:** Channel name

**Buzzer (buzzer):** The DVR can use its internal buzzer to sound an alarm. You can set the buzzer duration (in seconds) when triggering a perimeter intrusion alarm.

**Alarm out (Alarm output):** Check the external alarm device when the perimeter intrusion alarm is triggered.

**Latch Time (Alarm Trigger Time):** You can set the triggering of the external alarm device in time (10s, 20s, 40s, and 1Min).

**Record (Recording):** Click the icon and select the channel to record when triggering the perimeter intrusion alarm.

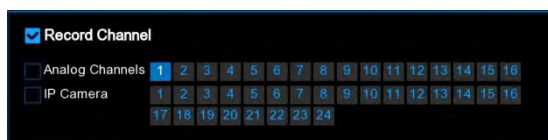

**Post Recording (delayed video recording):** You can set the duration of continuous DVR recording after the event occurs. The suggested recording time is 30 seconds, but can be set to up to 5 minutes.

**Show Message (Display icon):** Select this box to display the icon on the real-time display screen when a perimeter intrusion alarm is detected.

**Send Email (Send Mail):** You can let DVR send you automatic e-mail when perimeter intrusion alarms are detected.

**FTP Picture Upload (FTP image upload):** After triggering the alert, upload the alert picture to the FTP server. See the [5.5.4 FTP](#) for more details

**FTP Video Upload (FTP video upload):** After the alarm is triggered, upload the alarm video to the FTP server. See the [5.5.4 FTP](#) for more details

**Picture to Cloud (Cloud Storage Picture):** After an alert, upload the alert picture to the cloud storage. See [5.6.2 Cloud Storage](#) for more details

**Video to Cloud (Cloud Storage Video):** After an alert is triggered, upload the alert video to the cloud storage. See [5.6.2 Cloud Storage](#) for more details

**Full Screen (Full-screen Display):** If this feature is enabled and a perimeter intrusion alarm is detected in the channel, you will see the channel in full-screen mode.

**Voice Prompts:** Voice prompt, when the alarm is triggered, the audio file imported by voice prompt (IPC to support voice prompt function), details can be seen [5.3.9 voice broadcast](#)



## 5.3.4.6 CC (Cross-Counting)

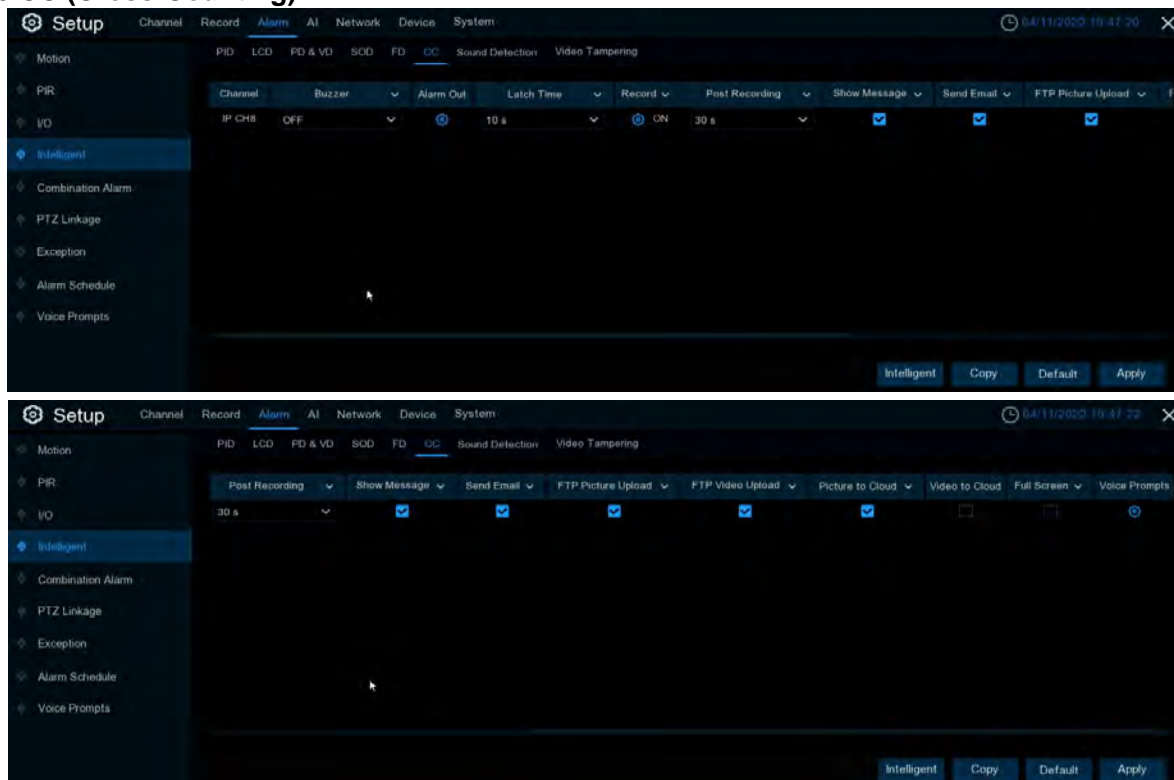

You can configure the CC statistical alarm function here.

**Channel:** Channel name

**Buzzer (buzzer):** The DVR can use its internal buzzer to sound an alarm. You can set the buzzer duration (in seconds) when triggering a perimeter intrusion alarm.

**Alarm out (Alarm output):** Check the external alarm device when the perimeter intrusion alarm is triggered.

**Latch Time (Alarm Trigger Time):** You can set the triggering of the external alarm device in time (10s, 20s, 40s, and 1Min).

**Record (Recording):** Click the icon  and select the channel to record when triggering the perimeter intrusion alarm.

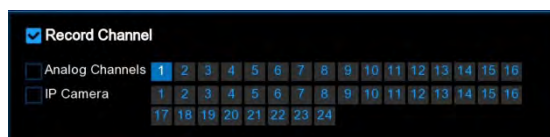

**Post Recording (delayed video recording):** You can set the duration of continuous DVR recording after the event occurs. The suggested recording time is 30 seconds, but can be set to up to 5 minutes.

**Show Message (Display icon):** Select this box to display the icon on the real-time display screen when a perimeter intrusion alarm is detected.

**Send Email (Send Mail):** You can let DVR send you automatic e-mail when perimeter intrusion alarms are detected.

**FTP Picture Upload (FTP image upload):** After triggering the alert, upload the alert picture to the FTP server. See the [5.5.4 FTP](#) for more details

**FTP Video Upload (FTP video upload):** After the alarm is triggered, upload the alarm video to the FTP server. See the [5.5.4 FTP](#) for more details

**Picture to Cloud (Cloud Storage Picture):** After an alert, upload the alert picture to the cloud storage. See [5.6.2 Cloud Storage](#) for more details

**Video to Cloud (Cloud Storage Video):** After an alert is triggered, upload the alert video to the cloud storage. See [5.6.2 Cloud Storage](#) for more details

**Full Screen (Full-screen Display):** If this feature is enabled and a perimeter intrusion alarm is detected in the channel, you will see the channel in full-screen mode.

**Voice Prompts:** Voice prompt, when the alarm is triggered, the audio file imported by voice prompt (IPC to support voice prompt function), details can be seen [5.3.9 voice broadcast](#)

5.3.4.7 Sound Detection



You can configure the Sound Detection sound alarm function here.

**Channel:** Channel name

**Buzzer (buzzer):** The DVR can use its internal buzzer to sound an alarm. You can set the buzzer duration (in seconds) when triggering a perimeter intrusion alarm.

**Alarm out (Alarm output):** Check the external alarm device when the perimeter intrusion alarm is triggered.

**Latch Time (Alarm Trigger Time):** You can set the triggering of the external alarm device in time (10s, 20s, 40s, and 1Min).

**Record (Recording):** Click the icon  and select the channel to record when triggering the perimeter intrusion alarm.

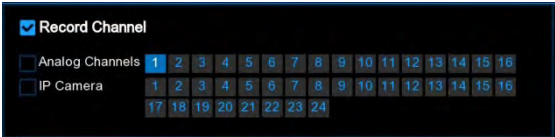

**Post Recording (delayed video recording):** You can set the duration of continuous DVR recording after the event occurs. The suggested recording time is 30 seconds, but can be set to up to 5 minutes.

**Show Message (Display icon):** Select this box to display the icon on the real-time display screen when

a perimeter intrusion alarm is detected.

**Send Email (Send Mail):** You can let DVR send you automatic e-mail when perimeter intrusion alarms are detected.

**FTP Picture Upload (FTP image upload):** After triggering the alert, upload the alert picture to the FTP server. See the [5.5.4 FTP](#) for more details

**FTP Video Upload (FTP video upload):** After the alarm is triggered, upload the alarm video to the FTP server. See the [5.5.4 FTP](#) for more details

**Picture to Cloud (Cloud Storage Picture):** After an alert, upload the alert picture to the cloud storage. See [5.6.2 Cloud Storage](#) for more details

**Video to Cloud (Cloud Storage Video):** After an alert is triggered, upload the alert video to the cloud storage. See [5.6.2 Cloud Storage](#) for more details

**Full Screen (Full-screen Display):** If this feature is enabled and a perimeter intrusion alarm is detected in the channel, you will see the channel in full-screen mode.

**Voice Prompts:** Voice prompt, when the alarm is triggered, the audio file imported by voice prompt (IPC to support voice prompt function), details can be seen [5.3.9 voice broadcast](#)

### 5.3.4.8 Video Tampering

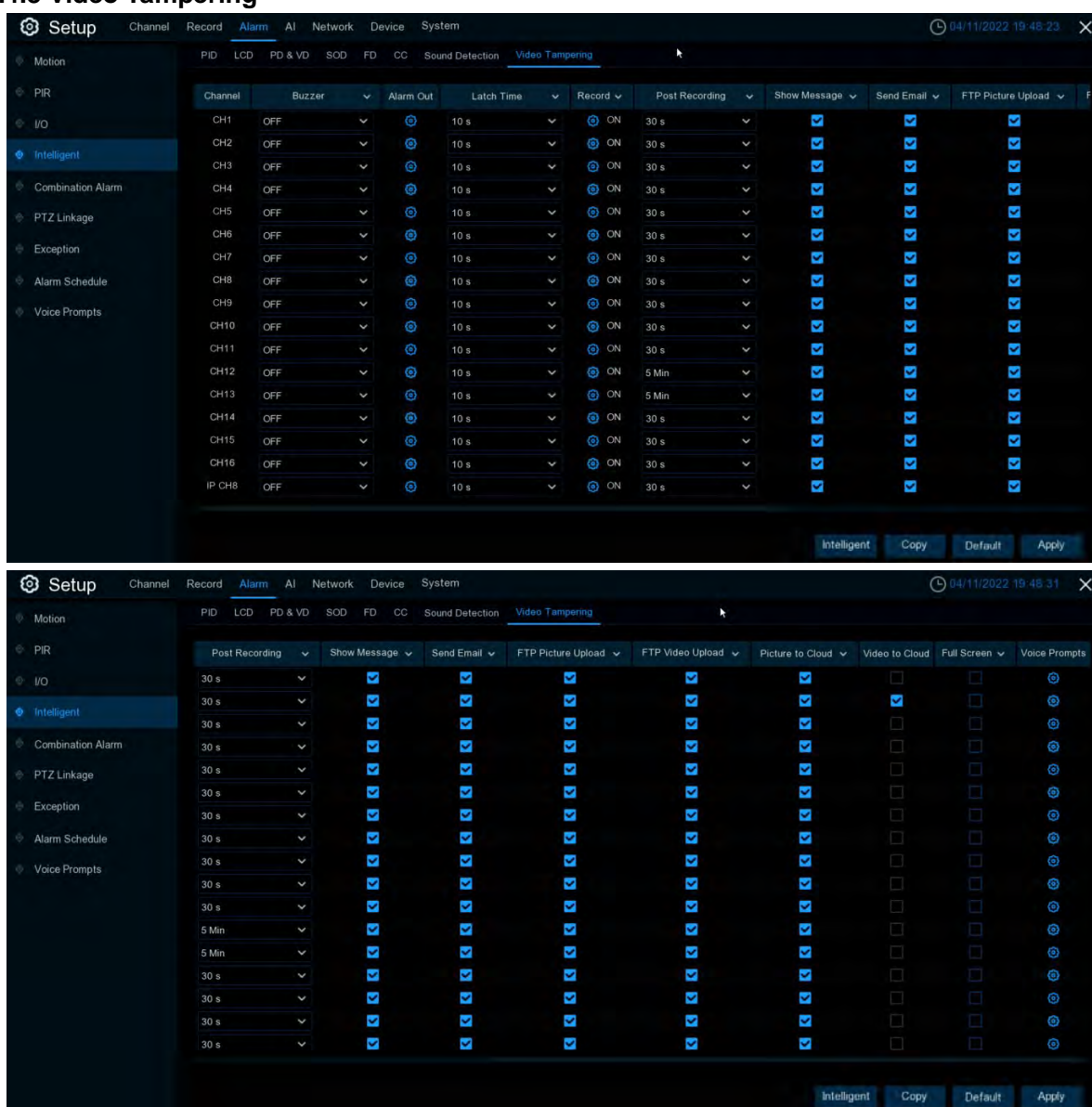

You can configure the Video Tampering video occlusion alarm function here.

**Channel:** Channel name

**Buzzer (buzzer):** The DVR can use its internal buzzer to sound an alarm. You can set the buzzer duration (in seconds) when triggering a perimeter intrusion alarm.

**Alarm out (Alarm output):** Check the external alarm device when the perimeter intrusion alarm is triggered.



**Latch Time (Alarm Trigger Time):** You can set the triggering of the external alarm device in time (10s, 20s, 40s, and 1Min).

**Record (Recording):** Click the icon  and select the channel to record when triggering the perimeter intrusion alarm.

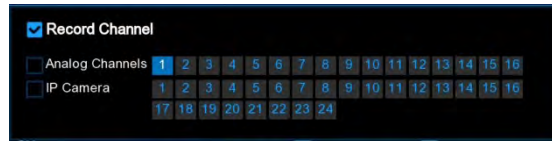

**Post Recording (delayed video recording):** You can set the duration of continuous DVR recording after the event occurs. The suggested recording time is 30 seconds, but can be set to up to 5 minutes.

**Show Message (Display icon):** Select this box to display the icon on the real-time display screen when a perimeter intrusion alarm is detected.

**Send Email (Send Mail):** You can let DVR send you automatic e-mail when perimeter intrusion alarms are detected.

**FTP Picture Upload (FTP image upload):** After triggering the alert, upload the alert picture to the FTP server. See the [5.5.4 FTP](#) for more details

**FTP Video Upload (FTP video upload):** After the alarm is triggered, upload the alarm video to the FTP server. See the [5.5.4 FTP](#) for more details

**Picture to Cloud (Cloud Storage Picture):** After an alert, upload the alert picture to the cloud storage. See [5.6.2 Cloud Storage](#) for more details

**Video to Cloud (Cloud Storage Video):** After an alert is triggered, upload the alert video to the cloud storage. See [5.6.2 Cloud Storage](#) for more details

**Full Screen (Full-screen Display):** If this feature is enabled and a perimeter intrusion alarm is detected in the channel, you will see the channel in full-screen mode.

**Voice Prompts:** Voice prompt, when the alarm is triggered, the audio file imported by voice prompt (IPC to support voice prompt function), details can be seen [5.3.9 voice broadcast](#)

### 5.3.5 Combined alarm

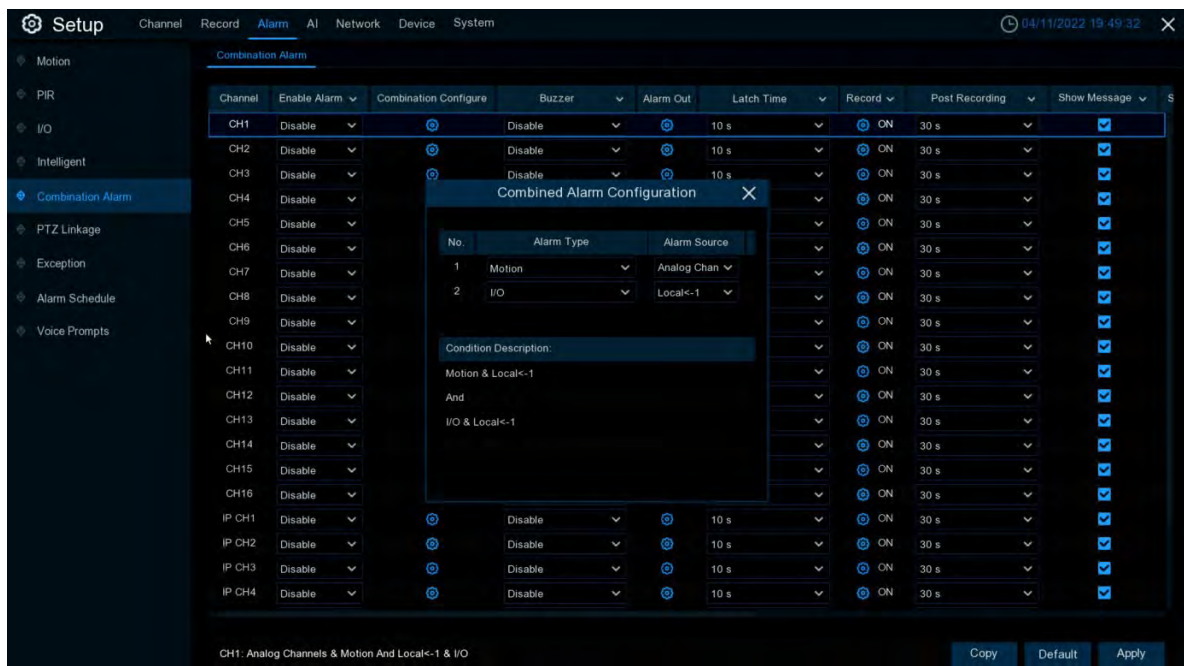

**Channel:** Channel name

**Enable Alarm:** can set whether channel combination alarm is enabled, **Enable** enables combination alarm (combined alarm system parameters of channel configuration take effect, alarm parameter set separately by the channel is not effective), **Disable** does not enable combination alarm (combined alarm system parameter configured by the channel is not effective, and event alarm system parameter set separately by the channel will take effect).

Channel combination alarm is opened. **Combination Configure** selects two alarm types. When both alarms are triggered within the same time period, buzzer, mail, push, upload can be enabled. When only one of the alarms is triggered or not in combination, email, push and other notifications will not be sent. Two alarm types can be combined casually.

For example, the channel sets the "combined alarm" as per **PID + MOTION**

1. Configure the CH 1 **Alarm-> Combinaiton Alarm** alarm response system parameters. Configure



the alarm combination type **Motion + PID**. Set up the **Buzzer Alarm Out, Latch time, Record, Post recording, Show Message, Send Email, Picture to Cloud, Video to Cloud, Full Screen, Voice Prompts**.

2. When the CH1 combination alarm switch is opened and **Motion + PID** is triggered at the same time, (the parameters configured by buzzer, mail, push, upload, etc. are not the system alarm parameters configured for the response event). For mail: The client is named by event. If the combined alarm is turned on, if CH4 triggers an alarm other than **Motion + PID alarm**, the other alarm will not respond to the alarm system parameters (such as LCD, SOD, etc.) corresponding to the CH4 Alarm alarm. Turn off the CH4 combination alarm switch, and the each set event alarm of CH4 individually responds to the respective configured system alarm parameters.

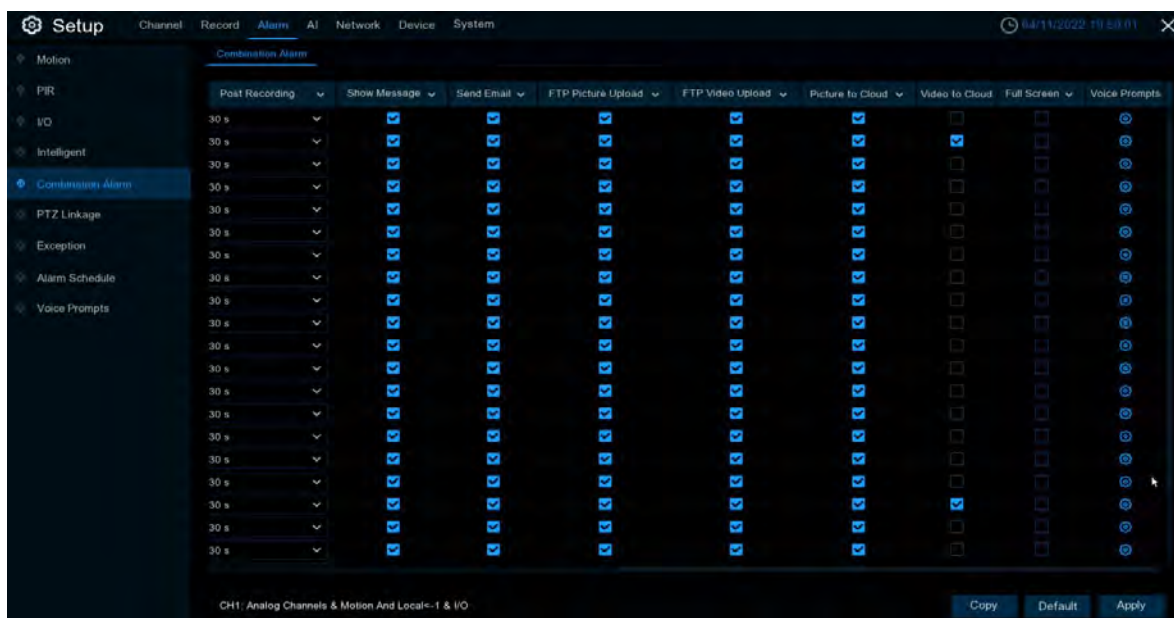

**Buzzer (buzzer):** The DVR can use its internal buzzer to sound an alarm. You can set the buzzer duration (in seconds) when triggering a perimeter intrusion alarm.

**Alarm out (Alarm output):** Check the external alarm device when the perimeter intrusion alarm is triggered.

**Latch Time (Alarm Trigger Time):** You can set the triggering of the external alarm device in time (10s, 20s, 40s, and 1Min).

**Record (Recording):** Click the icon  and select the channel to record when triggering the perimeter intrusion alarm.



**Post Recording (delayed video recording):** You can set the duration of continuous DVR recording after the event occurs. The suggested recording time is 30 seconds, but can be set to up to 5 minutes.

**Show Message (Display icon):** Select this box to display the icon on the real-time display screen when a perimeter intrusion alarm is detected.

**Send Email (Send Mail):** You can let DVR send you automatic e-mail when perimeter intrusion alarms are detected.

**FTP Picture Upload (FTP image upload):** After triggering the alert, upload the alert picture to the FTP server. See the [5.5.4 FTP](#) for more details

**FTP Video Upload (FTP video upload):** After the alarm is triggered, upload the alarm video to the FTP server. See the [5.5.4 FTP](#) for more details

**Picture to Cloud (Cloud Storage Picture):** After an alert, upload the alert picture to the cloud storage. See [5.6.2 Cloud Storage](#) for more details

**Video to Cloud (Cloud Storage Video):** After an alert is triggered, upload the alert video to the cloud storage. See [5.6.2 Cloud Storage](#) for more details

**Full Screen (Full-screen Display):** If this feature is enabled and a perimeter intrusion alarm is detected in the channel, you will see the channel in full-screen mode.

**Voice Prompts:** Voice prompt, when the alarm is triggered, the audio file imported by voice prompt (IPC to support voice prompt function), details can be seen [5.3.9 voice broadcast](#)

### 5.3.6 PTZ linkage

If you had connected the PTZ cameras, you can set the linkage between PTZ cameras and Motion Alarm and/or external I/O sensor alarm. With the linkage function, you can turn your PTZ cameras focus to the preset point when a motion or I/O alarm happens.

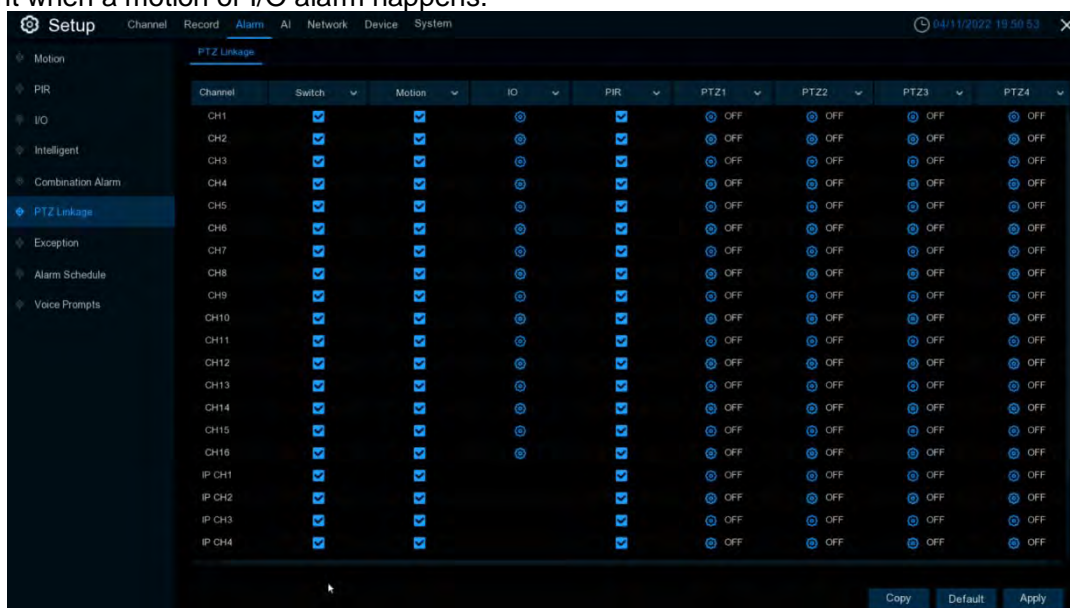

**Switch:** Enable or disable the PTZ linkage function.

**Motion:** Mobile detection will trigger the selected PTZ linkage function.

**IO:** The IO alarm will trigger the selected PTZ linkage function.

**PIR:** The PIR alarm will trigger the selected PTZ linkage function.

**PTZ:** Click the icon  to associate with the preset point of the PTZ camera. [See the 5.1.4 High Speed Ball for more details.](#)

### 5.3.7 Exception

This menu can set the event type for the DVR

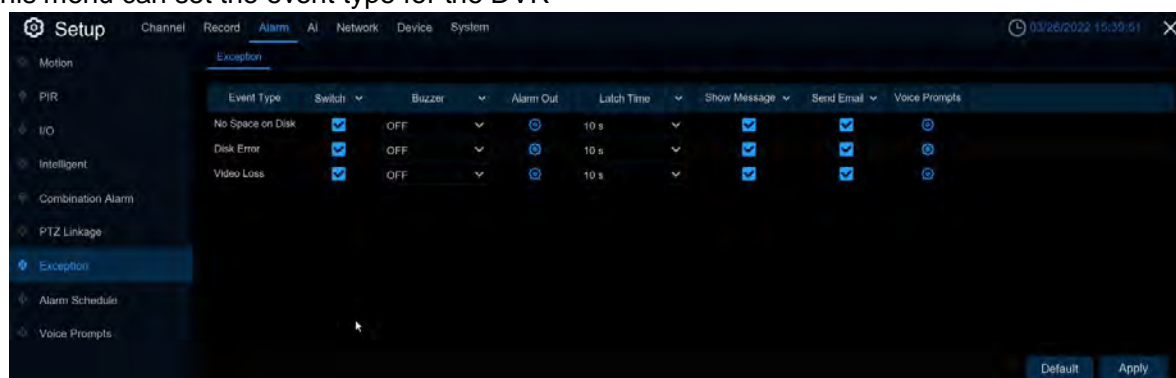

**Event Type (Event Type):** Select the event type from the following options:

**-No Space on Disk: When the hard drive is full.**

**-Disk Error:** If the hard disk readiness is not detected.

**-Video Loss: If a channel is not connected correctly on the**

**Switch (Switch):** Check it off to enable an event alert.

**Buzzer (buzzer):** Set the buzzer duration at the event (off / 10s / 20s / 40s / 1Min). To disable the buzzer, select the OFF.

**Latch Time (Alarm Trigger Time):** You can set the triggering of the external alarm device in time (10s, 20s, 40s, and 1Min).

**Alarm Out (Alarm output):** Check the external alarm device when the abnormal alarm is triggered.

**Show Message (Display icon):** Check the messages on the screen when lack of disk space, disk error or video loss event occurs.

**Send Email (Send Mail):** Let DVR automatically send you e-mail when an event occurs.

**Voice Prompts:** Voice prompt, when the alarm is triggered, the audio file imported by voice prompt (IPC to support voice prompt function), details can be seen [5.3.9 Voice broadcast](#)

5.3.8 Alarm Schedule

In this menu, you can set up alarm call, push, FTP upload, cloud upload, buzzer and other time periods.

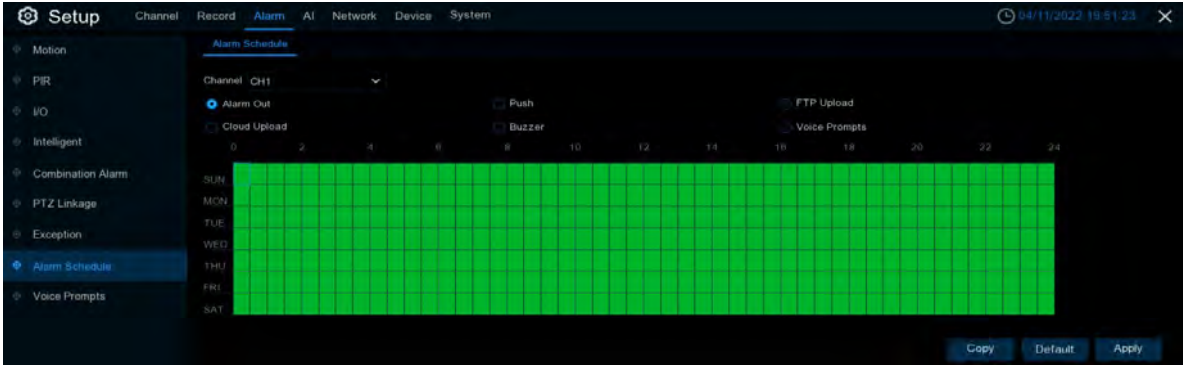

**Channel (Channel):** Select a channel and set its capture parameters. When the slot is marked in green, the channel works for the slot.

5.3.9 Voice broadcast

This function is to realize the alarm occurrence, the system collects the alarm signal and the voice broadcast equipment for linkage, and automatically or manually plays the associated audio to the field "intrusion" object. (For each alarm Alarm settings and the edit page of face images)

5.3.9.1 Document management

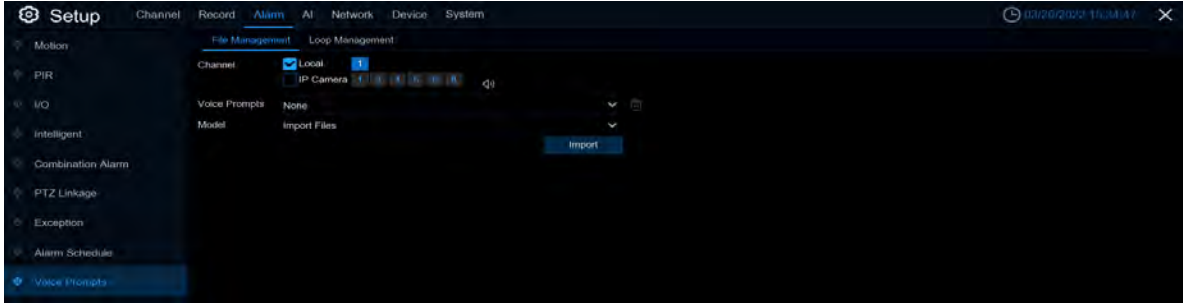

Click import to import the broadcast audio, supporting three audio import methods, namely Import File, Local Conversion and Internet Server Conversion.

**Import File:** Local import (support for audio file import in MP3, WMA, WAV format)

**Local Conversion:** Local translation (input text content to be translated from the device to the hard disk storage automatically)

**Internet Server Conversion:** Network server translation (through the local input of text content to be translated, sent to the network server for translation into audio files, automatically saved to the local hard disk storage)

After importing the broadcast audio, you can select which broadcast audio at the Voice Prompts Voice broadcasting mode, support two broadcasting methods, respectively: Local and IPC channel

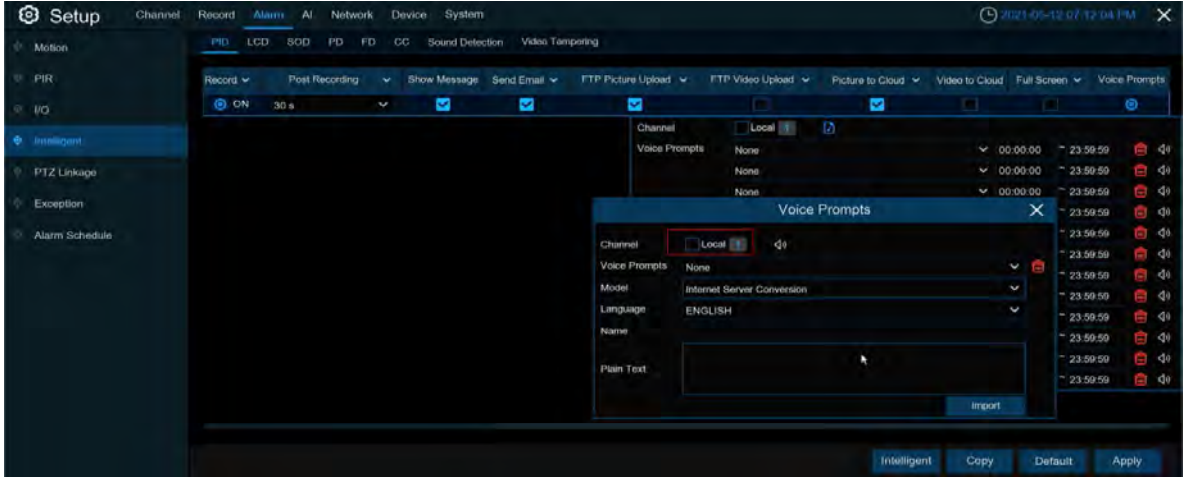



**Local:** Local broadcast (when selecting this broadcast mode, the audio output device is connected to the device side)

**IPC:** Network camera broadcast (the camera program has the voice broadcast function, and the camera side supports the audio output)

Voice broadcast setting by time period: an alarm type can support setting the voice broadcast for up to 12 time periods. There is no conflict between the start and end time of any time period Voice broadcast setting based on face recognition.

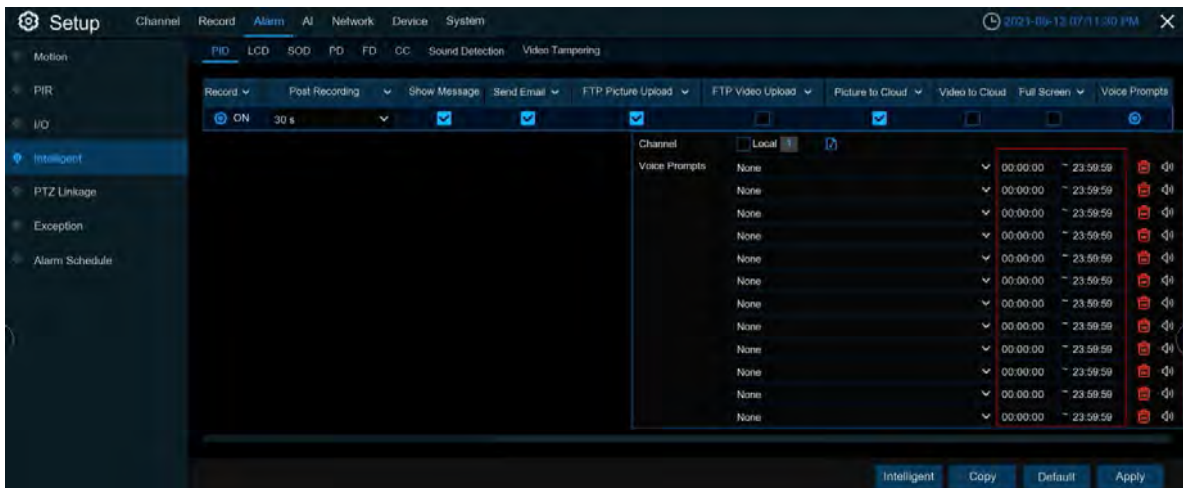

When this function is to realize the face recognition occurs, the system collects the alarm signal and the voice broadcast equipment for linkage, and automatically plays the associated audio to the scene "intrusion" object.(Note: Audio imported based on black and white list face images can only be used for the associated image)

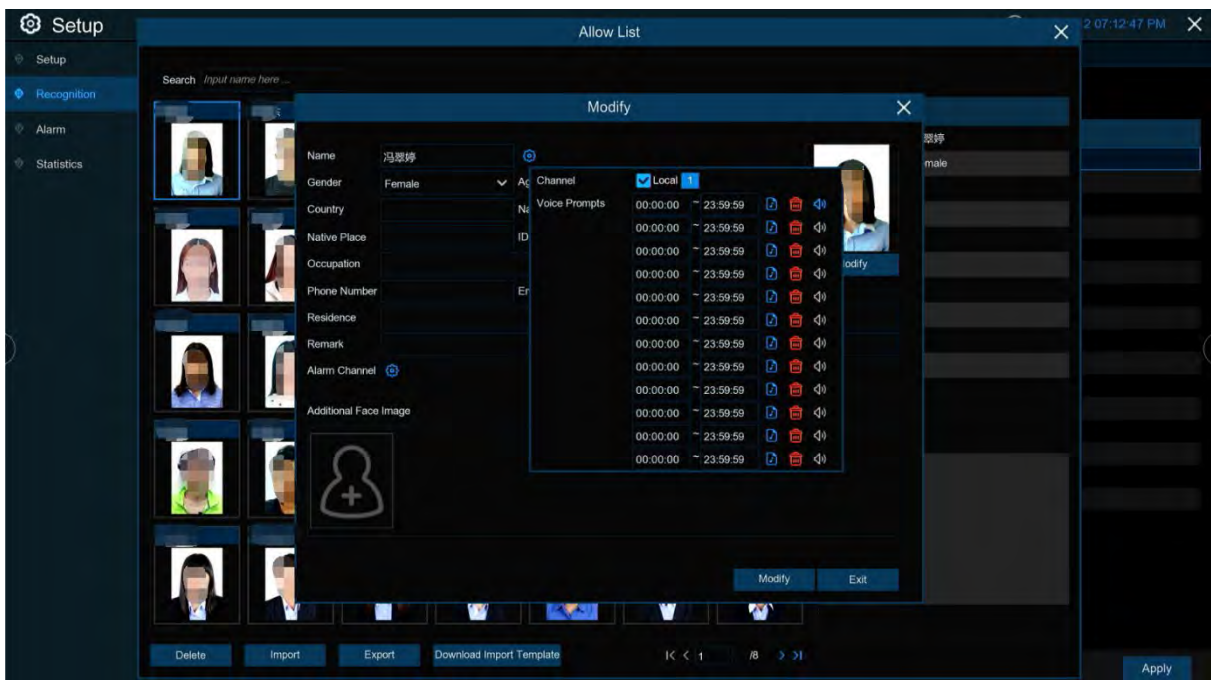

That is, when the face triggers the face detection, there will be a voice broadcast prompt



### 5.3.9.2 loop management

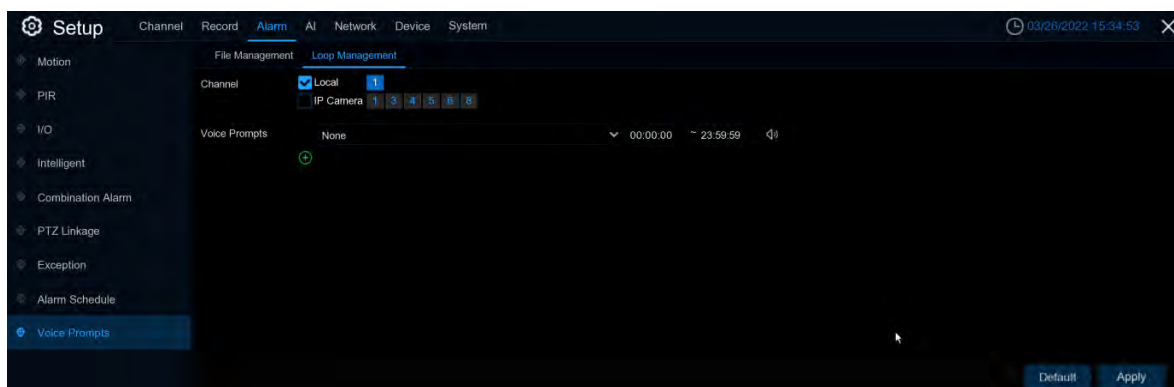

Voice Prompts selects the audio file, and after setting the time period, the selected audio file plays the audio file repeatedly, supporting the voice broadcast for up to 12 time periods.

**Local:** Local broadcast (when selecting this broadcast mode, the audio output device is connected to the device side)

**IPC:** Network camera broadcast (the camera program has the voice broadcast function, and the camera side supports the audio output)

## 5.4 AI

### 5.4.1 Setup

#### 5.4.1.1 Face detection

Set the relevant parameters for face detection on this menu.

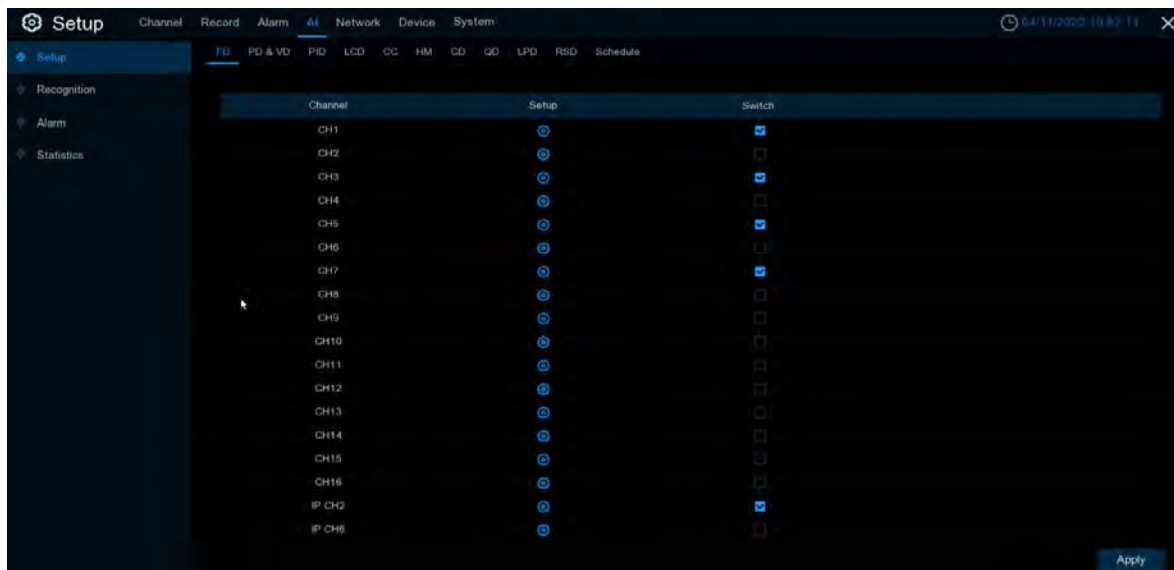

**Setup:** Click  to enter the setting interface.

**Switch:** Turn on or off face detection.

**Channel:** Channel selection

**Snap Mode:** Grasp the picture mode, with the optimal mode (select the best quality picture to push during the time of face appearance to disappearance), real-time mode (push once when the face appears, push again when it disappears) and interval mode (the time and interval of custom push).

**Snap Num:** In interval mode, set the number of grab pictures pushed by faces.

**Snap Frequency:** In the interval mode, set the frequency of the face push.

**Apply Mode:** Set the detection angle, with positive face mode, multi-angle mode, and custom angle mode.

**Roll Range:** At a custom angle, set the range of face rotation.

**Pitch Range:** Set the range of face pitch at a custom angle.

**Yaw Range:** From a custom angle, set the range of the face level flip.

**Frontal view / Muti Angle Defaldu:** restores angle settings by default to forward and multiple angle settings.

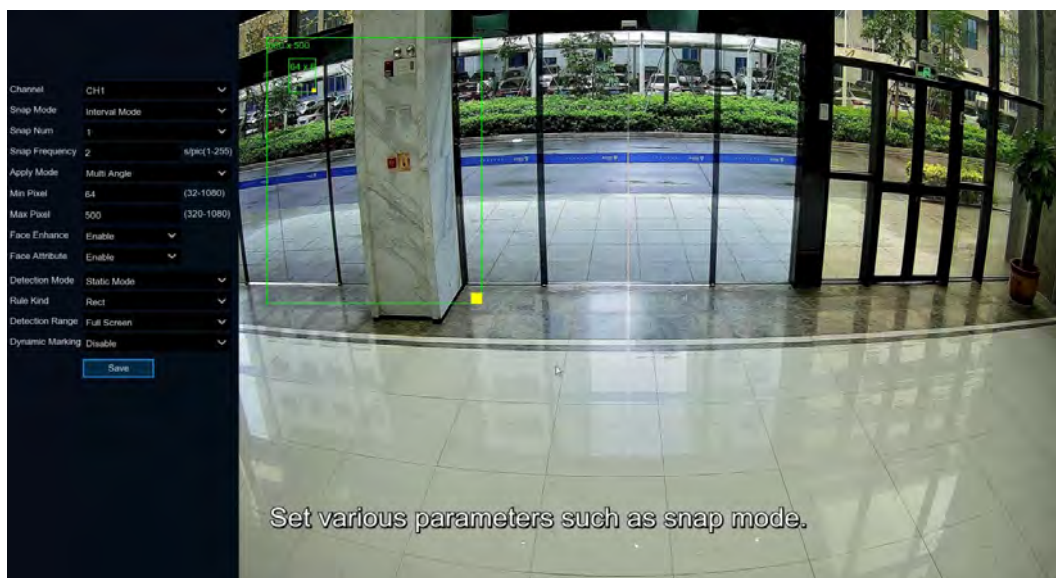

**Picture Quality:** Set the image quality, 1 lowest, 100 highest.

**Min Pixel:** Set the minimum recognition pixel box, the face should be greater than the set pixel to be identified.

**Face Enhance:** Face enhancement, open after catching the moving target face effect is enhanced, but will reduce the overall quality of the picture.

**Face Attribute:** Face attribute switch, which can detect whether faces wear masks, glasses and expressions.

**Detection Mode:** Detection mode is both static and dynamic. Movement check, only the target in the picture is the movement state is check.

**Static mode:** Both still targets and dynamic targets are checked. The motion check mode mainly prevents false positives, such as face-like targets (such as posters and statues), which are still in the picture and do not trigger an alarm.

**Rule Kind:** Rule type. There are both rectangular and linear rules.

**Detection Range:** Under the rectangular rules, set up the detection area. Customizable, with the default full-screen area.

**Rule Type:** Under the linear rule, set the crossing rule. You need to underline the right preview. When the face follows the set rules A B or B A over the line, it is detected. . □ □

**Dynamic Marking:** Snap box display switch

**(Note:** When triggering the Face Detection (face detection), The "S" will appear on the preview screen, in addition, Face Detection is mutually exclusive with Human & Vehicle Detection, Perimeter Intrusion Detection, Line Crossing Detection, Cross Counting, Crowd Density Detection, Queue Length Detection, Licence Plate Detection, not to open simultaneously)

### 5.4.1.2 Pedestrian and vehicle detection

Parameters for pedestrian and vehicle detection are set on this menu

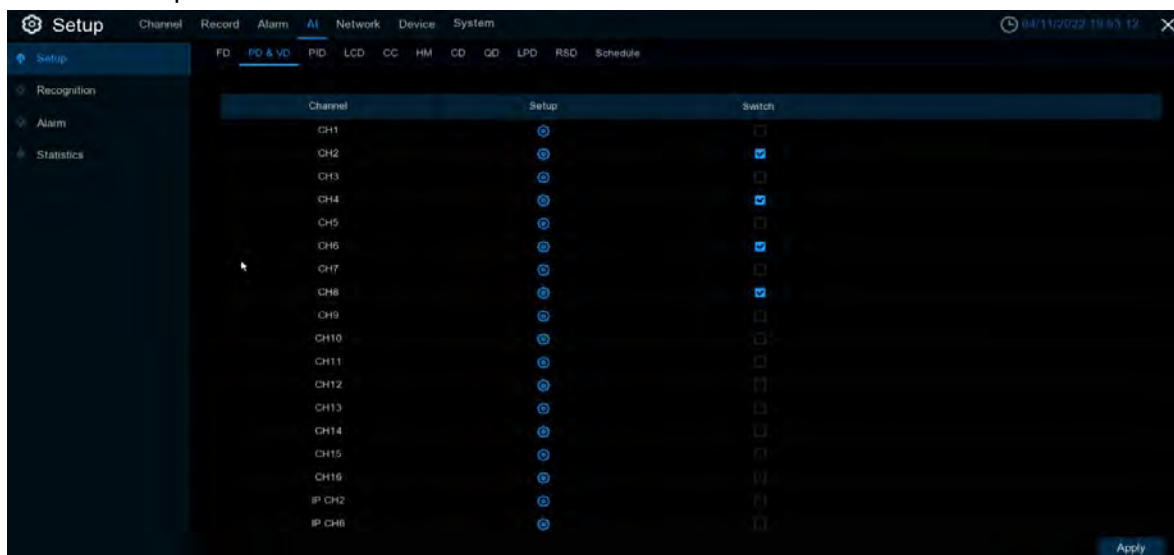

**Setup:** Click  to enter the setting interface.  
**Switch:** enable or close human type & model detection.



**Channel:** Channel selection

**Snap Mode:** Catch mode, with default mode (select the best quality picture push during the period from person & car to disappear), real-time mode (push once when appearing, push again when disappearing) and interval mode (the time and interval of custom push).

**Snap Num:** In interval mode, set the number of grab pictures pushed by faces.

**Snap Frequency:** In the interval mode, set the frequency of the face push.

**Min pixel:** Set the minimum identification pixel box, the person and car should be greater than the set pixels to be identified.

**MX pixel:** Set the maximum recognition pixel box, the person and car should be less than the set pixels to be identified.

**Sensitivity:** Set sensitivity, 1 minimum, 100 maximum.

**Detection Type:** Set the detection type, can be selected type, motor vehicle type, non-motor vehicle type or all selected.

**Detection Mode:** Set the static or dynamic mode.

**Detvion Range:** Set the detection range, customizable, and default full screen.

**Dynamic Marking:** Snap box display switch

(Note: When the Human & Vehicle Detection (pedestrian and vehicle detection) is triggered, the "S" will appear on the preview screen, in addition, Human & Vehicle Detection is mutually exclusive with Face Detection, Perimeter Intrusion Detection, Line Crossing Detection, Cross Counting, Crowd Density Detection, Queue Length Detection, Licence Plate Detection, not to open simultaneously)

### 5.4.1.3 Perimeter invasion detection

Perimeter intrusion detection function can detect people, vehicles or other objects in and out of a predetermined virtual area, and take certain specific measures when an alarm is triggered.

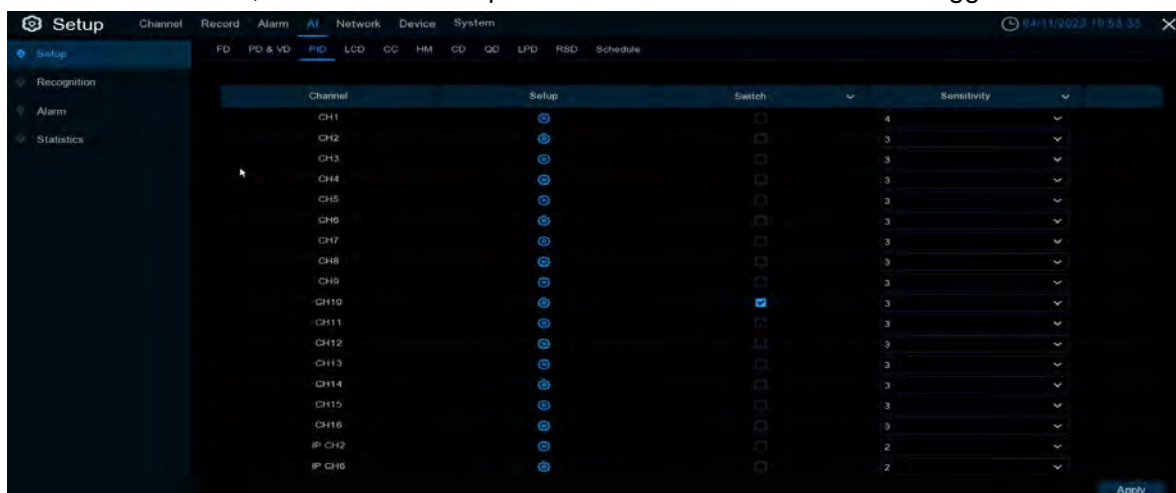



**Switch (Switch):** Turn on or disable this function

**Sensitive (sensitivity):** It has a sensitivity level of 1 to 4. Higher sensitivity will be easier to trigger detection.

**Area (Monitoring area):** Click Setup  to row the virtual area in the image



Set various parameters such as detection type.

1. **Channel:** Select the channel that you want to configure

2. **Detection, Type: Detection type.**

Person: Pedestrian alarm when pedestrian triggers perimeter intrusion.

Motor Vehicle: Alarm when the motor vehicle triggers the perimeter intrusion.

Non-motorized Vehicle: Alarm when non-motor vehicles trigger a perimeter intrusion.

3. **Rule Number:** Select one of the rule numbers. The PID functionality can set up to 4 areas.

4. **Rule Switch:** Enable detection in the rule switch.

5. **Rule Type:** Select the rule type.

A→B: DVR only detects movements from side A to side B;

B→A: The DVR only detects the actions from side B to side A;

A↔B: DVR will detect the action from plane B to plane A or from plane A to plane B;

6. **Dynamic Marking:** Snap box display switch.

7. Click on 4 points in the camera image to draw a virtual rectangle

8. Click on Save to save the settings

9. If you want to change the position or size of the rectangle, click the red box in the rectangle, and the color of the rectangular border becomes red.

Long press the left mouse button to move the line, or drag the end of the line segment to modify the length or position of the line

10. If you want to delete a line from the camera picture, click the red box in the line, and then click the **Remove (Remove)** button. Clicking **Remove All (Remove All)** will remove all of the rectangles.

**Note:** The periphery should not be too close to the edge / angle of the camera image because it may not trigger detection when the target passes through the edge / angle.

1) The shape of the region cannot be too narrow / too small because detection may not be triggered when the large target crosses the perimeter

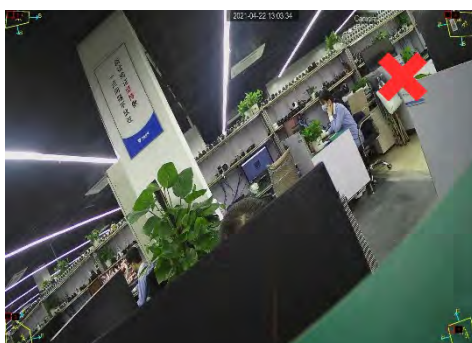



(Note: When the Perimeter Intrusion Detection (perimeter intrusion detection) is triggered, the "S" will appear on the preview screen, In addition, Perimeter Intrusion Detection is mutually exclusive with Human & Vehicle Detection, Face Detection, Line Crossing Detection, Cross Counting, Crowd Density Detection, Queue Length Detection, Licence Plate Detection, Not to open simultaneously)

#### 5.4.1.4 Line Crossing detection

The cross-line detection function detects people, vehicles or other objects crossing a predetermined virtual line and takes certain measures when an alarm is triggered.

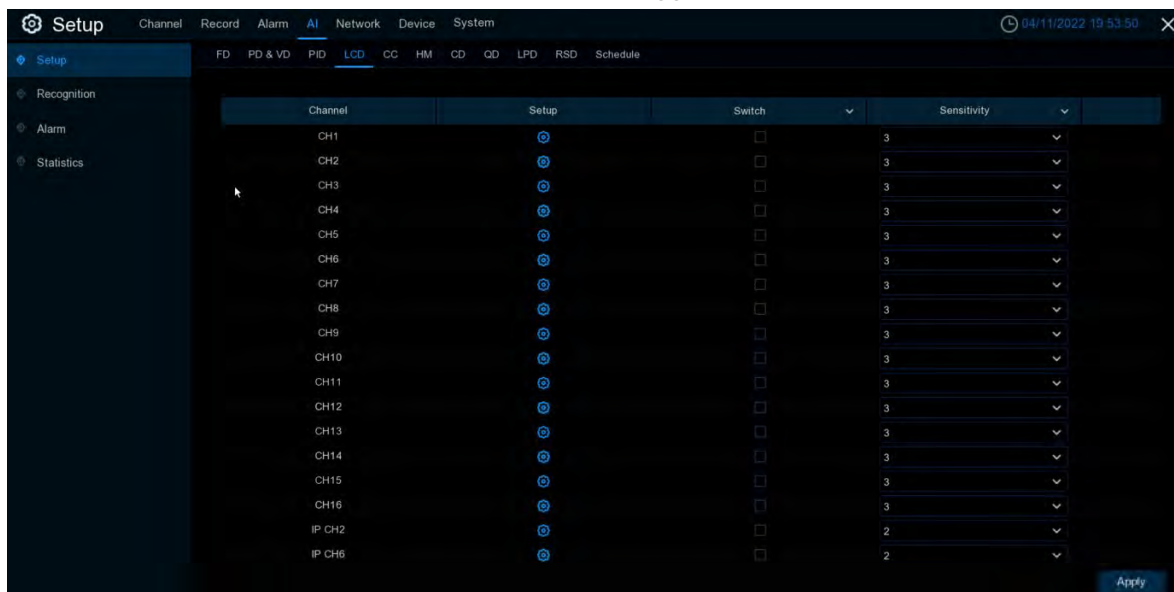

**Switch (Switch):** Turn on or disable this function

**Sensitive (sensitivity):** It has a sensitivity level of 1 to 4. Higher sensitivity will be easier to trigger detection.

**Area (Monitoring area):** Click **Setup** to row the virtual area in the image



1. **Channel:** Select the channel that you want to configure

2. **Detection Type:** Detection type

**Person:** Pedestrian alarm when triggered to cross the line.

**Motor Vehicle:** Alarm when the motor vehicle crosses the line.

**Non-motorized Vehicle:** alarm when the non-motor vehicle crosses the line.

3. **Rule Number:** Select one of the rule numbers. The LCD functionality can set up to 4 areas

4. **Rule Switch:** Enable detection in the rule switch

5. **Rule Type:** Select the rule type

A B: DVR only detects movements from side A to side B;

- B A: The DVR only detects the actions from side B to side A;
- A B: DVR will detect the action from plane B to plane A or from plane A to plane B;

6. **Dynamic Marking:** Snap box display switch.

7. Click on 2 points in the camera image to draw a virtual line.

8. Click on Save to save the settings.

9. If you want to change the position or length of a line, click the red box in the line, and the color of the line becomes red. Long according to the rat Mark left to move the line, or drag the end of the segment to modify the length or position of the line.

10. If you want to delete a line from the camera picture, click the red box in the line, and then click Remove (Remove) push-button. Click Remove All (Remove All) to remove all lines.

**Notice:**

- 1) Lines should not be too close to the edge of the camera image, so as not to trigger an alarm when the target passes through the camera.
- 2) The line should not be set too short to avoid not triggering the alarm when the target crosses the alarm.

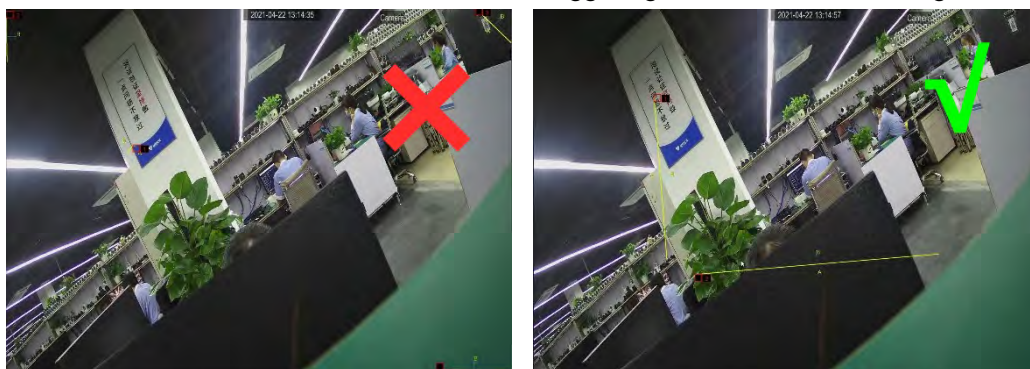

(Note: When Line Crossing Detection (line detection), The "S" will appear on the preview screen, In addition, Line Crossing Detection is mutually exclusive with Perimeter Intrusion Detection and Human & Vehicle Detection, Face Detection, Cross Counting, Crowd Density Detection, Queue Length Detection, Licence Plate Detection, Not to open simultaneously)

**5.4.1.5 Cross Counting statistics**

The Cross Counting statistics function counts people or moving objects.

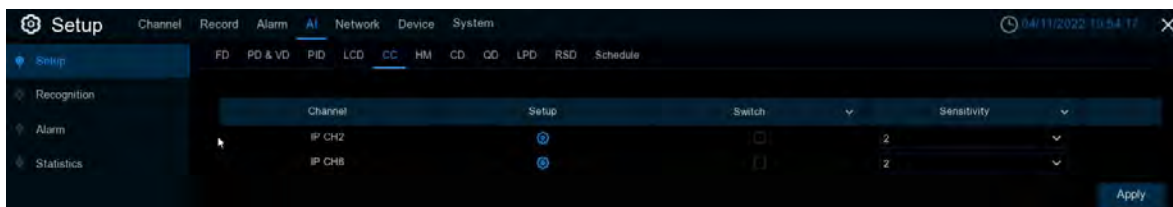

**Sensitive:** Sensitivity level is 1 to 4, and the default value is 2. Higher sensitivity will be easier to trigger detection.

**Switch:** Turn the CC function on or off

**Area:** Click **Setup** to set the virtual lines and rectangle boxes in the camera image



Set various parameters such as detection type.



1. **Channel:** Select the channel that you want to configure.
2. **Type:** Select the rule type  
 Person: count the crossing pedestrians only.  
 Motion: Count any moving object that has crossed the line.  
 Vehicle: count only the crossed vehicles.
3. **Alarm Num:** Set the alert number. Alarm Num= (number of cross in) - (number of cross out), which is in Number of internal supports exists.
4. **Start Time:** Set the count start time.
5. **End Time:** Set the count end time.
6. **Reset Count:** Zero the count and recount.
7. **Rule Number:** Select the rule number. It is the number of virtual lines that you can draw the CC. Up to 1 line.
8. **Rule Switch:** Enables detection rules in the rule switch.
9. **Rule Type:** Rule type  
 A-> B, DVR will count people or items from side A to side B.  
 B-> A, DVR will count people or items from side B to side A.
10. **Dynamic Marking:** Snap box display switch.
11. Click on Save to save your settings.
12. If you want to change the location or range of the rule, click the red box in the line, and the color of the line turns red. Long press the left mouse button to move the line, or drag the endpoint to modify the length or position of the line.
13. If you want to remove a rule from the camera picture, click the red box in the line, and then click Remove (Remove) **push-button. Clicking Remove All (Remove All) removes all rows.**

#### CAUTION:

- 4) The regular line should not be too close to the edge of the camera image to trigger an alarm when the target crosses the line.
- 5) The rule line shall be located in the area accessible to the detected object.
- 6) The rule line should not be set too short to avoid an alarm when the target crosses the alarm.



You can search and view the results of line counting in [5.4.4.3 Overline statistics](#).

(Note: When the Cross Counting (Crossing statistics) is triggered, The "S" will appear on the preview screen, In addition, Cross Counting and Line Crossing Detection work with Perimeter Intrusion Detection, Line Crossing Detection, Human & Vehicle Detection, Face Detection, Crowd Density Detection, Queue Length Detection, and Licence Plate The Detection is mutually exclusive, Not to open simultaneously)

### 5.4.1.6 Heat map

Display the graphics of the popular page area and the geographical area, and the heat map can also tell you which areas of the screen attract most visitors.

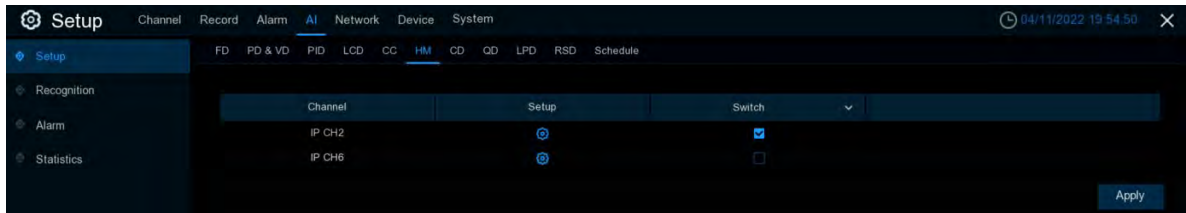

**Switch (Switch):** Turn on or disable this function.

**Area (Monitoring area):** Click **Setup** to row the virtual area in the image.



**Channel:** Select the channel you want to configure

**Rule Number:** Select the rule number. It is the number of areas detected by the heat map. The heat map function can only set up 1 area.

**Rule Switch:** Enable detection in the rule switch.

**Remove:** Click the detection area box and click Remove to remove the detection box.

**Remove All:** Click Remove All to remove the detection box directly.



### 5.4.1.7 Crowd Detection

Population density detection is used to detect population aggregation to maintain controlled order in specific areas.

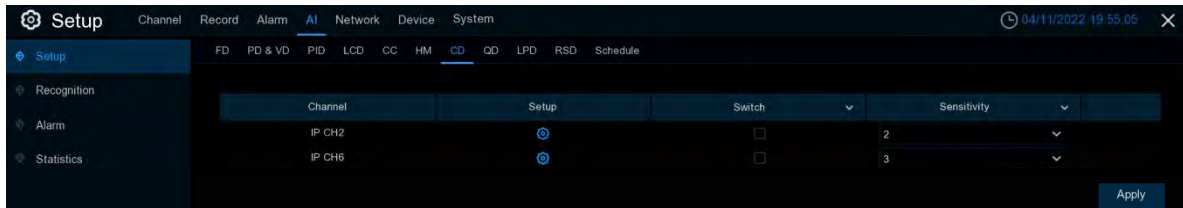

**Switch (Switch):** Turn on or disable this function

**Sensitive (sensitivity):** It has a sensitivity level of 1 to 4. Higher sensitivity will be easier to trigger detection.

**Area (Monitoring area):** Click **Setup** to row the virtual area in the image



**Min pixel:** Set the **minimum** identification pixel box, the person should be greater than the set pixels to be identified.

**MX pixel:** Set the **maximum** recognition pixel box, people need less than the set pixels to be identified.

**Max Detection:** the DVR alarms if the number of people in the detection area exceeds the maximum number of people tested.

**Dynamic Marking:** Snap box display switch.

1. Set the **minimum** and **maximum pixels**.
2. Set the **maximum** detection limit.
3. Enable **detection** in the rule switch.
4. Set the **detection range** to be full-screen or custom-defined.
5. If you select a custom detection range, you need to click the eight points in the camera picture to draw the virtual area.
6. Click on **Save** to save the settings.
7. If you want to change the location or sharpness of the area, click the red box in the area, and the boundary of the area will change to red. Click and hold the left mouse button to move the area, or drag the corner point to resize the area.
8. If you want to remove one of the areas from the camera picture, click the red box in the area, and then click the **Remove** button. Clicking on **Remove All** removes all areas.

### 5.4.1.8 Queuing length detection

Cohort length detection was used to detect the status of the cohort, including its length and stall time.

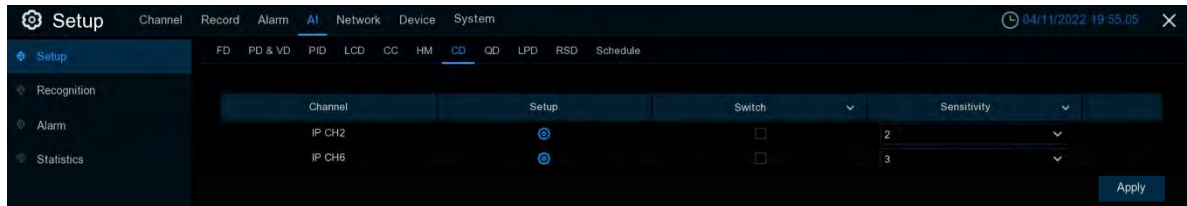

Switch (Switch): Turn on or disable this function

Sensitive (sensitivity): It has a sensitivity level of 1 to 4. Higher sensitivity will be easier to trigger detection.

Area (Monitoring area): Click **Setup** to row the virtual area in the image

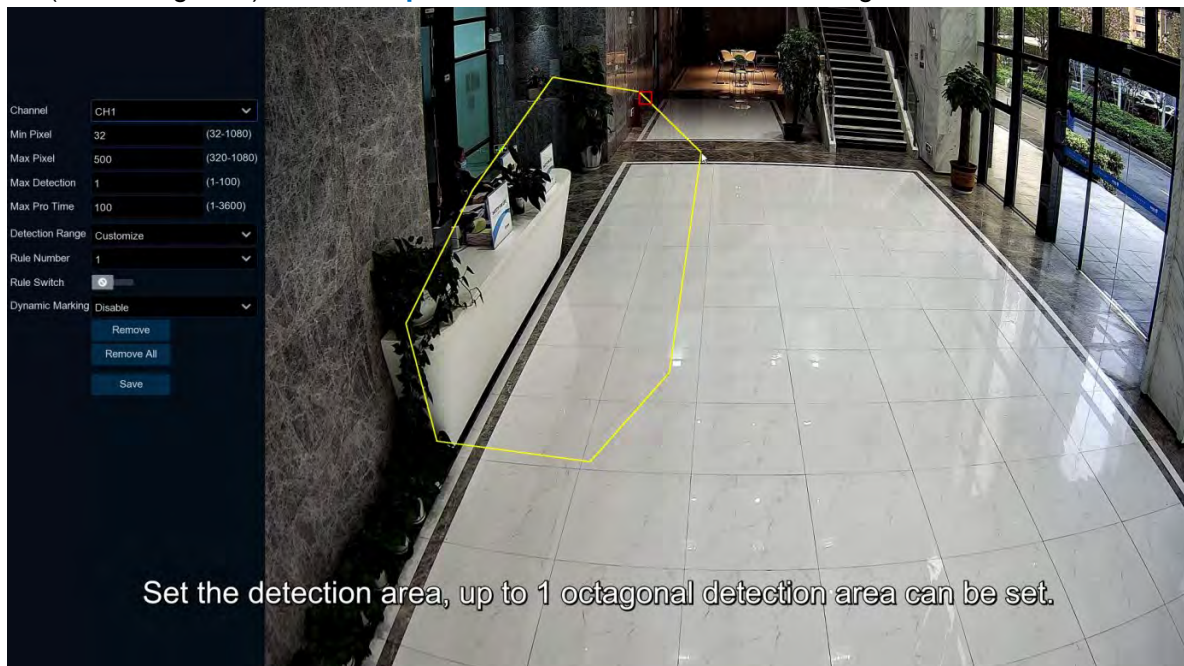

**Min pixel:** Set the minimum identification pixel box, the person should be greater than the set pixels to be identified.

**MX pixel:** Set the maximum recognition pixel box, people need less than the set pixels to be identified.

**Max Detection:** If the number of people queuing in the detection area exceeds the maximum number of people detected, the DVR will alert.

**Max Pro Time:** If the queue stops exceeds the given processing time, the DVR sends an alert.

**Dynamic Marking:** Snap box display switch.

1. Set the **minimum** and **maximum** pixels.
2. Set the **maximum** detection limit.
3. Set the limit number of the **maximum detection time**, measured in seconds.
4. Enable detection in the rule **switch**.
5. Set the **detection range** to full screen or custom.
6. If you select a custom detection range, you need to click the eight points in the camera picture to draw the virtual area.

7. Click on **Save** to save the settings.

8. If you want to change the location or sharpness of an area, click the red box in the area, and the boundary of the area will change to red. Click and hold the left mouse button to move the area, or drag the corner point to resize the area.

9. If you want to **remove** one of the areas from the camera picture, click the red box in the area, and then click the Remove button. Clicking on **Remove All** removes all areas.



### 5.4.1.9 License plate detection

The license plate detection function recognizes whether the license plate of the passing vehicles is an unfamiliar vehicle or the vehicle that has been recorded into the database. At the same time, it can also back up the unfamiliar vehicle license plate information to the database, or retrieve the license plate detection and alarm information for video playback. **License plate testing currently only supports license plates in two regions, Europe and America.**

Set the relevant parameters of the license plate detection on this menu

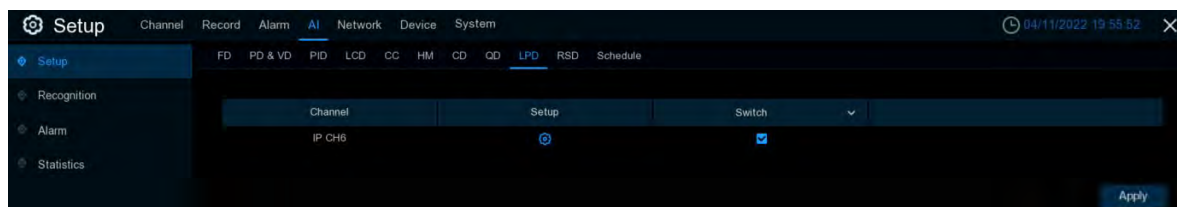

**Setup:** Click  to enter the setting interface.

**Switch:** To enable or close the license plate detection.



#### Channel: Channel selection

**Snap Mode:** Catch mode, with the optimal mode (select the best quality picture push during the period from the vehicle license plate to disappear), real-time mode (push once when the license plate appears, push again) and interval mode (custom push catch number and time interval).

**Min pixel:** Minimum recognition pixel box, the license plate must be greater than the set minimum pixel to be identified.

**Max pixel:** Maximum recognition pixel box, the license plate should be less than the set maximum pixel to be identified.

**Sensitivity:** Sensitivity, the larger the value, the easier to detect the target.

**Detection Type:** There are two types:

**European license plate:** The European license plate,

**American license plate:** American license plate.

**Detection Mode:** License plate detection modes are as follows:

**Static Mode:** Check the static license plate in the picture,

**Motion Mode:** Filter out stationary vehicles and their license plates and detects only detects the plates in the dynamic process.

**Detection Range:** There are two areas for license plate detection as follows:

**Full Screen:** Full-screen detection,

**Customize:** Custom detection area.

**Dynamic Marking:** Display the dynamic detection box.

5.4.1.10 RSD

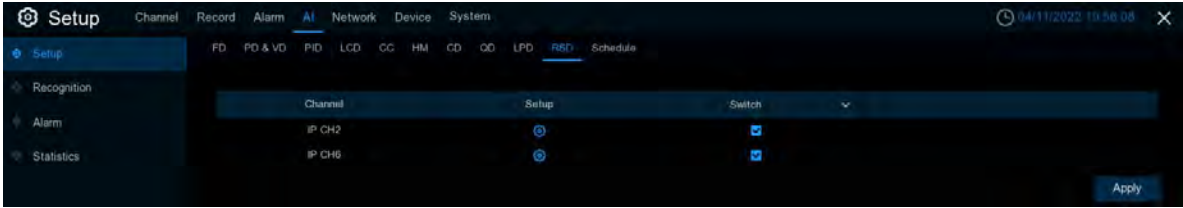

**Setup:** Click  to enter the setting interface.  
**Switch:** Enable or turn off sound exception detection.



**Channel:** Channel selection  
**Sensitivity:** Sensitivity, 1 minimum, 100 maximum.  
**Detection Type:** Detection type  
**Baby Crying Sound:** Baby crying can be detected after checking  
**Dog Barking:** Dog barking can be detected after checking  
**Gunshot:** Gunshots can be detected after checking them

5.4.1.11 Schedule

When IPC connects to DVR with media ports, the schedule is as follows:

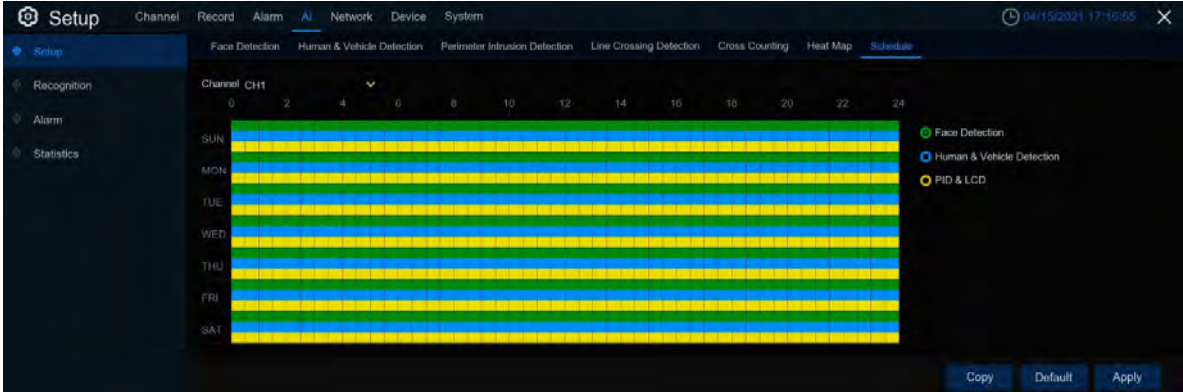

Set the schedule for each AI function recording. Selected as an open, not selected as a close.  
When IPC connects to DVR with WEB port, the schedule is as follows:



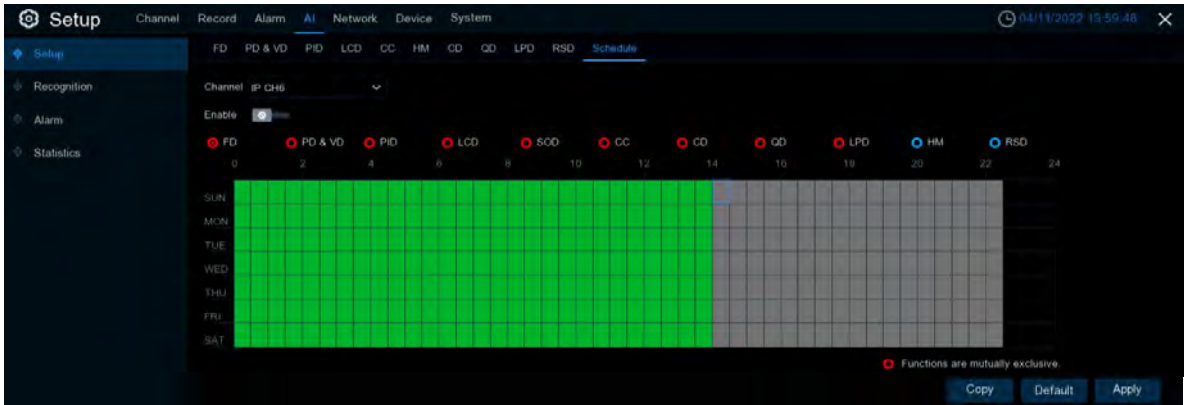

Set the schedule for each AI function switch. Selected is open, not selected for close, gray is not set.

**Enable:** Enable schedules.

**Functions are mutually exclusive:** Features that are mutually exclusive to the selected functions.

### 5.4.2 Recognition

#### 5.4.2.1 Model configuration

Select the algorithm model in this menu. There are local and IPC algorithm models (some devices do not have a local algorithm model and need to take the IPC of the algorithm model).



#### 5.4.2.2 Face Database Management

This menu sets up a database for face recognition contrast.

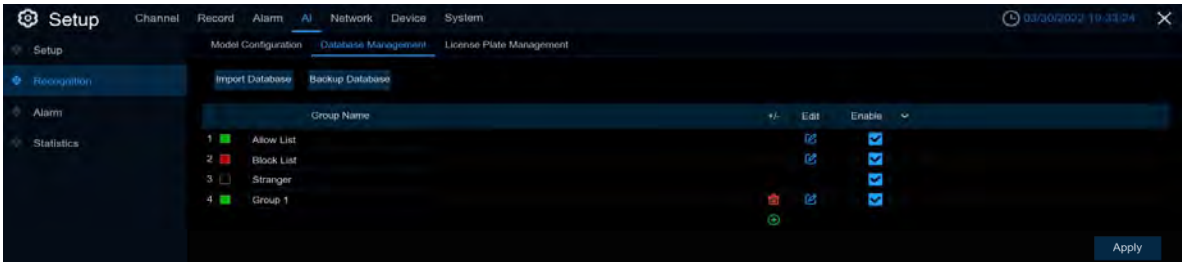



**Import Database:** You can import the exported packet data into the device.

**Backup Database:** You can export all the groups to a U disk.

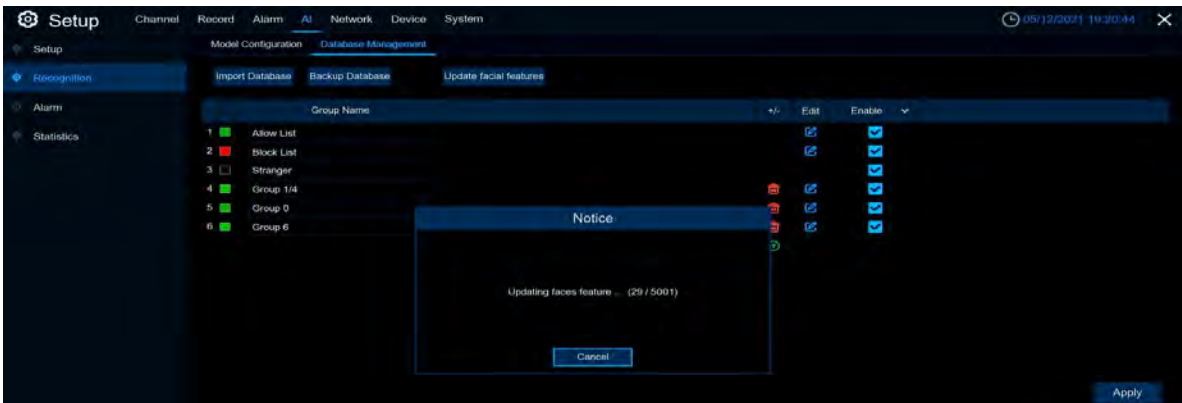
**Update facial features:** update face features, in the face features model or from external files import face images or face library, detected after AI IPC recognize the face image face library face features and the current check face features model is inconsistent, will pop up update face features, click update face features will be shown in the figure below



Click Cancel will pop up a prompt to continue or suspend the update, the remaining not updated next click to update

**Click**  : To add a new face group or delete an existing face group. (The first three face groups brought by default can not be deleted)

**Enable:** Click Edit to enter the Edit face group interface.

**Edit:** Click Edit to enter the Edit face group interface.

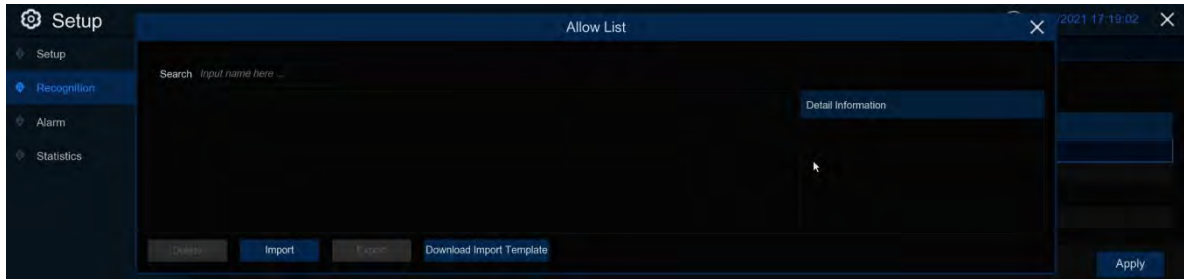

**Import:** Click and select **Local Storage Device** to enter the local interface.

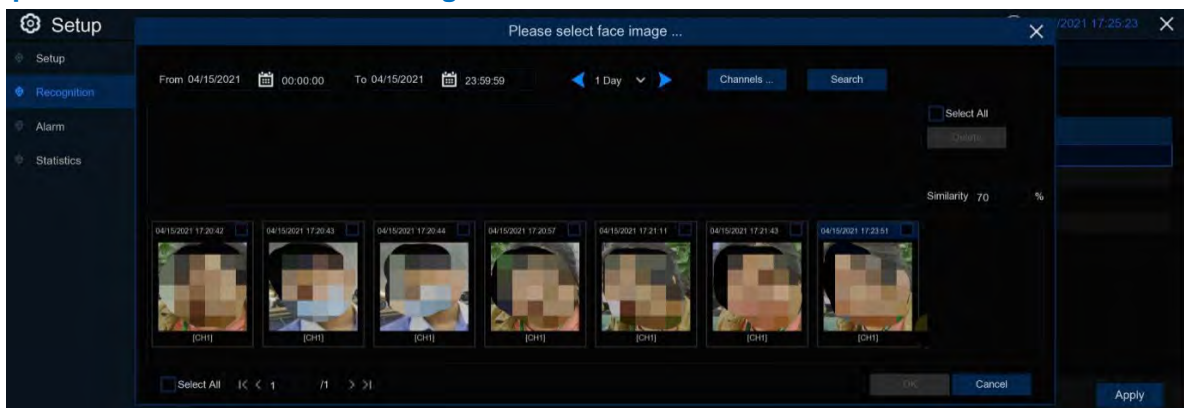

Select the date, duration, and channel back point **Search** to search for the faces saved by all devices during that time. If you select the face and set the similarity and then click **Search**, you will search out the face matching with the selected face similarity, select the face in the search area and click **Delete** to delete the face of this search area. Select the selected face and click OK to enter the input face information interface

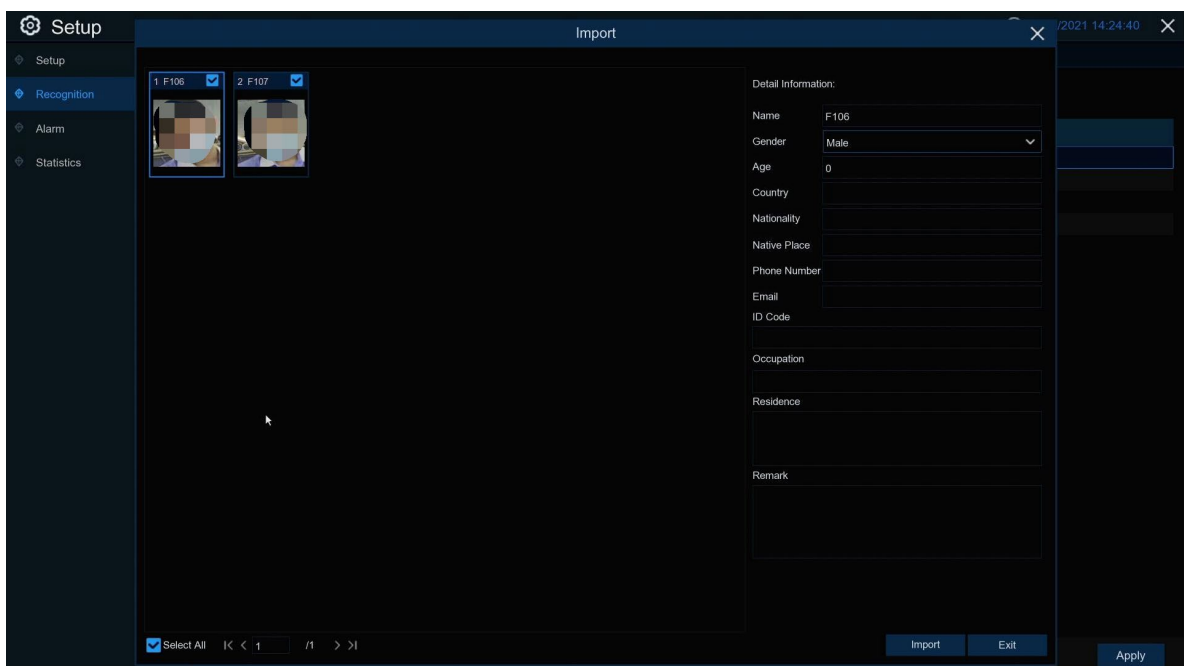

In the right information, you can edit the face information. After editing, click **Import** to complete the import and click Exit to **exit** the interface.

Click **External Storage Device**, enter the external memory, select the face image you want to import, the same step as importing the local face.



**Export:** Export the face picture to external memory, if not click on the face group to click **Export** to export all the face pictures of the face group; click to the face group, then click **Export** to export the selected face picture.

**Download import Template:** Download and import the template, you can export a template to an external memory, this template can contain a form and instructions, you can fill in the face picture information in this form, import this form can modify the information of multiple name face pictures, convenient to modify the face picture information.

Right-click to select the face picture, select **Edit** to enter the face picture editing interface, and click Additional Face image to import the face picture under different circumstances of the face.

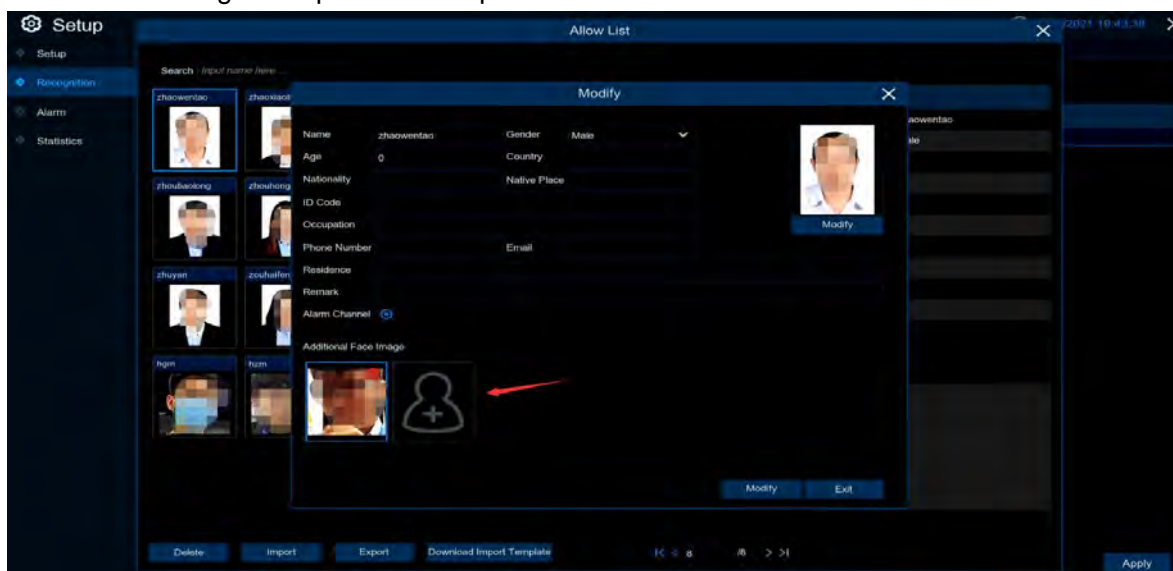

#### 5.4.2.3 License plate database management

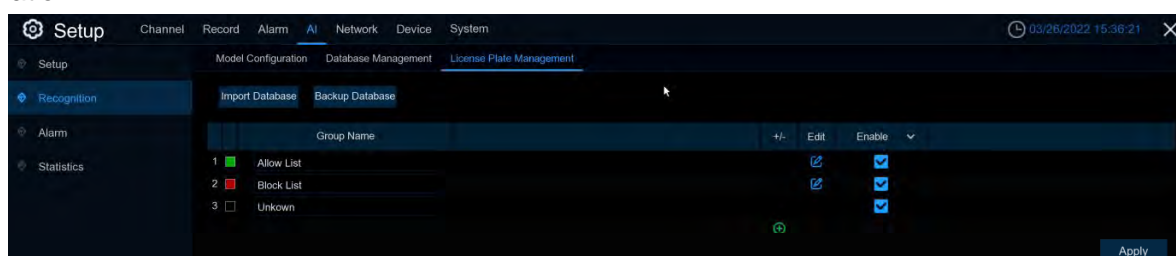

This menu can set up the license plate information database to compare the detected license plate information.



**Import Database:** You can import the exported packet data into the device.

**Backup Database:** You can export all the groups to a U disk.

**Group Name:** The name of the database group  represented as a white list  represented as a blacklist  indicating unfamiliar license plate list, At the same time, you can add up to 61 custom groups, a total of 64 groups, one group can accommodate up to 5000 license plate information, and the whole database can accommodate 10000 license plate information.

**Click  / **: To add a new license plate group or delete an existing license plate group. (The default first three license plate groups must not be deleted)

**Edit:** Click Edit to enter the edit license plate group interface.

**Enable:** The license plate group can be enabled or closed.

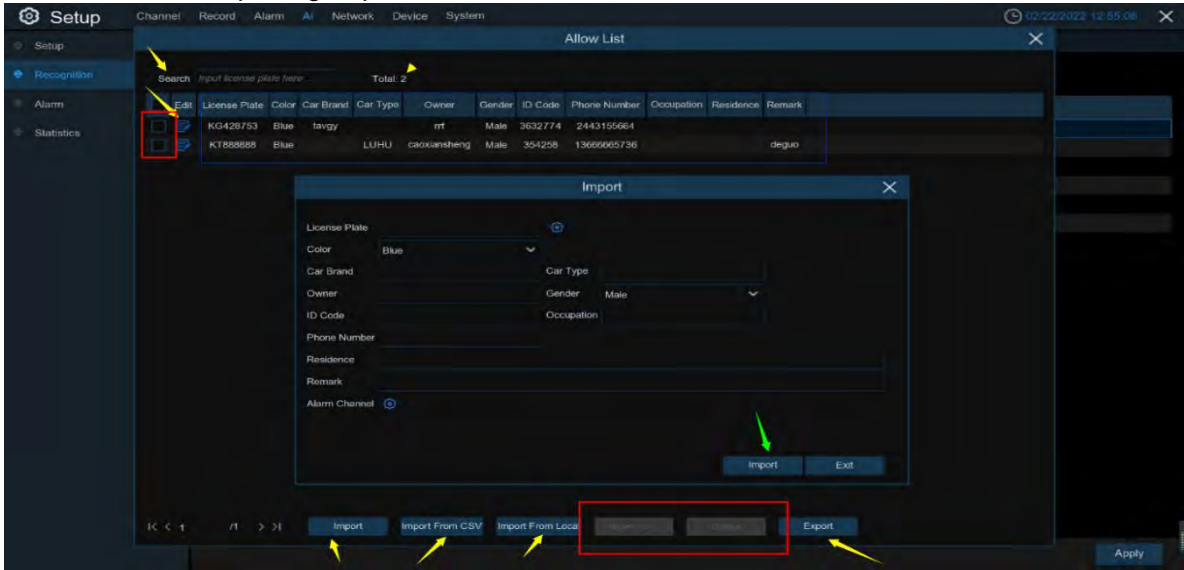

**Search:** Plate filter based on keywords.

**Total:** Total number of license plate data in this group.

Click  to modify the corresponding license plate data information. There are three ways to add license plate information: Import (manually added), Import From CSV (CVS table import), and Import From Local (local import).

Click the **Import** button to manually add a single license plate information,

Click the **Export** button to export the entire group information to the external U disk.

**Alarm Channel:** Set the channel to alarm after the license plate is detected and aligned successfully.

**Move to...** Check the check box of the license plate information and then click this button to transfer the license plate information to another group.

**Delete:** Check the check box of the license plate information and click it again to delete the license plate information.

Click the **Import from CSV** button to import a single or more pieces of data into the CVS table. The format of the CVS table is shown below:

License Plate	Color	Car Brand	Car Type	Owner	Sex	ID Code	Phone	Occupation	Residence	Remark	
4C-38327	blue	HUAWEI	VolvoSUV	YHJ	male	2222	221221	2222	46461	FFQPQFQ	
4C-49225	white	HUAWEI	NORMAL	YHJ	male	105	1111	1111	46461	FFQPQFQ	
8C71947	black	BMW	NORMAL	0000	female	105	2145435	BAFQJBE	FF909	QTFP	
4P18-300	black	KIA	SEDAN	0000	female	105	43225	SPF25	0504	QTFTE	
FA 5905	white	TRUCK	TRUCK	0000	female	104	20220	FFFA	FAA	FFFA	
02 9871	white	BMW	SUV	0000	female	105	238	409	MANAGE	ACBAC	ACET
8 1886	white	BMW	SUV	0000	female	105	2478	408	FFFA	FFFA	FFFA
9 123	white	BMW	SUV	0000	female	105	2478	408	FFFA	FFFA	FFFA
10 1814	white	BMW	SUV	0000	female	105	2478	408	FFFA	FFFA	FFFA
11 1234	white	BMW	SUV	0000	female	105	2478	408	FFFA	FFFA	FFFA
12 912	yellow	BMW	SUV	0000	female	115	46460	FFFA	FFFA	FFFA	
13 913	blue	BMW	SUV	0000	female	115	221223	2222	46471	FFQPQFQ	
14 914	blue	BMW	SUV	0000	female	115	221224	2222	46472	FFQPQFQ	
15 915	blue	BMW	SUV	0000	female	114	221225	2222	46473	FFQPQFQ	
16 916	blue	BMW	SUV	0000	female	115	221226	2222	46474	FFQPQFQ	
17 917	blue	BMW	SUV	0000	female	116	221227	2222	46475	FFQPQFQ	
18 918	blue	BMW	SUV	0000	female	117	221228	2222	46476	FFQPQFQ	
19 919	blue	BMW	SUV	0000	female	118	221229	2222	46477	FFQPQFQ	
20 920	blue	BMW	SUV	0000	female	119	221230	2222	46478	FFQPQFQ	
21 921	blue	BMW	SUV	0000	female	120	221231	2222	46479	FFQPQFQ	
22 922	blue	BMW	SUV	0000	female	121	221232	2222	46480	FFQPQFQ	
23 923	blue	BMW	SUV	0000	female	122	221233	2222	46481	FFQPQFQ	
24 924	blue	BMW	SUV	0000	female	123	221234	2222	46482	FFQPQFQ	
25 925	blue	BMW	SUV	0000	female	124	221235	2222	46483	FFQPQFQ	
26 926	blue	BMW	SUV	0000	female	125	221236	2222	46484	FFQPQFQ	
27 927	blue	BMW	SUV	0000	female	126	221237	2222	46485	FFQPQFQ	
28 928	blue	BMW	SUV	0000	female	127	221238	2222	46486	FFQPQFQ	
29 929	blue	BMW	SUV	0000	female	128	221239	2222	46487	FFQPQFQ	
30 930	blue	BMW	SUV	0000	female	129	221240	2222	46488	FFQPQFQ	
31 931	blue	BMW	SUV	0000	female	130	221241	2222	46489	FFQPQFQ	
32 932	blue	BMW	SUV	0000	female	131	221242	2222	46490	FFQPQFQ	
33 933	blue	BMW	SUV	0000	female	132	221243	2222	46491	FFQPQFQ	
34 934	blue	BMW	SUV	0000	female	133	221244	2222	46492	FFQPQFQ	
35 935	blue	BMW	SUV	0000	female	134	221245	2222	46493	FFQPQFQ	
36 936	blue	BMW	SUV	0000	female	135	221246	2222	46494	FFQPQFQ	
37 937	blue	BMW	SUV	0000	female	136	221247	2222	46495	FFQPQFQ	
38 938	blue	BMW	SUV	0000	female	137	221248	2222	46496	FFQPQFQ	
39 939	blue	BMW	SUV	0000	female	138	221249	2222	46497	FFQPQFQ	
40 940	blue	BMW	SUV	0000	female	139	221250	2222	46498	FFQPQFQ	
41 941	blue	BMW	SUV	0000	female	140	221251	2222	46499	FFQPQFQ	
42 942	blue	BMW	SUV	0000	female	141	221252	2222	46500	FFQPQFQ	
43 943	blue	BMW	SUV	0000	female	142	221253	2222	46501	FFQPQFQ	
44 944	blue	BMW	SUV	0000	female	143	221254	2222	46502	FFQPQFQ	
45 945	blue	BMW	SUV	0000	female	144	221255	2222	46503	FFQPQFQ	
46 946	blue	BMW	SUV	0000	female	145	221256	2222	46504	FFQPQFQ	
47 947	blue	BMW	SUV	0000	female	146	221257	2222	46505	FFQPQFQ	
48 948	blue	BMW	SUV	0000	female	147	221258	2222	46506	FFQPQFQ	
49 949	blue	BMW	SUV	0000	female	148	221259	2222	46507	FFQPQFQ	
50 950	blue	BMW	SUV	0000	female	149	221260	2222	46508	FFQPQFQ	



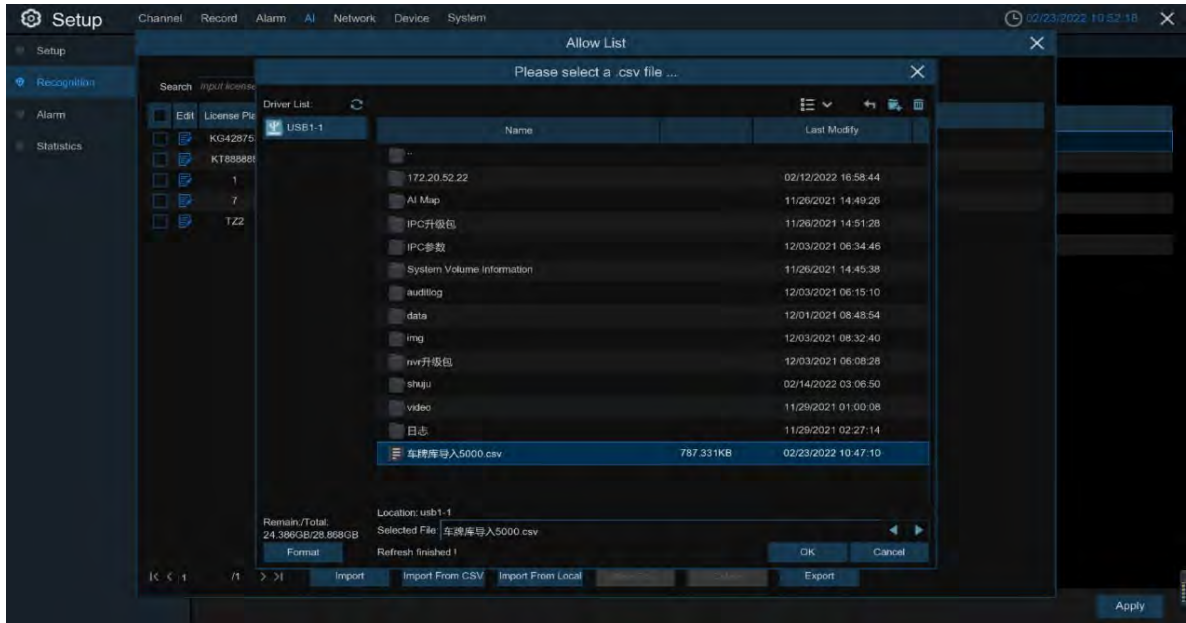

Click **Import from CSV** button to pop up the above interface, select the C SV license plate file to be imported, click **OK** button. Pop up the picture interface below:

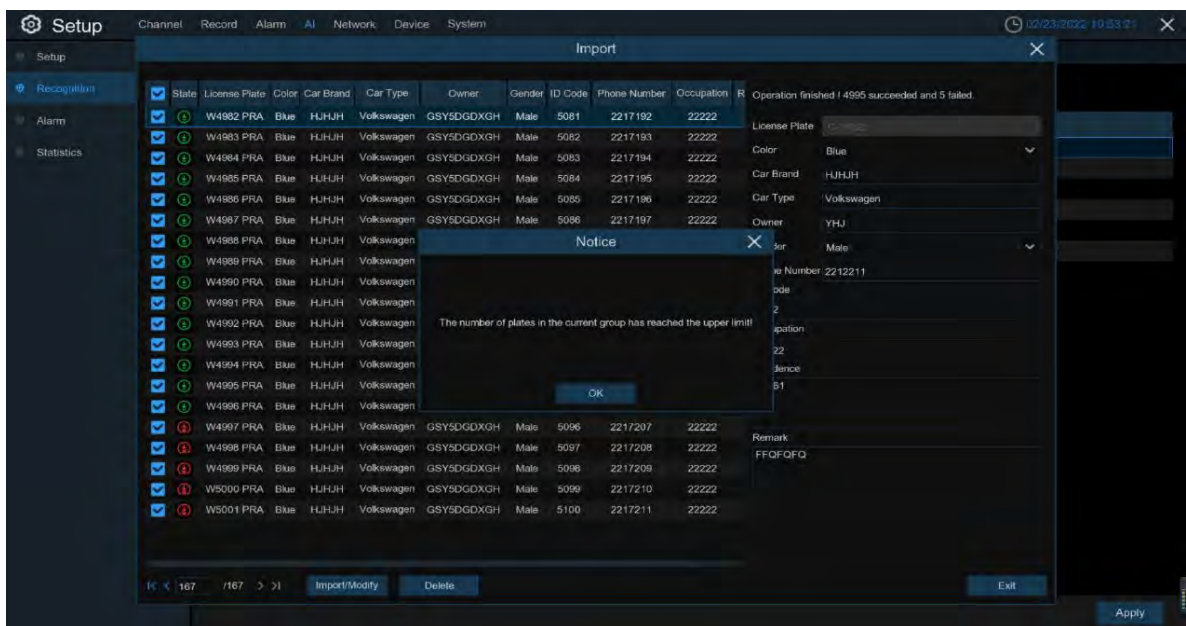

Click the **Import / Modify** button to add a batch, and you can also select a single license plate information to modify it. When more than 5000 data are added, the message box as shown in the figure above is "Add data has reached the upper limit of the group".

Click the **Import From Local** button to import the license plate information locally to the database.

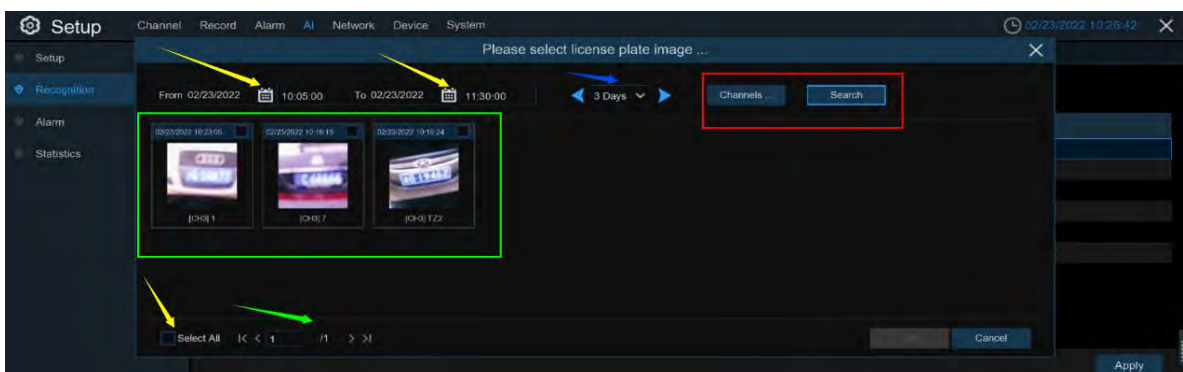

Select the date, duration and channel back point Search to search for license plates saved by all devices during this time.

**Channels:** License plate detection events triggered by each channel.

**Select All:** Select all of the license plate information.

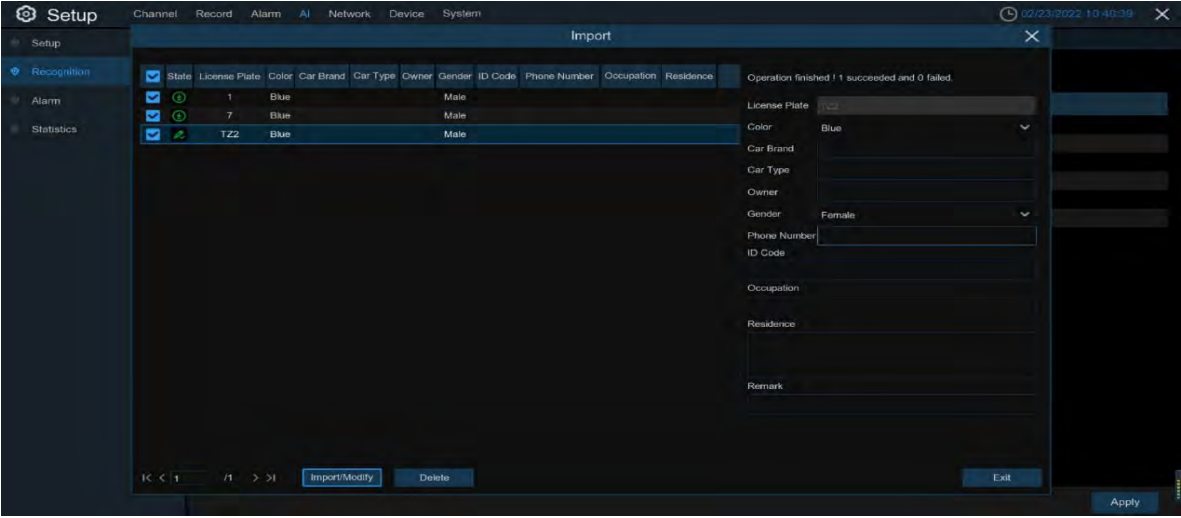

Click a piece of data to edit the license plate information, and click the **Import /Modify** button to modify, if the modification is successful. will be changed to .

### 5.4.3 Alarm settings

#### 5.4.3.1 Face recognition alarm

A series of alarm settings made when faces within the face group are detected.

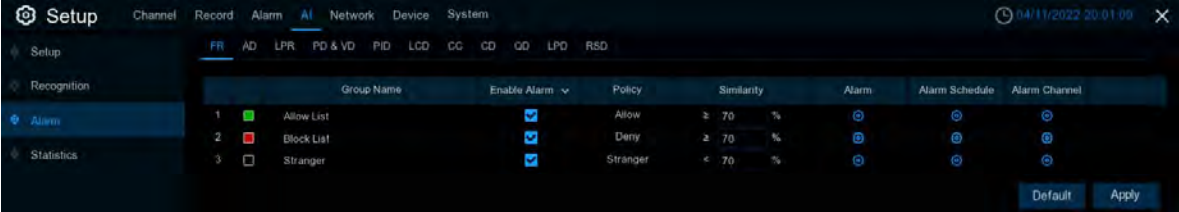

**Enable alarm:** Face detection alarm on or off

**Policy:** Set up the face grouping alarm countermeasures

**Similarity:** The similarity settings

**Alarm:** Click to enter the setting interface.





Alarm Out (Alarm output): optional function. If your DVR supports a connection to an external alert device, you can set up an external alert device.

**Latch Time (alarm trigger time):** Set the external alarm time when the face is detected.

**Save Face:** When a face is detected, the face is saved.

**Save Background:** When a face is detected, the entire preview image is saved.

**Show Thumbnail:** When a face is detected, a thumbnail popup appears on the preview.

**Send Email:** When a face is detected, pictures are sent to the set mailbox.

**FTP Picture Upload:** When a face is detected, the picture is sent to the set FTP server [5.4.4 FTP](#).

**Picture to Cloud:** When a face is detected, pictures will be sent to the set cloud storage server [5.6.2 Cloud Storage](#).

**Alarm Schedule:** Click  to enter the setting plan interface.

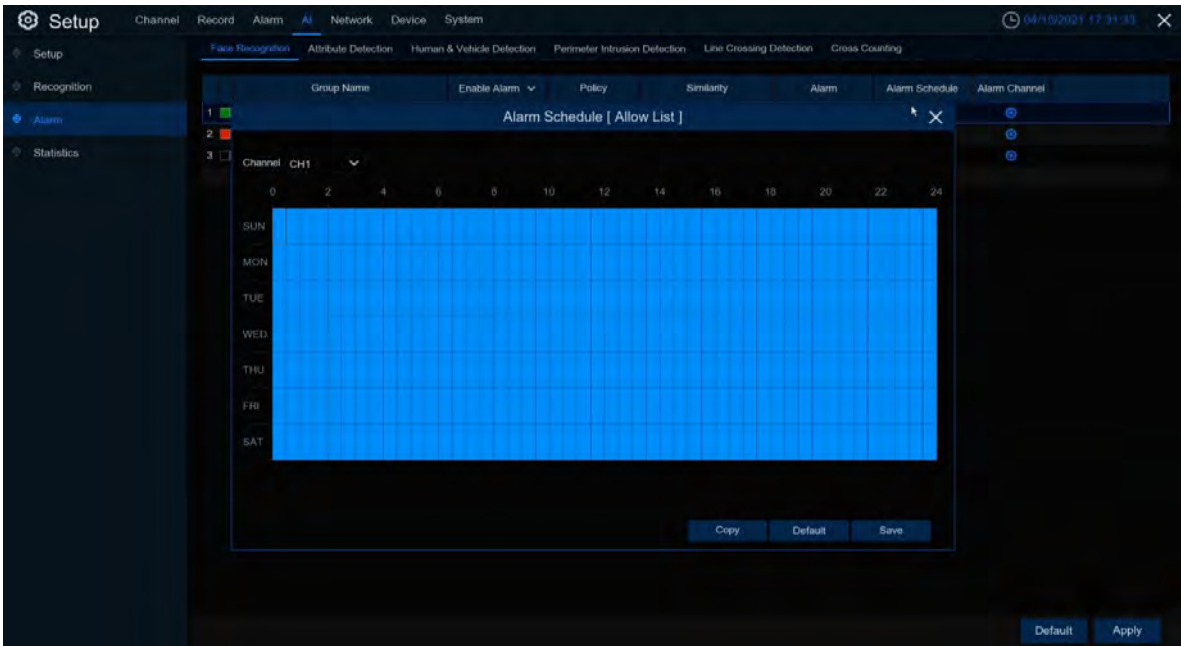

Check the time period **Exit** to alarm and click **Apply**. **Copy** can copy to other channels

**Voice Prompts:** Voice prompt, when the alarm is triggered, the audio file imported by voice prompt (IPC to support voice prompt function), details can be seen [5.3.9 Voice Broadcast](#)



5.4.3.2 Face attribute alarm

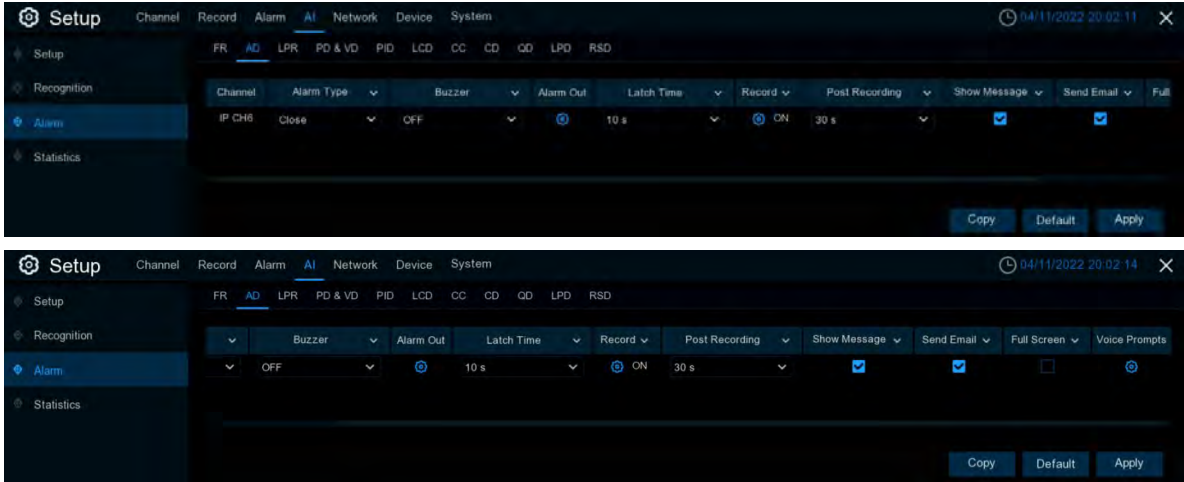

You can configure the face attribute alarm function here.

**Channel:** Channel name

**Alarm Detection:** Set the face attribute alarm type, including close, No Mask without mask and mask Wear Mask.

**Buzzer (buzzer):** The DVR can use its internal buzzer to sound an alarm. You can set the buzzer duration (in seconds) that triggering a pedestrian and vehicle alarm.

**Alarm out (Alarm out):** Check the external alarm device when triggering pedestrian and vehicle alarms.

**Latch Time (Latch Time):** You can set the duration of triggering external alarm devices (10s, 20s, 40s, 40s and 60s).

**Record (Recording):** Click and select the channel to record when triggering a pedestrian and vehicle alarm.



**Post Recording (delayed video recording):** You can set the duration of continuous DVR recording after the event occurs. The suggested recording time is 30 seconds, but can be set to up to 5 minutes.

**Show Message (Display icon):** Select this box to display the icon on the real-time display screen when pedestrian and vehicle alarms are detected.

**Send Email (Send mail):** You can let DVR send you automatic e-mail for pedestrian and vehicle alarms.

**Full Screen (Full screen display):** If this feature is enabled and pedestrian and vehicle alarms are detected in the channel, you will see the channel in full screen mode.

**Voice Prompts:** Voice prompt, when the alarm is triggered, the audio file imported by voice prompt (IPC to support voice prompt function), details can be seen [5.3.9 Voice Broadcast](#)

5.4.3.3 License plate recognition

Set up a series of linkage alarms made when the license plate in the license plate database is detected.

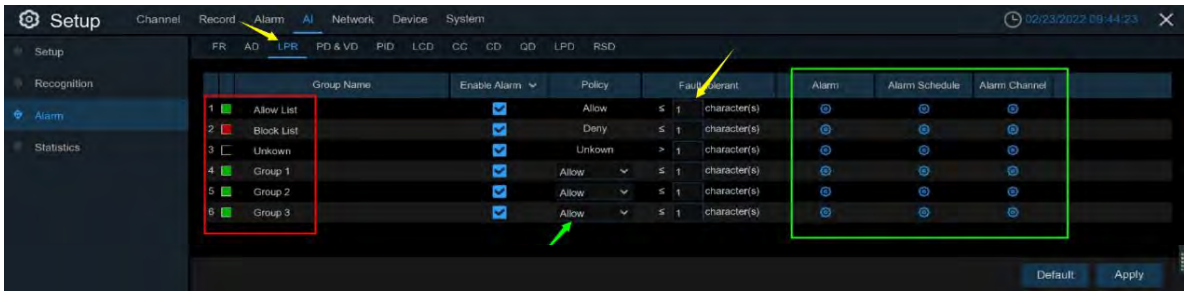

**Group Name:** Group name.

**Enable alarm:** Turn the license plate detection alarm on or off.

**Policy:** Set up the license plate group alarm countermeasures.



**Fault-tolerant:** Fault tolerance rate, if set to three characters, the white list in the group is B594SB, and an alert trigger when a B734KB enters the monitoring area. That is, the detection license plate number has 0-3 characters and the database license plate number is different will alarm.

**Alarm Channel:** Set the channel to alarm after the license plate is detected and aligned successfully.

**Alarm:** Click  to enter the setting interface.



**Buzzer (buzzer):** The DVR can use its internal buzzer to sound an alarm. Set the buzzer duration (in seconds) when triggering the license plate detection alarm.

**License Plate Capture:** License plate number picture capture.

**Save Background:** Save the background.

**Show Thumbnail:** Show the little thumbnails.

**Send Email:** When a license plate is detected, a picture is sent to the set mailbox.

**FTP Picture Upload:** When the license plate is detected, the picture is sent to the set FTP server.

**Picture to Cloud:** When the license plate is detected, the picture is sent to the set cloud storage server.

**Voice Prompts:** Voice prompt, when the alarm is triggered, a good audio file will be imported through the voice broadcast.

**Alarm Schedule:** Click  to enter the setting plan interface.

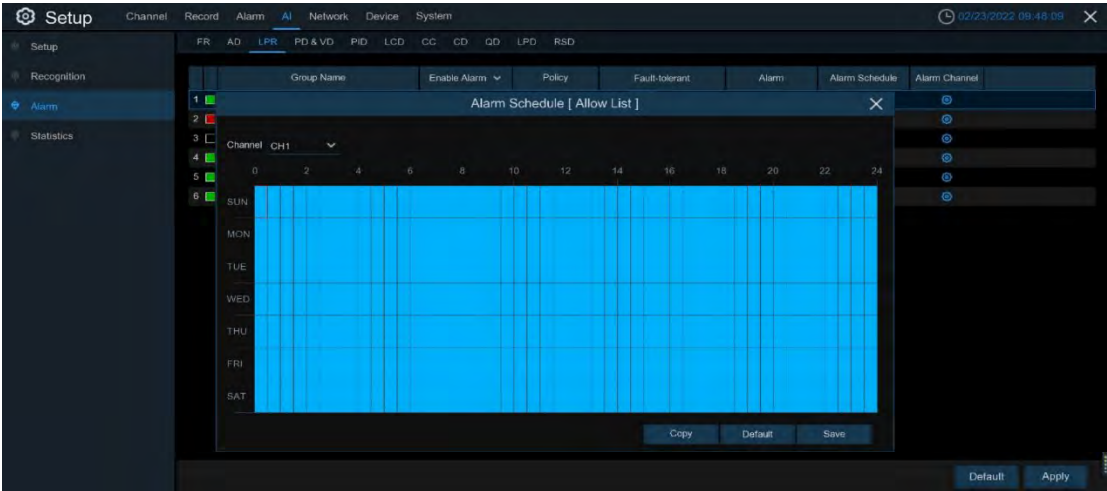

Check the time period that you want to alarm, click **Apply** to save, and click **Copy** to copy the parameters to other channels.

5.4.3.4 Pedestrian and vehicle detection

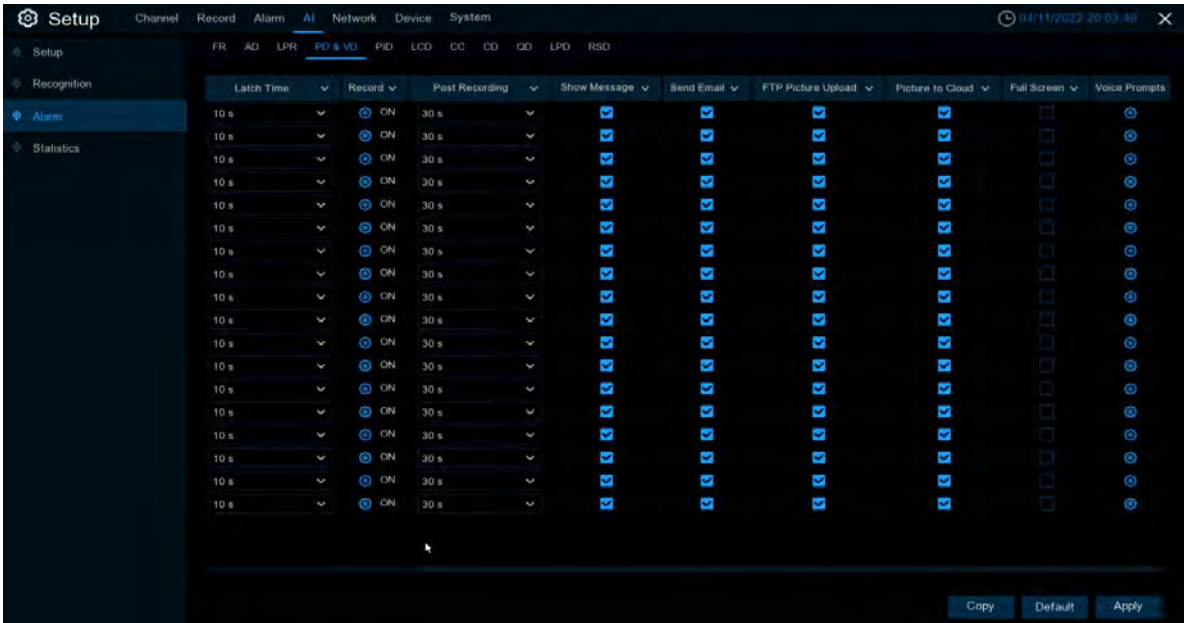
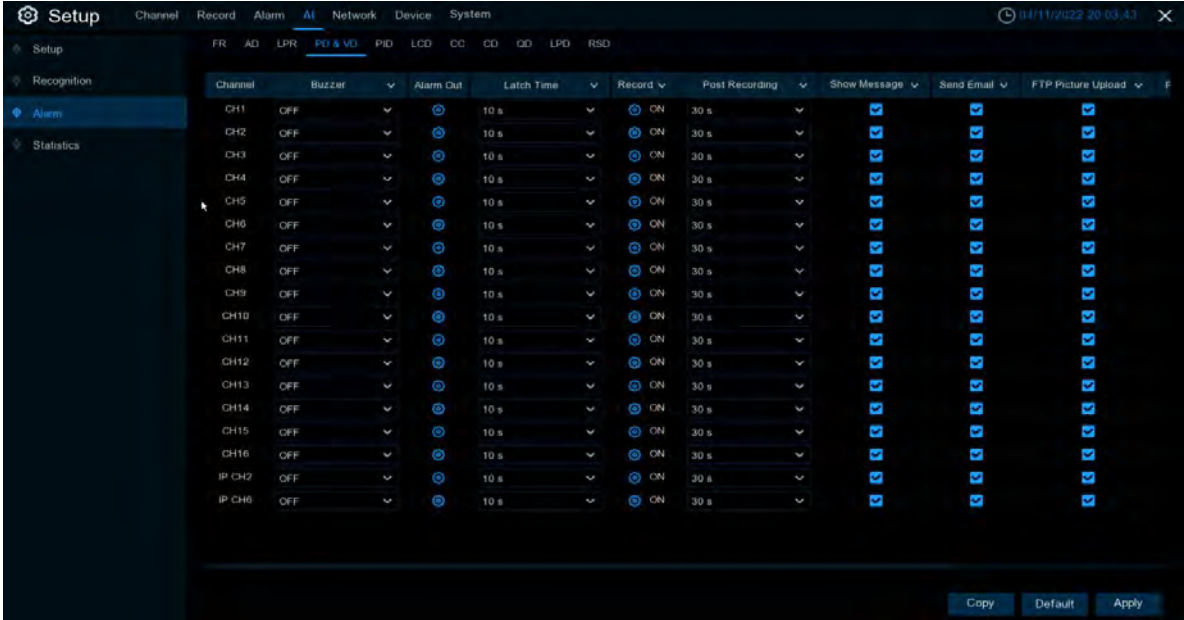

You can configure the pedestrian and vehicle alarm function here.

**Channel:** Channel Name

**Buzzer (buzzer) :**The DVR can use its internal buzzer to sound an alarm. You can set the buzzer duration (10s, 20s, 40s, 40s and 1Min).

**Alarm out (Alarm output):** Check the external alarm device when triggering pedestrian and vehicle alarms.

**Latch Time (Alarm Trigger Time):** You can set the triggering of the external alarm device in time (10s, 20s, 40s, and 1Min).

**Record (Recording):** Click the icon  and select the channel to record when triggering a pedestrian and vehicle alarm.



**Post Recording (delayed video recording):** You can set the duration of continuous DVR recording after the event occurs. The suggested recording time is 30 seconds, but can be set to up to 5 minutes.

**Show Message (Display icon):** Select this box to display the icon  on the real-time display screen when pedestrian and vehicle alarms are detected.

**Send Email (Send mail):** You can let DVR send you automatic e-mail for pedestrian and vehicle alarms.

**Full Screen (Full screen display):** If this feature is enabled and pedestrian and vehicle alarms are detected in the channel, you will see the channel in full screen mode.

**FTP Picture Upload (FTP image upload):** After triggering the alert, upload the alert picture to the FTP server. See the [5.5.4 FTP](#) for more details.

**Picture to Cloud (Cloud Storage Picture):** After an alert, upload the alert picture to the cloud storage. See [5.6.2 Cloud Storage](#) for more details.

**Voice Prompts:** Voice prompt, when the alarm is triggered, the audio file imported by voice prompt (IPC to support voice prompt function), details can be seen at [5.3.9 Voice Broadcast](#)

5.4.3.5 Pedestrian intrusion

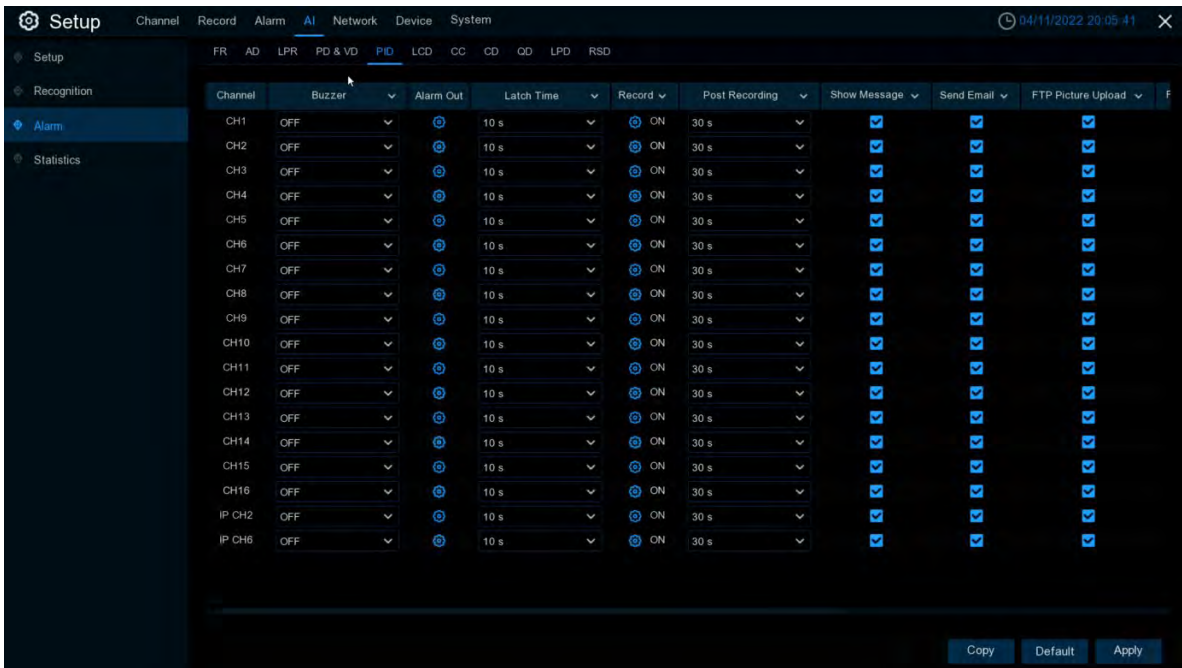



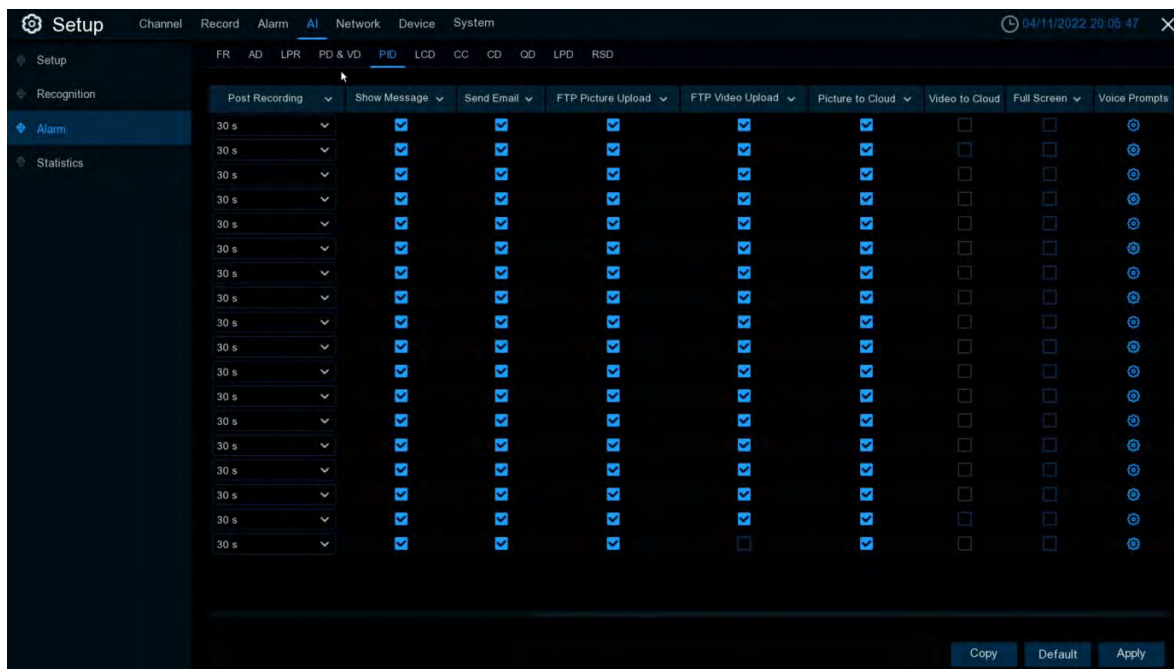

You can configure the PD function here.

**Channel:** Channel Name

**Buzzer (buzzer) :**The DVR can use its internal buzzer to sound an alarm. You can set the buzzer duration (10s, 20s, 40s, 40s and 1Min).

**Alarm out (Alarm output):** Check the external alarm device when triggering pedestrian and vehicle alarms.

**Latch Time (Alarm Trigger Time):** You can set the triggering of the external alarm device in time (10s, 20s, 40s, and 1Min).

**Record (Recording):** Click the icon  and select the channel to record when triggering a pedestrian and vehicle alarm.



**Post Recording (delayed video recording):** You can set the duration of continuous DVR recording after the event occurs. The suggested recording time is 30 seconds, but can be set to up to 5 minutes.

**Show Message (Display icon):** Select this box to display the icon  on the real-time display screen when pedestrian and vehicle alarms are detected.

**Send Email (Send mail):** You can let DVR send you automatic e-mail for pedestrian and vehicle alarms.

**Full Screen (Full screen display):** If this feature is enabled and pedestrian and vehicle alarms are detected in the channel, you will see the channel in full screen mode.

**FTP Picture Upload (FTP image upload):** After triggering the alert, upload the alert picture to the FTP server. See the [5.5.4 FTP](#) for more details.

**FTP Video Upload (FTP video upload):** After the alarm is triggered, upload the alarm video to the FTP server. See the [5.5.4 FTP](#) for more details

**Picture to Cloud (Cloud Storage Picture):** After an alert, upload the alert picture to the cloud storage. See 5.6.2 Cloud Storage for more details [5.6.2 Cloud Storage](#)

**Voice Prompts:** Voice prompt, when the alarm is triggered, the audio file imported by voice prompt (IPC to support voice prompt function), details can be seen at [5.3.9 Voice Broadcast](#)



5.4.3.6 Line Cross Detection

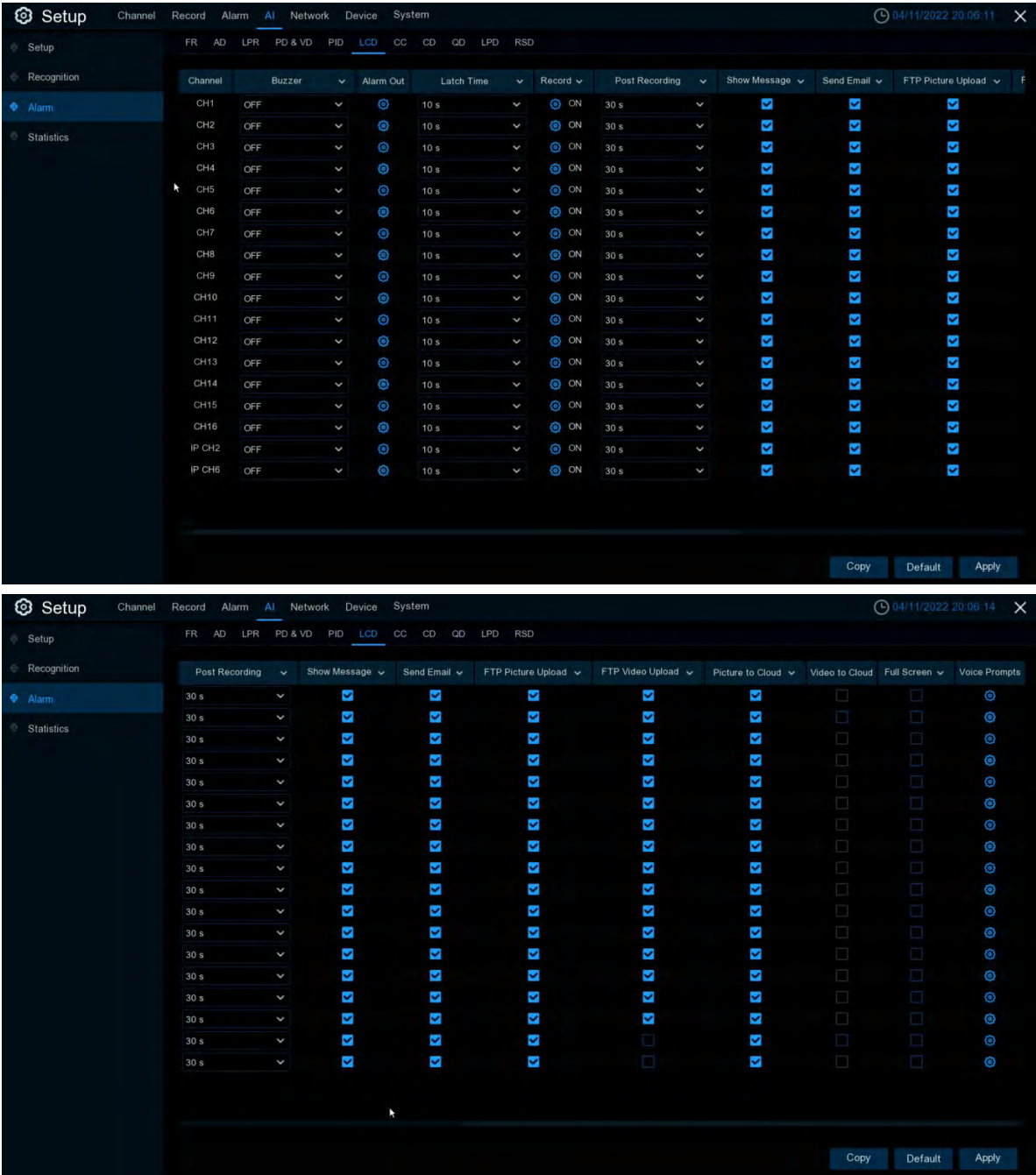

You can configure the line detection alarm function here.

**Channel:** Channel Name

**Buzzer (buzzer) :**The DVR can use its internal buzzer to sound an alarm. You can set the buzzer duration (10s, 20s, 40s, 40s and 1Min).

**Alarm out (Alarm output):** Check the external alarm device when triggering pedestrian and vehicle alarms.

**Latch Time (Alarm Trigger Time):** You can set the triggering of the external alarm device in time (10s, 20s, 40s, and 1Min).

**Record (Recording):** Click the icon and select the channel to record when triggering a pedestrian and vehicle alarm.

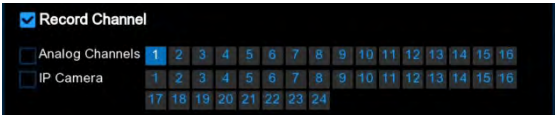

**Post Recording (delayed video recording):** You can set the duration of continuous DVR recording after the event occurs. The suggested recording time is 30 seconds, but can be set to up to 5 minutes.

**Show Message (Display icon):** Select this box to display the icon  on the real-time display screen when pedestrian and vehicle alarms are detected.

**Send Email (Send mail):** You can let DVR send you automatic e-mail for pedestrian and vehicle alarms.

**Full Screen (Full screen display):** If this feature is enabled and pedestrian and vehicle alarms are detected in the channel, you will see the channel in full screen mode.

**FTP Picture Upload (FTP image upload):** After triggering the alert, upload the alert picture to the FTP server. See the [5.5.4 FTP](#) for more details.

**FTP Video Upload (FTP video upload):** After the alarm is triggered, upload the alarm video to the FTP server. See the [5.5.4 FTP](#) for more details

**Picture to Cloud (Cloud Storage Picture):** After an alert, upload the alert picture to the cloud storage. See 5.6.2 Cloud Storage for more details [5.6.2 Cloud Storage](#)

**Voice Prompts:** Voice prompt, when the alarm is triggered, the audio file imported by voice prompt (IPC to support voice prompt function), details can be seen at [5.3.9 Voice Broadcast](#)

### 5.4.3.7 CC

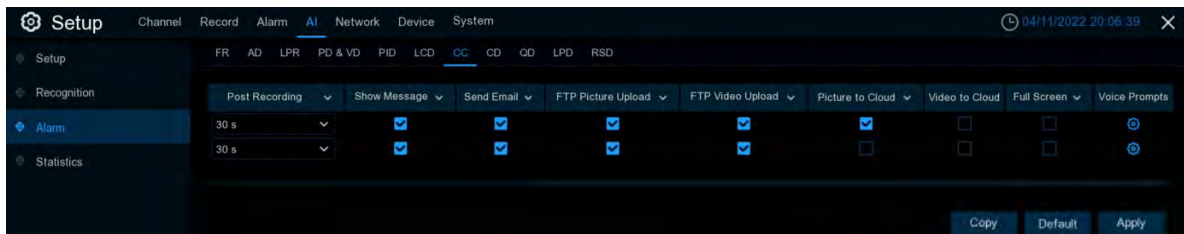
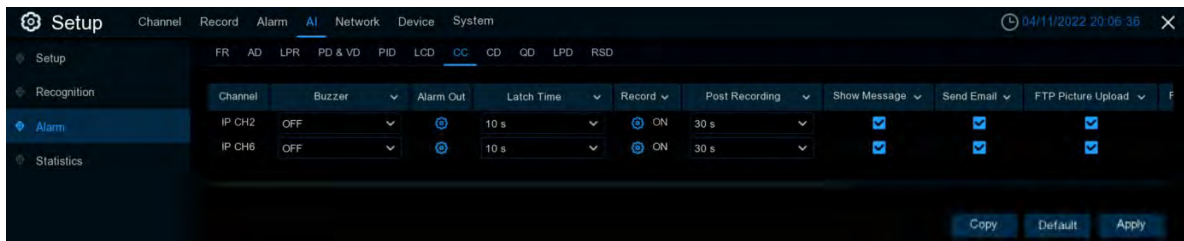

You can configure the cc function here.

**Channel:** Channel Name

**Buzzer (buzzer) :**The DVR can use its internal buzzer to sound an alarm. You can set the buzzer duration (10s, 20s, 40s, 40s and 1Min).

**Alarm out (Alarm output):** Check the external alarm device when triggering pedestrian and vehicle alarms.

**Latch Time (Alarm Trigger Time):** You can set the triggering of the external alarm device in time (10s, 20s, 40s, and 1Min).

**Record (Recording):** Click the icon  and select the channel to record when triggering a pedestrian and vehicle alarm.



**Post Recording (delayed video recording):** You can set the duration of continuous DVR recording after the event occurs. The suggested recording time is 30 seconds, but can be set to up to 5 minutes.

**Show Message (Display icon):** Select this box to display the icon  on the real-time display screen when pedestrian and vehicle alarms are detected.

**Send Email (Send mail):** You can let DVR send you automatic e-mail for pedestrian and vehicle alarms.

**Full Screen (Full screen display):** If this feature is enabled and pedestrian and vehicle alarms are detected in the channel, you will see the channel in full screen mode.

**FTP Picture Upload (FTP image upload):** After triggering the alert, upload the alert picture to the FTP server. See the [5.5.4 FTP](#) for more details.

**FTP Video Upload (FTP video upload):** After the alarm is triggered, upload the alarm video to the FTP server. See the [5.5.4 FTP](#) for more details

**Picture to Cloud (Cloud Storage Picture):** After an alert, upload the alert picture to the cloud storage. See 5.6.2 Cloud Storage for more details [5.6.2 Cloud Storage](#)

**Voice Prompts:** Voice prompt, when the alarm is triggered, the audio file imported by voice prompt (IPC to support voice prompt function), details can be seen at [5.3.9 Voice Broadcast](#)

### 5.4.3.8 CD

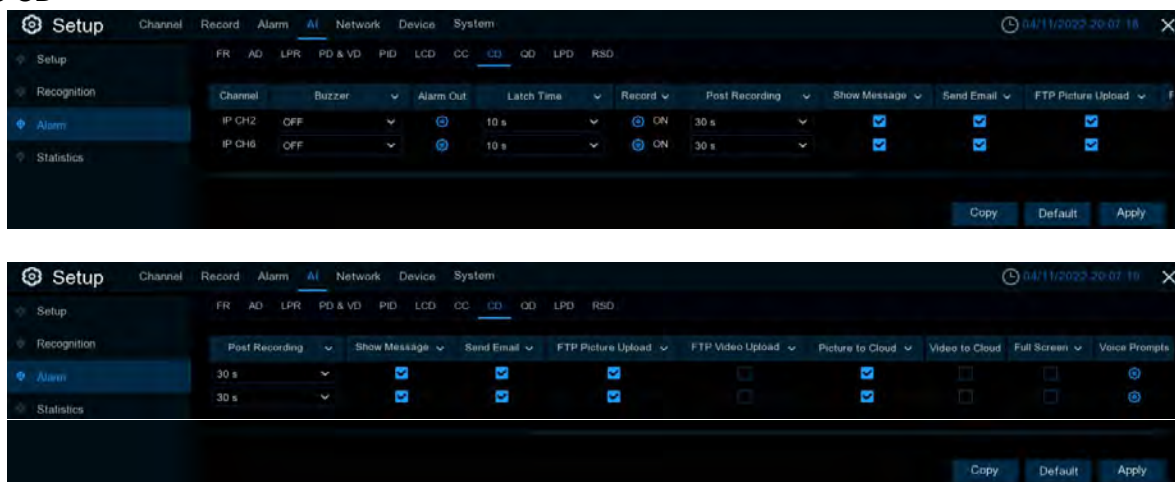

You can configure the CD function here.

**Channel:** Channel Name

**Buzzer (buzzer) :**The DVR can use its internal buzzer to sound an alarm. You can set the buzzer duration (10s, 20s, 40s, 40s and 1Min).

**Alarm out (Alarm output):** Check the external alarm device when triggering pedestrian and vehicle alarms.

**Latch Time (Alarm Trigger Time):** You can set the triggering of the external alarm device in time (10s, 20s, 40s, and 1Min).

**Record (Recording):** Click the icon  and select the channel to record when triggering a pedestrian and vehicle alarm.



**Post Recording (delayed video recording):** You can set the duration of continuous DVR recording after the event occurs. The suggested recording time is 30 seconds, but can be set to up to 5 minutes.

**Show Message (Display icon):** Select this box to display the icon  on the real-time display screen when pedestrian and vehicle alarms are detected.

**Send Email (Send mail):** You can let DVR send you automatic e-mail for pedestrian and vehicle alarms.

**Full Screen (Full screen display):** If this feature is enabled and pedestrian and vehicle alarms are detected in the channel, you will see the channel in full screen mode.

**FTP Picture Upload (FTP image upload):** After triggering the alert, upload the alert picture to the FTP server. See the [5.5.4 FTP](#) for more details.

**FTP Video Upload (FTP video upload):** After the alarm is triggered, upload the alarm video to the FTP server. See the [5.5.4 FTP](#) for more details

**Picture to Cloud (Cloud Storage Picture):** After an alert, upload the alert picture to the cloud storage. See 5.6.2 Cloud Storage for more details [5.6.2 Cloud Storage](#)

**Voice Prompts:** Voice prompt, when the alarm is triggered, the audio file imported by voice prompt (IPC to support voice prompt function), details can be seen at [5.3.9 Voice Broadcast](#)

### 5.4.3.9 QD Alarm

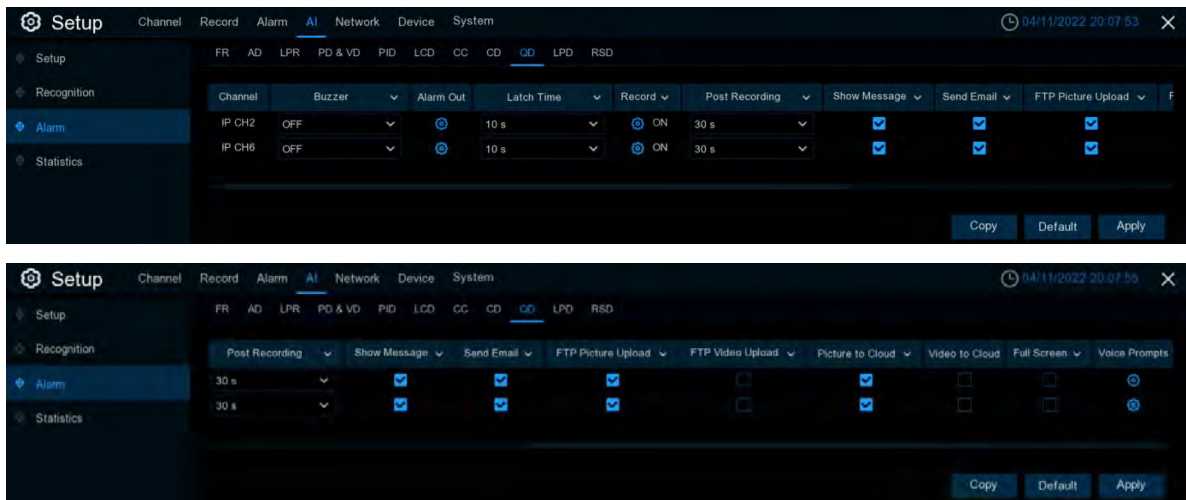

You can configure the QD alarm function here.

**Channel:** Channel Name

**Buzzer (buzzer) :**The DVR can use its internal buzzer to sound an alarm. You can set the buzzer duration (10s, 20s, 40s, 40s and 1Min).

**Alarm out (Alarm output):** Check the external alarm device when triggering pedestrian and vehicle alarms.

**Latch Time (Alarm Trigger Time):** You can set the triggering of the external alarm device in time (10s, 20s, 40s, and 1Min).

**Record (Recording):** Click the icon and select the channel to record when triggering a pedestrian and vehicle alarm.



**Post Recording (delayed video recording):** You can set the duration of continuous DVR recording after the event occurs. The suggested recording time is 30 seconds, but can be set to up to 5 minutes.

**Show Message (Display icon):** Select this box to display the icon on the real-time display screen when pedestrian and vehicle alarms are detected.

**Send Email (Send mail):** You can let DVR send you automatic e-mail for pedestrian and vehicle alarms.

**Full Screen (Full screen display):** If this feature is enabled and pedestrian and vehicle alarms are detected in the channel, you will see the channel in full screen mode.

**FTP Picture Upload (FTP image upload):** After triggering the alert, upload the alert picture to the FTP server. See the [5.5.4 FTP](#) for more details.

**FTP Video Upload (FTP video upload):** After the alarm is triggered, upload the alarm video to the FTP server. See the [5.5.4 FTP](#) for more details

**Picture to Cloud (Cloud Storage Picture):** After an alert, upload the alert picture to the cloud storage. See 5.6.2 Cloud Storage for more details [5.6.2 Cloud Storage](#)



**Voice Prompts:** Voice prompt, when the alarm is triggered, the audio file imported by voice prompt (IPC to support voice prompt function), details can be seen at [5.3.9 Voice Broadcast](#)

### 5.4.3.10 LPD

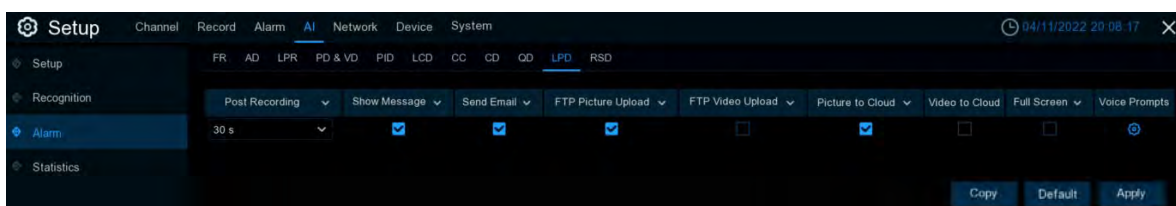
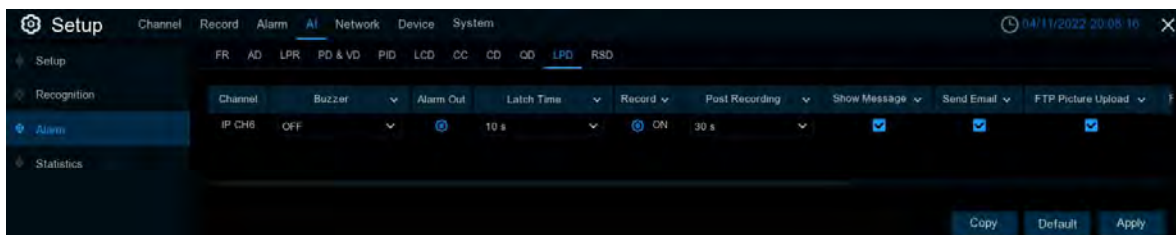

**Channel:** Channel Name

**Buzzer (buzzer) :**The DVR can use its internal buzzer to sound an alarm. You can set the buzzer duration (10s, 20s, 40s, 40s and 1Min).

**Alarm out (Alarm output):** Check the external alarm device when triggering pedestrian and vehicle alarms.

**Latch Time (Alarm Trigger Time):** You can set the triggering of the external alarm device in time (10s, 20s, 40s, and 1Min).

**Record (Recording):** Click the icon  and select the channel to record when triggering a pedestrian and vehicle alarm.



**Post Recording (delayed video recording):** You can set the duration of continuous DVR recording after the event occurs. The suggested recording time is 30 seconds, but can be set to up to 5 minutes.

**Show Message (Display icon):** Select this box to display the icon  on the real-time display screen when pedestrian and vehicle alarms are detected.

**Send Email (Send mail):** You can let DVR send you automatic e-mail for pedestrian and vehicle alarms.

**Full Screen (Full screen display):** If this feature is enabled and pedestrian and vehicle alarms are detected in the channel, you will see the channel in full screen mode.

**FTP Picture Upload (FTP image upload):** After triggering the alert, upload the alert picture to the FTP server. See the [5.5.4 FTP](#) for more details.

**FTP Video Upload (FTP video upload):** After the alarm is triggered, upload the alarm video to the FTP server. See the [5.5.4 FTP](#) for more details

**Picture to Cloud (Cloud Storage Picture):** After an alert, upload the alert picture to the cloud storage. See [5.6.2 Cloud Storage](#) for more details [5.6.2 Cloud Storage](#)

**Voice Prompts:** Voice prompt, when the alarm is triggered, the audio file imported by voice prompt (IPC to support voice prompt function), details can be seen at [5.3.9 Voice Broadcast](#)

## 5.4.3.11 RSD

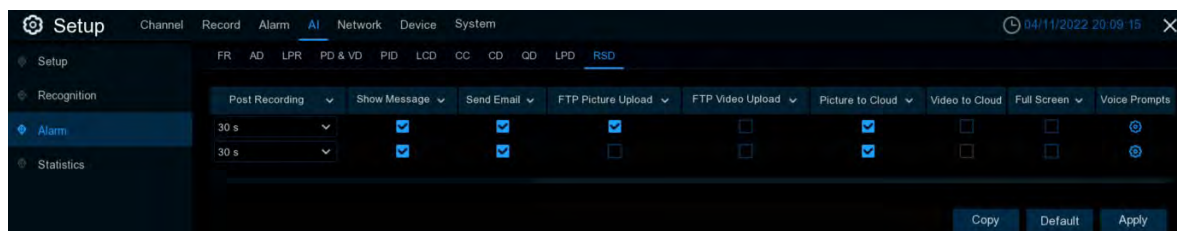
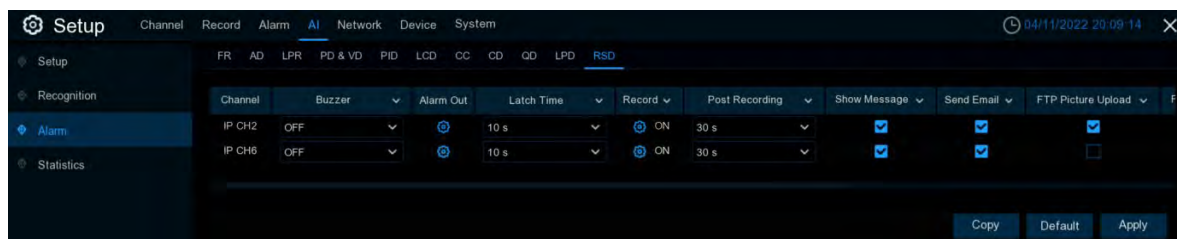

You can configure the RSD function here.

**Channel:** Channel Name

**Buzzer (buzzer):** The DVR can use its internal buzzer to sound an alarm. You can set the buzzer duration (10s, 20s, 40s, 40s and 1Min).

**Alarm out (Alarm output):** Check the external alarm device when triggering pedestrian and vehicle alarms.

**Latch Time (Alarm Trigger Time):** You can set the triggering of the external alarm device in time (10s, 20s, 40s, and 1Min).

**Record (Recording):** Click the icon  and select the channel to record when triggering a pedestrian and vehicle alarm.



**Post Recording (delayed video recording):** You can set the duration of continuous DVR recording after the event occurs. The suggested recording time is 30 seconds, but can be set to up to 5 minutes.

**Show Message (Display icon):** Select this box to display the icon  on the real-time display screen when pedestrian and vehicle alarms are detected.

**Send Email (Send mail):** You can let DVR send you automatic e-mail for pedestrian and vehicle alarms.

**Full Screen (Full screen display):** If this feature is enabled and pedestrian and vehicle alarms are detected in the channel, you will see the channel in full screen mode.

**FTP Picture Upload (FTP image upload):** After triggering the alert, upload the alert picture to the FTP server. See the [5.5.4 FTP](#) for more details.

**FTP Video Upload (FTP video upload):** After the alarm is triggered, upload the alarm video to the FTP server. See the [5.5.4 FTP](#) for more details.

**Picture to Cloud (Cloud Storage Picture):** After an alert, upload the alert picture to the cloud storage. See [5.6.2 Cloud Storage](#) for more details [5.6.2 Cloud Storage](#)

**Voice Prompts:** Voice prompt, when the alarm is triggered, the audio file imported by voice prompt (IPC to support voice prompt function), details can be seen at [5.3.9 Voice Broadcast](#)

## 5.4.4 Statistics

### 5.4.4.1 Face recognition statistics

In the face statistics, all the faces can be detected in a period of time, and reflected by statistical chart.



When **Groups**, Channels, date, and statistical time are selected, the statistical results will appear directly. Click **Export** to import the data into the U disk.

### 5.4.4.2 Pedestrian and vehicle detection statistics

In the statistics of people and cars, all the detected people and cars appearing in a period of time can be counted and reflected by statistical diagram.



After you choose the type, Channels, date, and statistical time in the Intelligent, the statistical results are then given directly.

### 5.4.4.3 CC

In the CC statistics, the number of entry and exit of a period of time can be counted, then reflected by statistical chart.

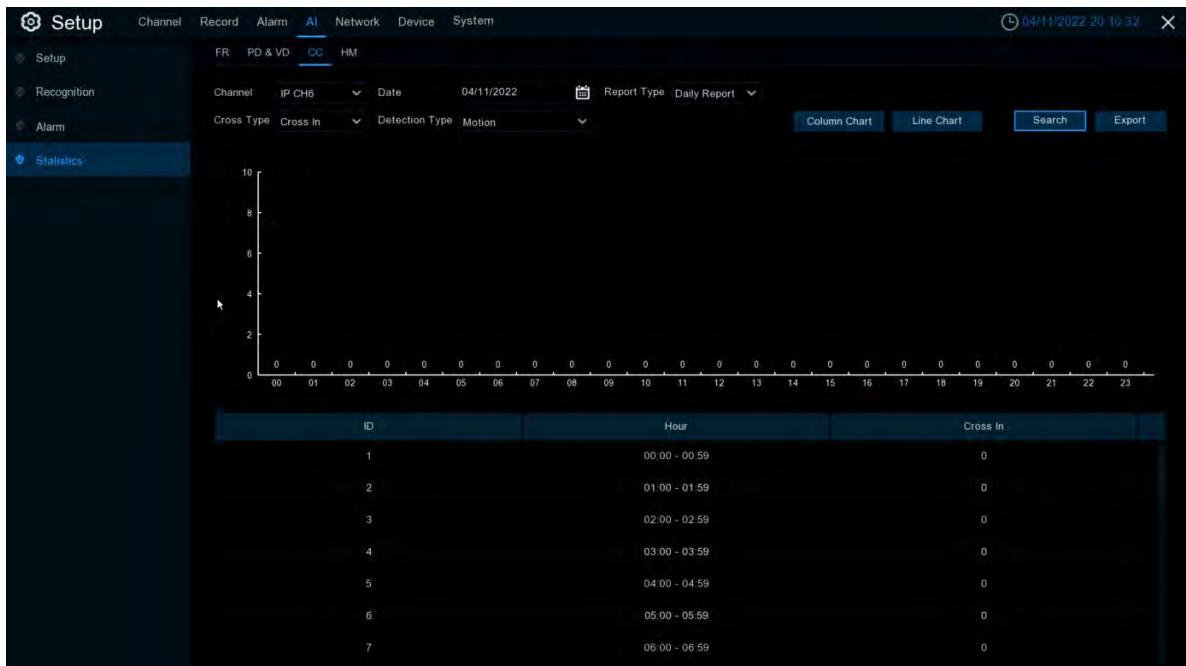

**Channel:** Select the channel that you want to search for

**Date:** Select the date that you want to search for

**Report Type:** Select the report type, with Daily Report, Weekly Report, Monthly Report, and Annual Report  
Type of report in

**Cross Type:** Crossing type, there are two types of Cross In and Cross Out

**Detection Type:** Select the detection type that triggers the CC statistics, including Motion, Person, and Vehicle

Click on the search to search for the data

**Export:** Results to export an external USB disk

Select bar graph **Column Chart** is shown as shown above

The selected bar graph **Line Chart** is shown in the following below

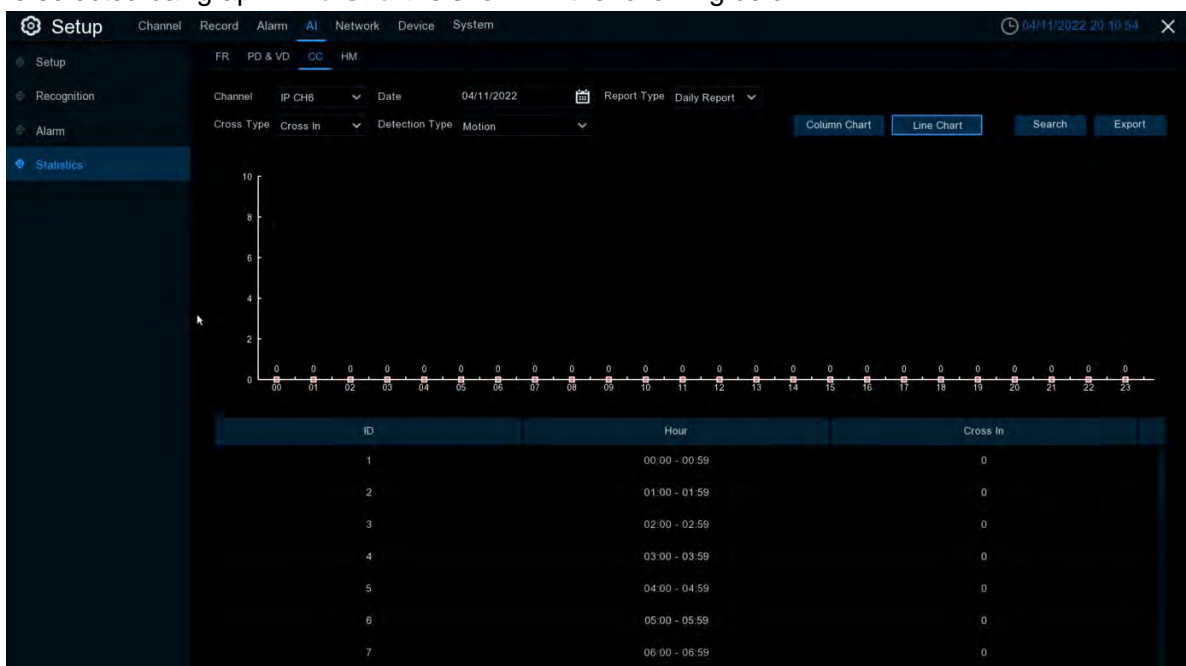



5.4.4.4 Heat map

In the heat map statistics, the frequent activity of some areas over a period of time can be counted and be reflected by a statistical chart.



- Channel:** Select the channel that you want to search for
- Date:** Select the date that you want to search for
- Start Hour:** Select the start time
- End Hour:** Select the end time
- Report Type:** Select the report type, with Daily Report, Weekly Report, Monthly Report, and Annual Report
- Type of report
- Click on the Search to **search** for the data
- Export:** Results to export an external USB disk
- Select spatial distribution map **Space Heat Map** is shown in the figure above
- Select time distribution map **Time Heat Map** is shown in the figure below
- Selection time distribution plots have no **Start Hour** and **End Hour** choices

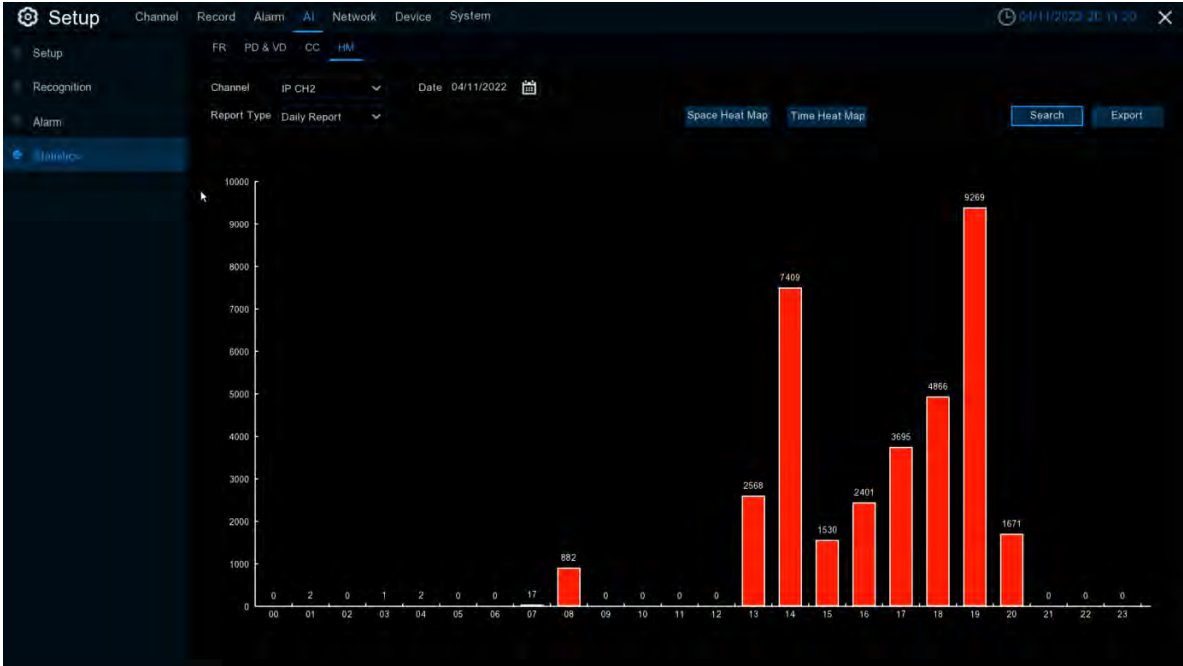

## 5.5 Network

This menu allows you to configure network parameters like PPPoE, DHCP and so on. The most common type is the DHCP. Your network type is most likely DHCP unless the network is manually addressed. If an authentication user name and password are required to access the Internet, select PPPoE.

### 5.5.1 General

#### 5.5.1.1 General configuration

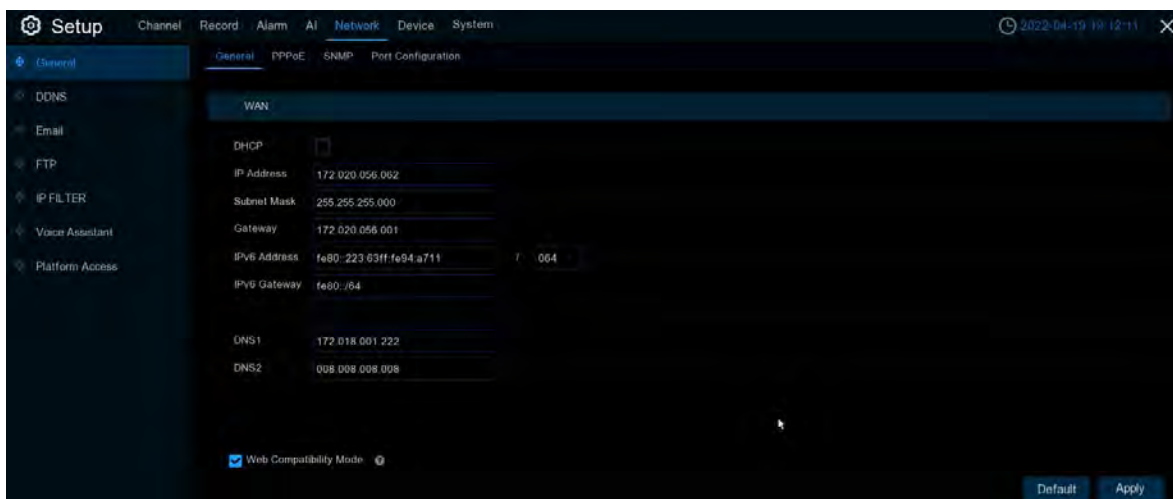

If you connect to a router that allows for DHCP s, check the DHCP box. The router automatically assigns all the network parameters to the DVR. Unless you manually set the following parameters for the network:

**IP Address:** The IP address is the identity of the DVR in the network. It consists of four groups of numbers between 0 and 255, separated by periods. For example, "192.168.001.100".

**Subnet Mask:** A Subnet mask is a network parameter that defines the IP address range that can be used in a network. If the IP address is like the street where you live, then the subnet mask is like a neighborhood. Subnet addresses also consisted of four sets of numbers, separated by periods. For example, "255.255.000.000"

**Gateway:** The gateway IP address of the network where the device is located, by default: 192.168.001.001.

**IPv6 Address:** The IPv6 address is the identity of the DVR in the network. It consists of eight sets of numbers, between 0 and FFFF, and separated by colons. For example, "ABCD: EF01:2345:6789: ABCD: EF01:2345:6789".

**DNS1 / DNS2:** DNS1 is the main DNS server, and DNS2 is the standby DNS server. Usually just enough to enter the DNS1 server address.

**Web Compatibility Mode:** After opening HTTPS, if the Win7 system computer login, you need to check this item to switch to the HTTPS page

#### 5.5.1.2 PPPo E

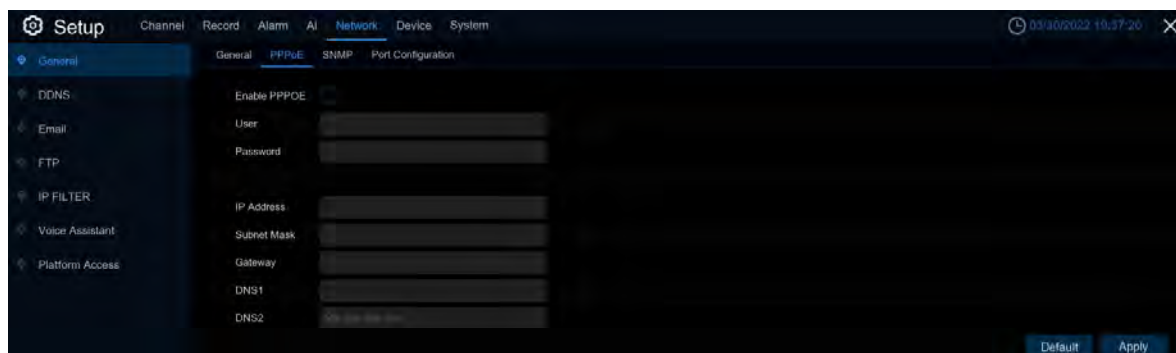

Enabling PPPoE networking will allow devices to connect to the network via dial-up Internet access.

Select the Enable PPPOE box, and then enter the user name and password for the PPPoE.

Click Apply to save, and the system will restart to activate the PPPoE settings.

### 5.5.1.3 SNMP

By configuring the SNMP (Simple Network Management Protocol) parameters, the network management side can obtain the equipment information after the network management platform connects with the equipment, which facilitates the maintenance and management of the equipment on the network management side.

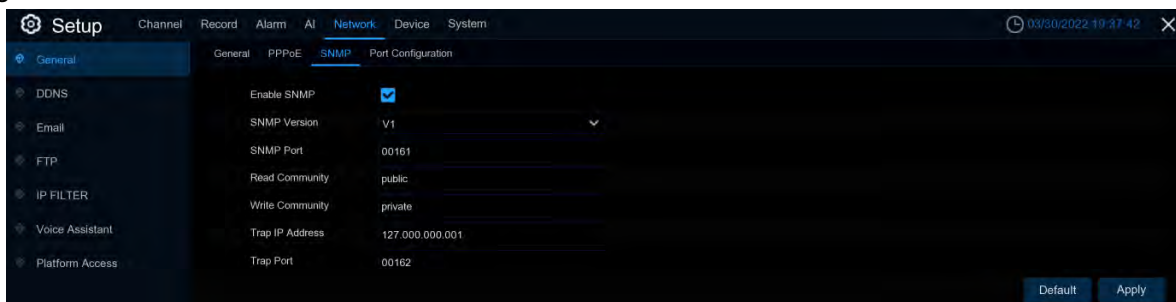

After checking Enable SNMP, part of DVR information, such as software version number, device type, channel IP, resolution, frame number, can be obtained through SNMP tool.

### 5.5.1.4 Wireless configuration

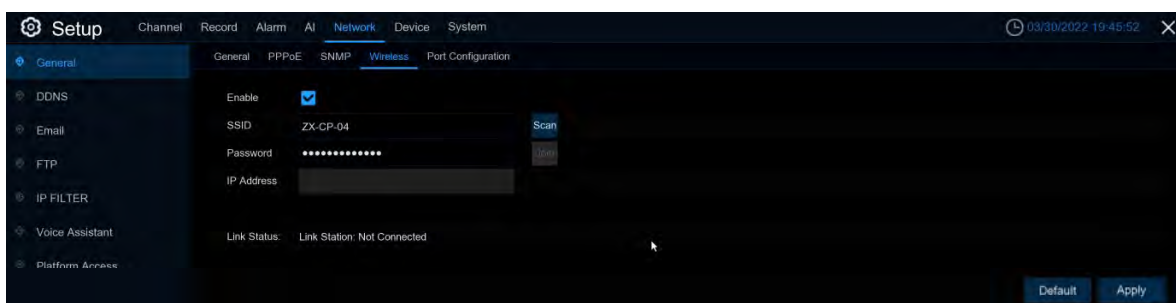

Version 8.2.2 DVR appears after accessing WiFi finger, and DVR can connect to WiFi to the Internet.

**Enable:** Wireless function enabling switch

**SSID:** WiFi name, click the Scan button to search for nearby available WiFi routes.

When the list selects the WiFi you want to connect, double-click the WiFi name you want to connect

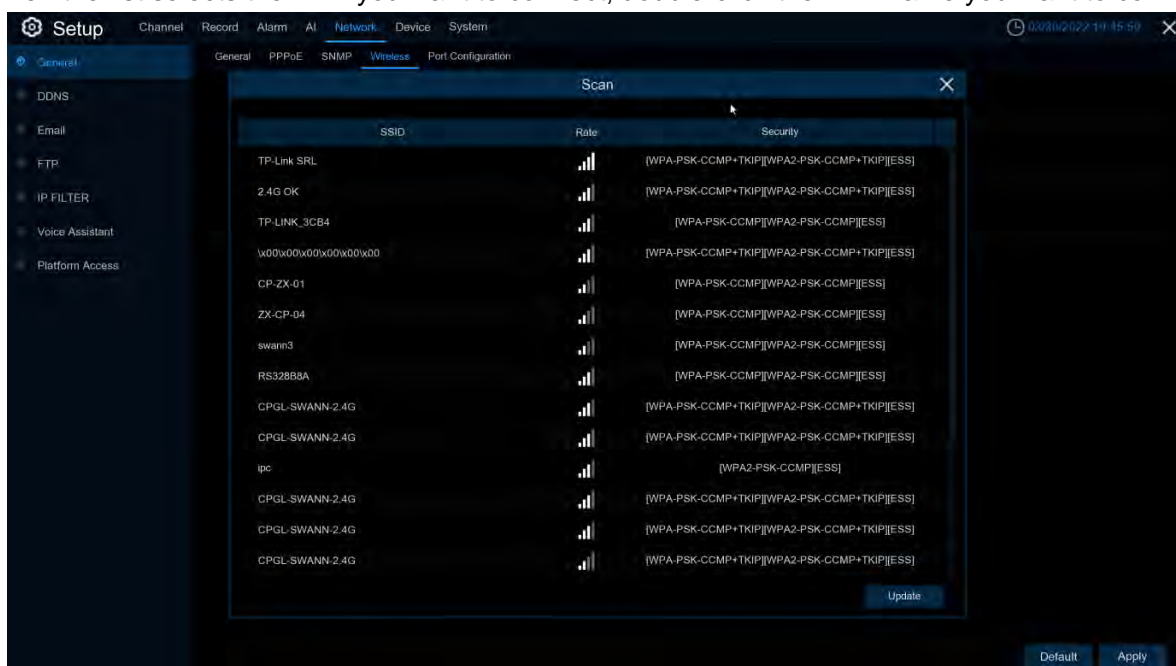

When the list selects the WiFi you want to connect, double-click the WiFi name you want to connect

**Rate:** Signal intensity.

**Security:** Security protocol information used by WiFi.

**Update:** Refresh the list.

**Password:** Password for connecting to the WiFi routing.

**IP Address:** The IP address obtained after successful connection to WiFi routing.

**Link Status:** The connection status.

**Default:** Page configuration recovery default.

**Apply:** Changes to the application configuration.

### 5.5.1.5 Port Configuration

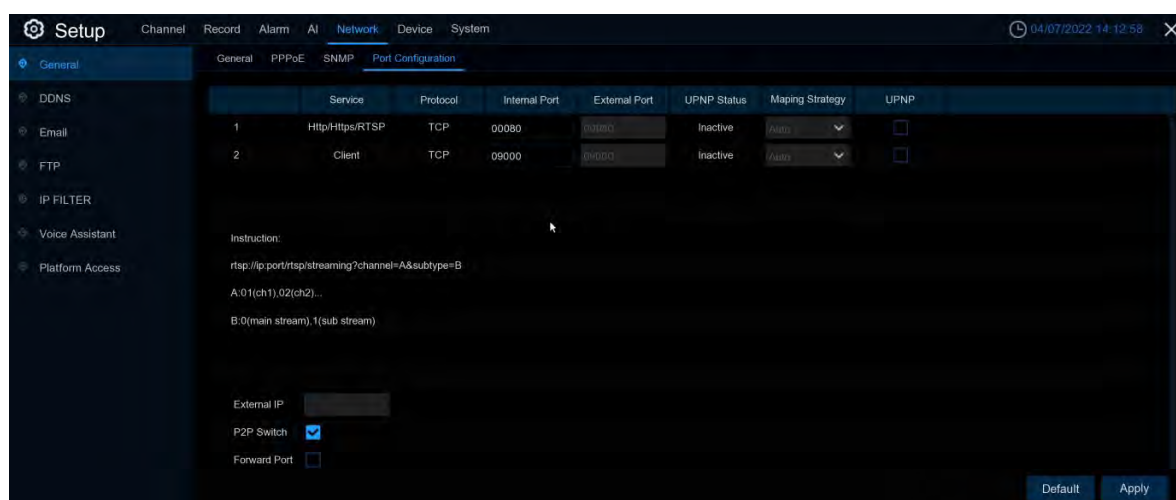

**Web Port (Web port):** This is the port you will use to log on to DVR (for example, using a Web client). Change the default port 80 if it is already occupied by another application.

**Client Port (Media Port):** This is the port that the DVR uses to send messages (for example, using mobile applications). If the default port 9000 is already used by another application, change it.

**RTSP Port (RTSP port):** This is the port where the DVR is allowed to transfer live streams to other devices (for example, using a streaming player).

**Https Port (Https port):** The Https port is a web browsing port, mainly for HTTPS services, and is another HTTP that provides encryption and transmission through a secure port.

**Note:** Version 8.2.2 combines WEB port, RTSP port, and HTTPS port with one port, and the default is 80.

**UPNP (Universal Plug and Play):** If you want to log on to the DVR remotely in a different LAN, you need to complete the port mapping in the router. Enable this option if your router supports UPnP. In this case, you do not have to manually configure the port mapping on the router. If your router does not support UPnP, make sure that the port mapping is done manually in the router.

**Mapping Strategy:** set to manually set the External Port port.

**P2P Switch:** P2P switch, closed P2P will not work.

**Forward Port:** The IPC hyperlink switch opens to access the IPC WEB page through the hyperlink on the Web end of the DVR. Currently, only available through the Web port or search, and supported API IPC can be accessed using hyperlinks.



### 5.5.2 DDNS (Dynamic Domain name server)

This menu configure DDNS settings. The DDNS provides a static address to simplify the remote connection to the DVR. To use DDNS, you first need to open an account on the DDNS service provider's DNS web page.

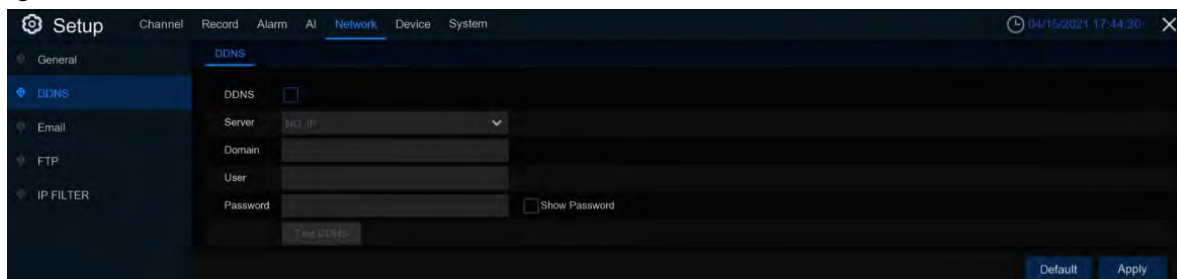

**DDNS:** Check to enable DDNS.

**Server:** Select the preferred DDNS Server (DDNS\_3322, DYNDNS, NO\_IP, CHANGEIP, DNSEXIT).

**Domain:** Enter the domain name you created on the DDNS service provider's web page. Connect to the DVR when you want to connect remotely via a PC, this is the address you type in the URL box.

**User / Password:** Enter the user name and password you get when creating an account on the DDNS provider's service web page.

After all parameters are entered, click **Test DDNS** to test the DDNS settings. If the test result is "Network is unreachable or DNS is incorrect", please check whether the network works fine, or the DDNS information is correct or not.

When the user applies for dynamic domain name service, you can use the browser to remotely access DVR through the domain name, domain name form `http://domain name:mapped Web port number`, when using DDNS domain name to access DVR, need to confirm that the port and the current IP can be normally connected on the public network, the server address / host name / user name / password / setting is consistent with the DVR setting.

### 5.5.3 Email

This menu allows you to configure email settings. Please complete these settings if you want to receive the system notifications on your email when an alarm is triggered, HDD becomes full, HDD is in error state, or Video Loss occurs.

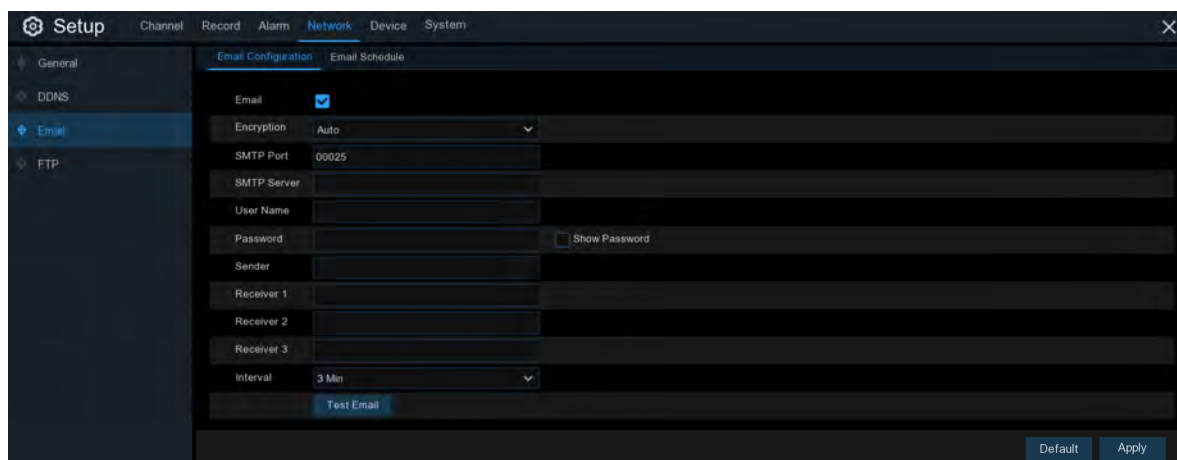

5.5.3.1 Email Configuration

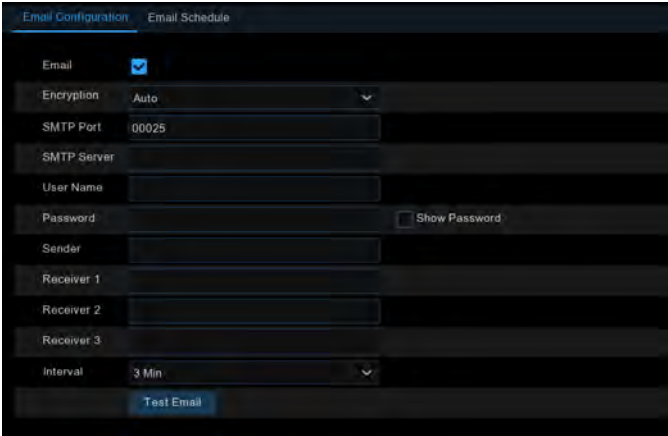

- Email:** Check to enable.
  - Encryption:** Enable if your email server requires the SSL or TLS verification. If you are not sure, set to be **Auto**.
  - SMTP Port:** Enter the SMTP port of your email server.
  - SMTP Server:** Enter the SMTP server address of your email.
  - User Name:** Enter your email address.
  - Password:** Enter the password of your email.
  - Receiver 1~3:** Enter the email address where you want to receive the event notifications from the DVR.
  - Interval:** Configure the length of the time interval between the notification emails from the DVR.
- To make sure all settings are correct, click **Test Email**. The system sends an automated email message to your inbox. If you received the test email, it means the configuration parameters are correct.

5.5.3.2 Email Schedule

You need to configure the schedule to fully implement the Email notification.



- The color codes on email schedule have the following meanings:
- Motion:** Green area
  - IO:** Yellow Area
  - Exception:** Red area
  - In-Analysis:** Blue Area
  - PIR:** Purple area

### 5.5.4 FTP

This menu allows you to enable FTP function to view and load captured snapshots from DVR to your storage device over FTP.

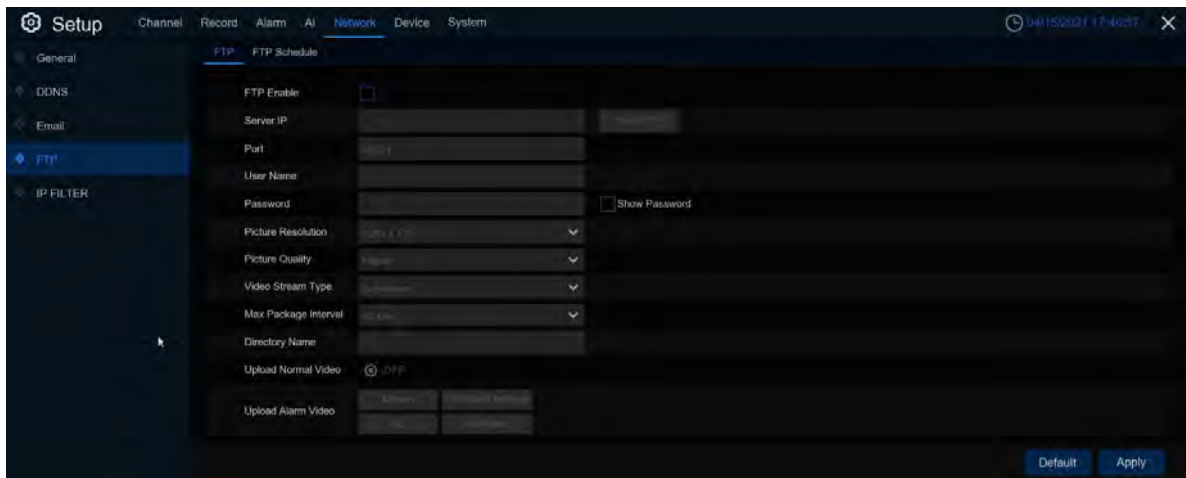

**FTP Enable:** Click to enable FTP function.

**Server IP:** Enter your FTP server IP address or domain name.

**Port:** Enter the FTP port for file exchanges.

**Name/ Password:** Enter your FTP server user name and password.

**Picture Resolution:** Set the resolution of the image uploaded to FTP

**Picture Quality:** Set the quality of the image uploaded to FTP

**Video Stream Type:** Set the video stream type uploaded to FTP, mainstream and substream for optional.

**Max Package Interval:** Set the Max Package Interval of video.

**Directory Name:** Enter the default directory name for the FTP file exchanges.

**Upload Normal Video:** Switch to Upload common videos to FTP.

**Upload Alarm Video:** Set the warning type for uploading videos to FTP. Click the option to enter the warning menu within the corresponding Alarm type.

**Test FTP:** Click to test the FTP settings



**FTP Schedule:** Need to configure the plan to perform FTP file uploading.

The color codes on email schedule have the following meanings:

**Normal:** Green area (default not selected)

**Motion:** Green area

**IO:** Yellow Area

**PIR:** Purple area

**In-Analysis:** The blue area

### 5.5.5 IP Filter

This function allows you to set a blacklist and whitelist so that only the IP addresses in the whitelist can connect to the device.

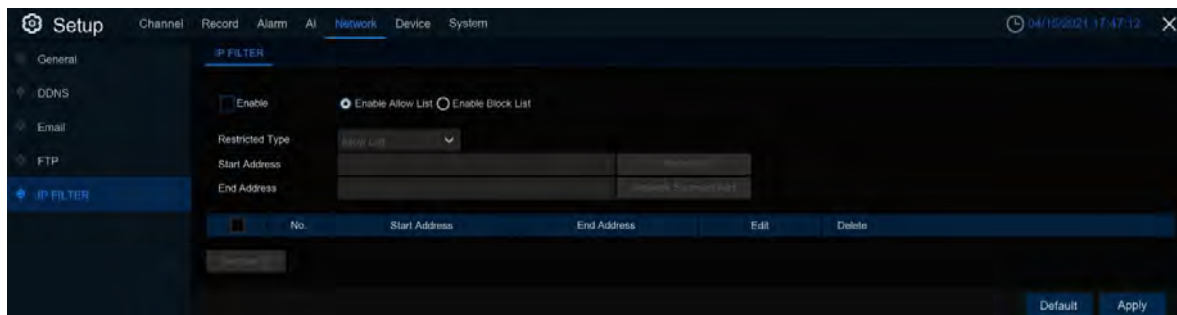

**Enable:** Enable or Disable the IP filter function. Can use the blacklist or whitelist once enabled.

**Restricted Type:** Select the list (blacklist or whitelist) to set.

**Start Address:** Input the **Start Address**.

**End Address:** Input the **End Address**.

### 5.5.6 Voice Assistant

The voice assistant feature allows connecting the DVR to the Google cast or Amazon FireTV Stick and having projected real-time monitoring images onto a TV monitor via voice control.

#### 5.5.6.1 Amazon

1. Enter your Amazon account and click the **Bind** button to connect to bind your Amazon account. Select the video code stream that you want to play to the TV monitor.

(graph)

2. Go to the Channel Live Channel menu and give a channel name that can easily call the channel to be played on a TV monitor.

(graph)

3. Connect the Fire TV Stick to the TV monitor and turn the power on. Connect the Fire TV Stick to a Wi-Fi located within the same LAN as the DVR.

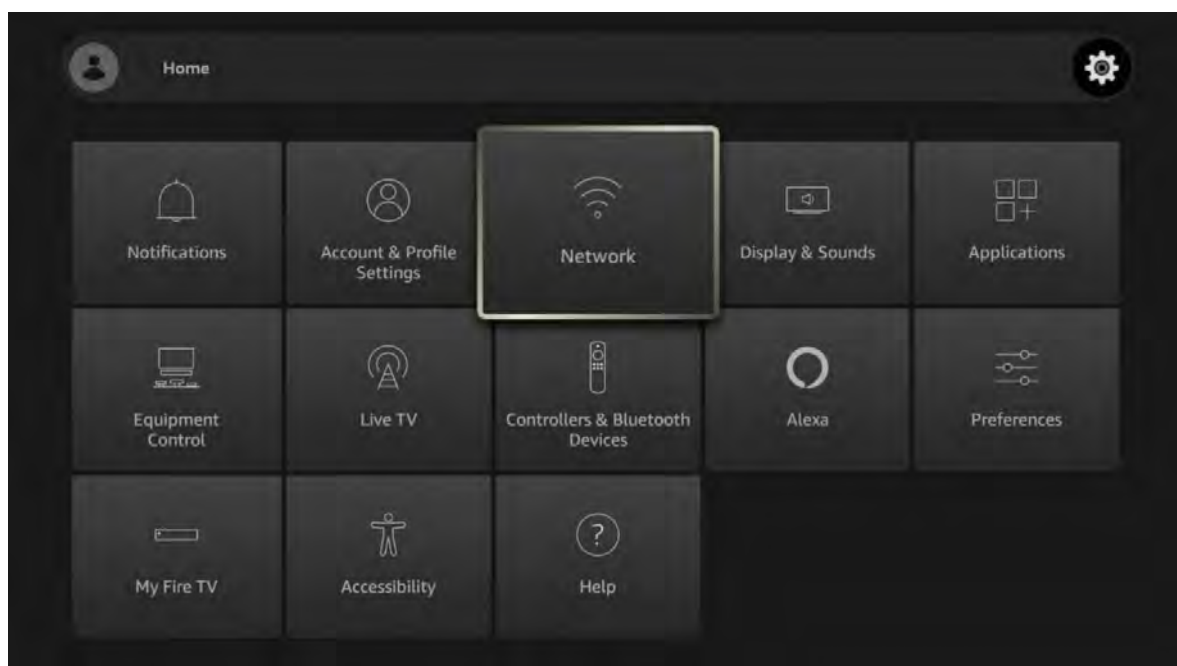



4. Use an existing profile or add a new profile, and log in to the same Amazon account that you bind to a DVR.

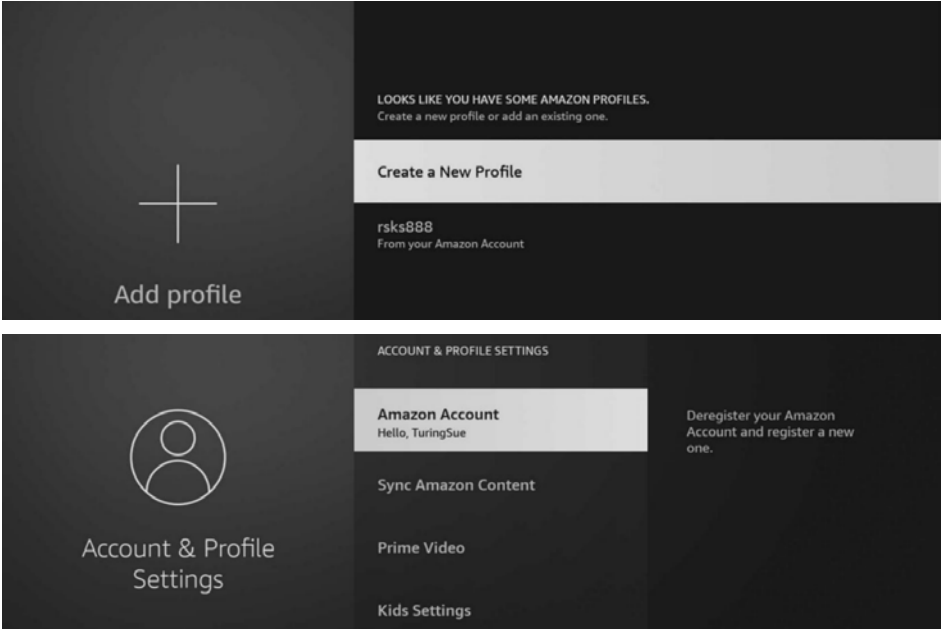

5. Search from app store and install Amazon Alexa to your phone, and log in with the same Amazon account

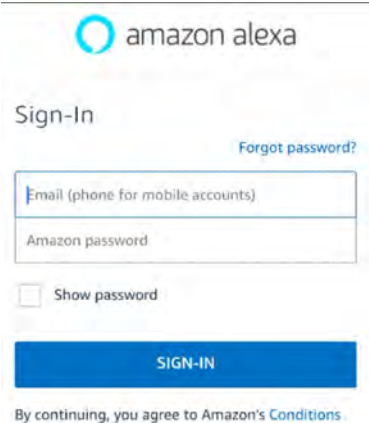

6. Click More, and then click Skills and Games.

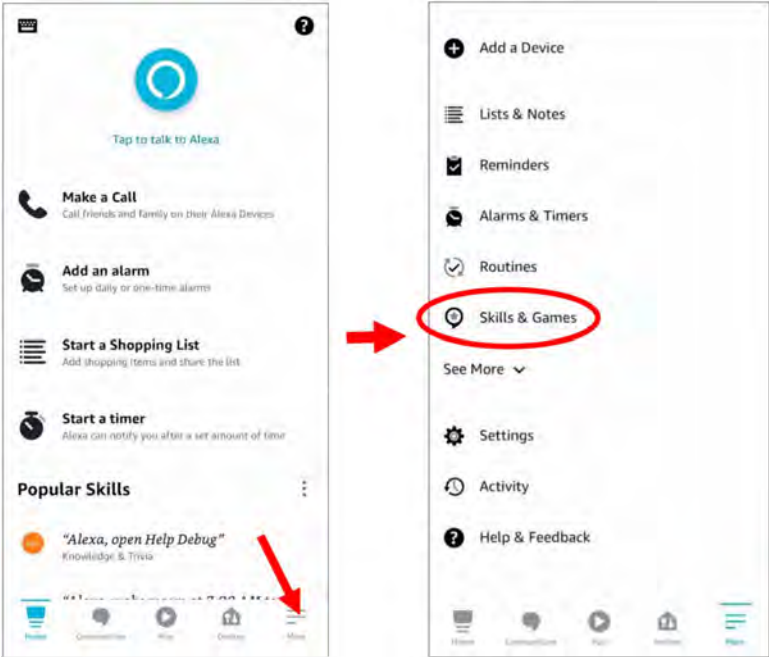

7. Click on the search icon in the top right corner.

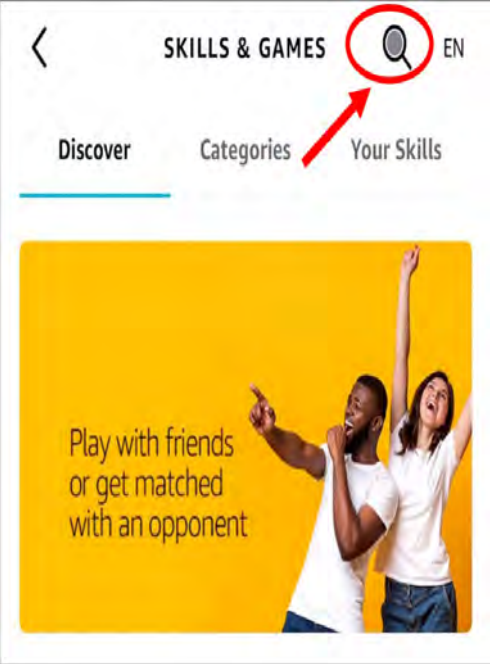

8. Enter the keyword: Smart Camera View, and search.

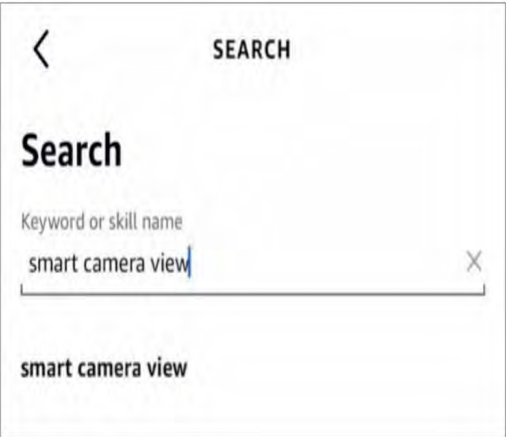

Click "Smart Camera View" to enter the search results list.

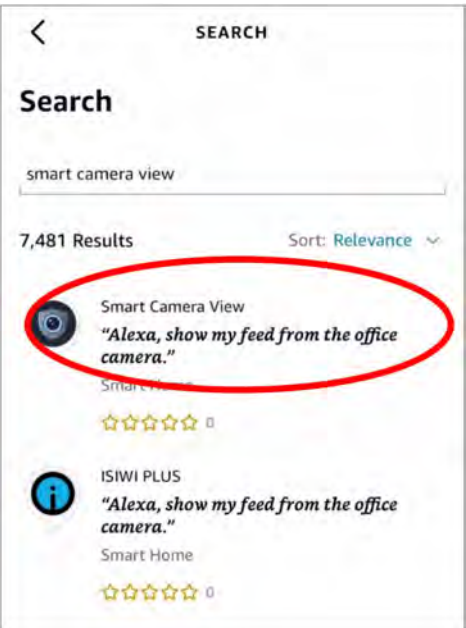

Click "ENABLE TO USE"



9. You need to link to your Amazon account. Log in to the same Amazon account as you bind to the DVR. Click "Complete" after the successful function link.

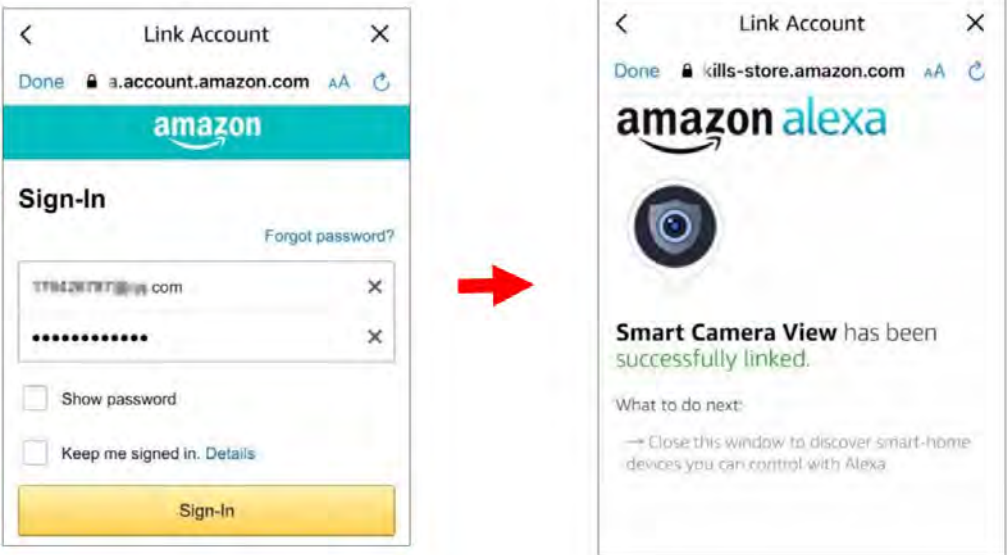

10. Click on "DISCOVER DEVICES" to wait for the app to search for the camera. After finding and connecting the device, click on Next.

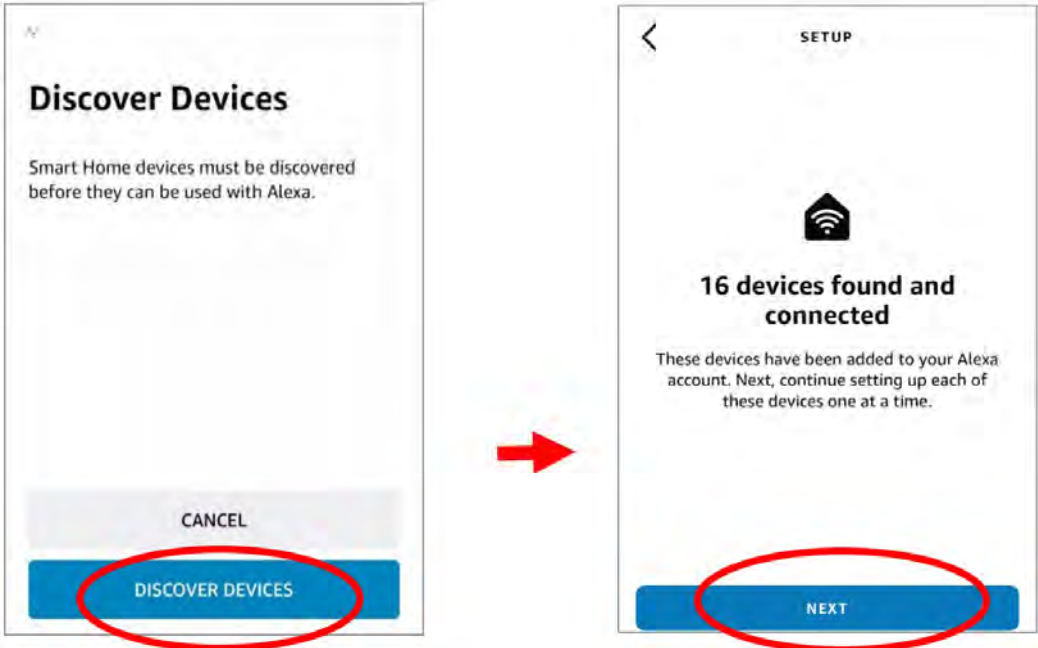

11. Select one of the devices, and then click on **SET UP DEVICE**. You can add an IPC to the group or skip it.

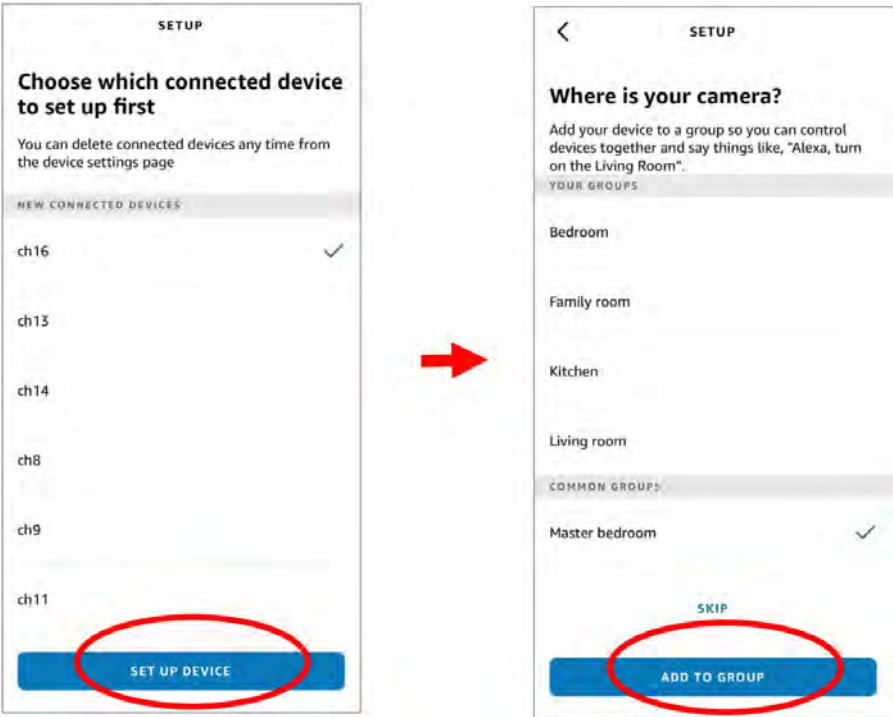

12 Repeat 11, add all cameras, and click **Done** to finish.





13. All added cameras are listed in the **Devices**. Click on the camera icon to view all of the added cameras.

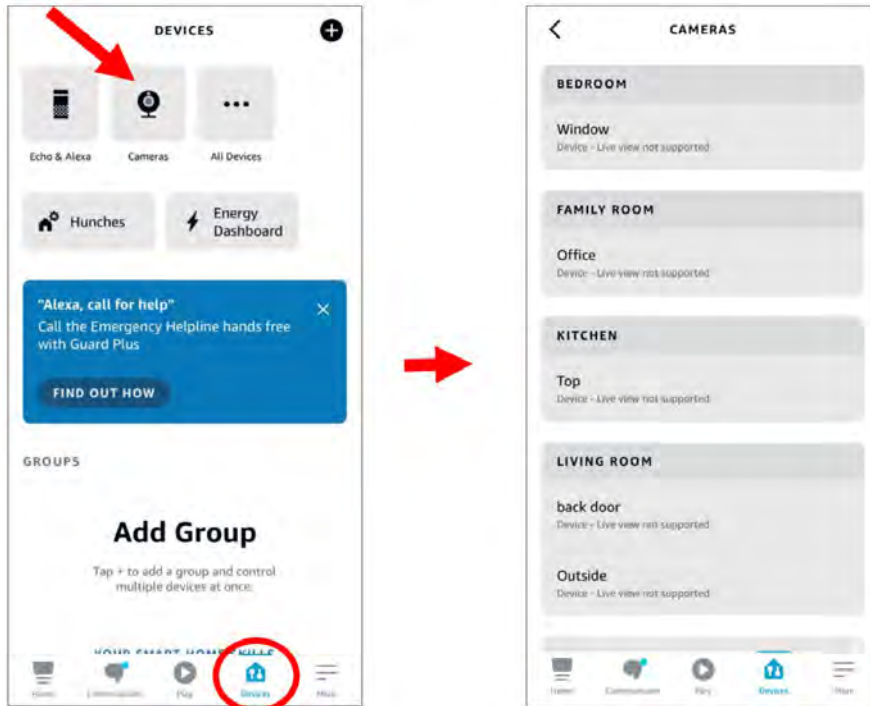

14. Press the voice button on the fire TV stick remote control and say the command clearly. This command may be similar to: Show The XXX camera / Show XXX. The XXX is the video camera channel name. For example, if the channel is named "Office", say the "Show the Office camera".

15. Wait a while to see real-time images from the office camera in the TV monitor.

16. If you want to quit the live camera, say " Stop".

17. If you change the channel name, you need to find and add the camera again.

### 5.5.6.2 Google

1. Enter your Amazon account and click the **Bind** button to connect to bind your Amazon account. Select the video code stream that you want to play to the TV monitor.

(graph)

2. Go to the Channel Live Channel menu and give a channel name that can easily call the channel to be played on a TV monitor.

(graph)

3. Connect the Chromecast to your TV monitor and turn power turned on.

4. Search from the app store and install the Google Home app to your phone. Run the installed Google Home application, click OK to allow the application to use your local network and Bluetooth, and then click on Start.

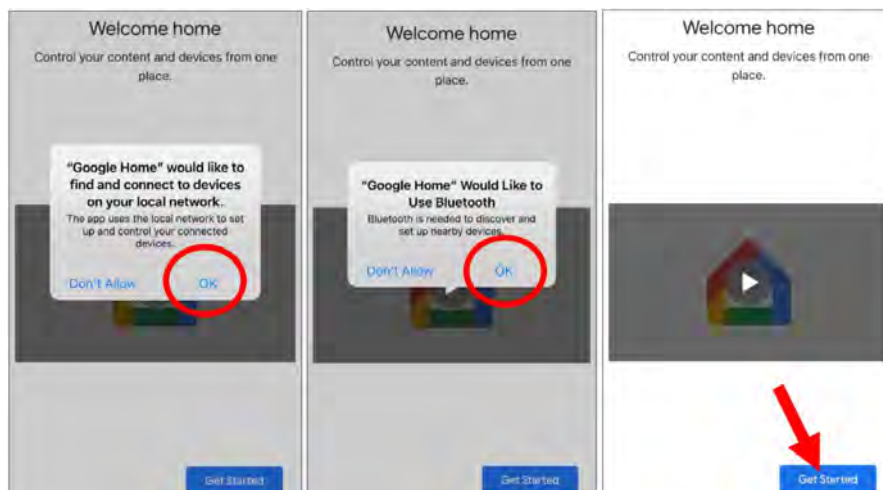

- 5. Log in to the Google account that you have bound on your DVR.
- 6. Click "Get Started" (Start) to create a home, and then click "New devices" (new device).



Enter your home nickname and address, and then touch "Next."

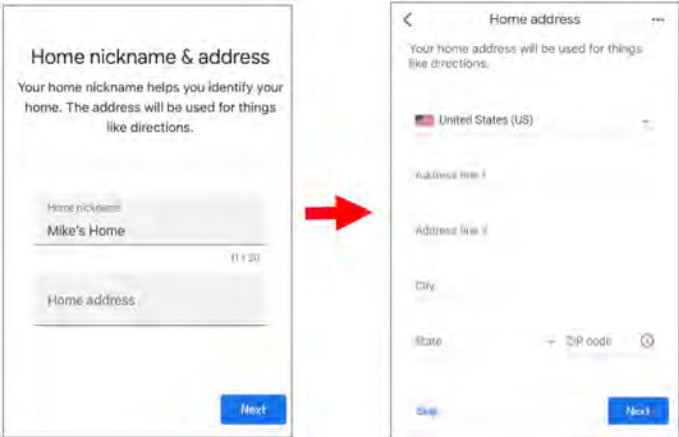

Allows location access to applications.

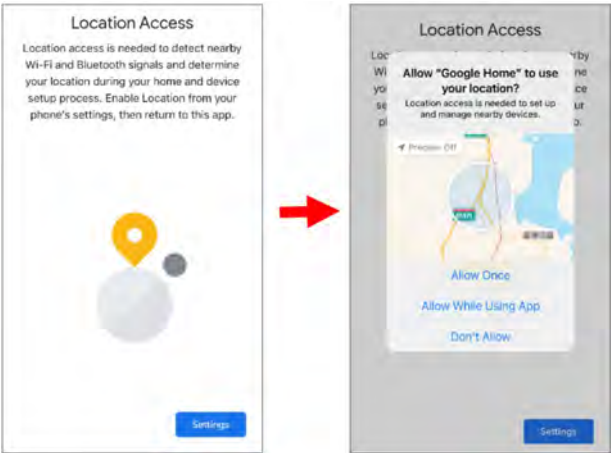

7. The application will automatically try to search the device from your local network. Choose from Chromecast / Google TV. Make sure that the Chromecast is on, and then touch the next step.

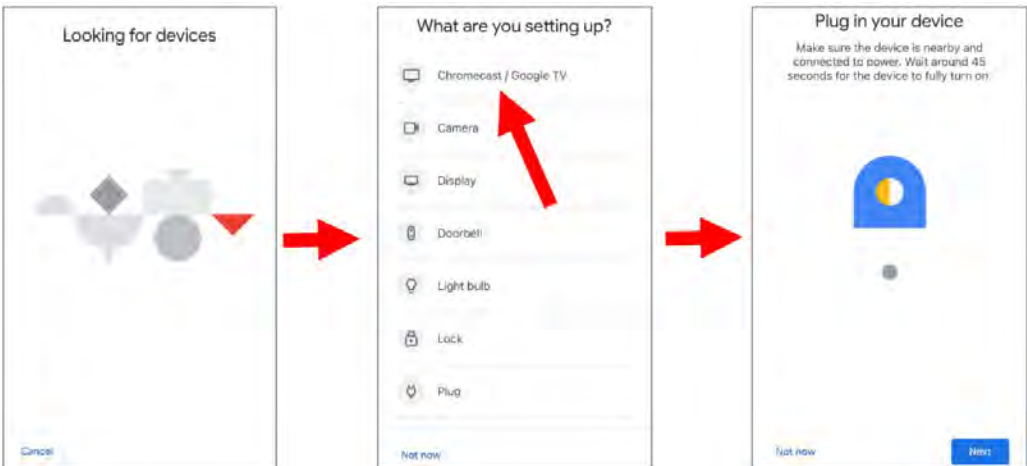

8. Your Chromecast will be found. Click on the Next to connect it. Click on Yes to confirm the code.

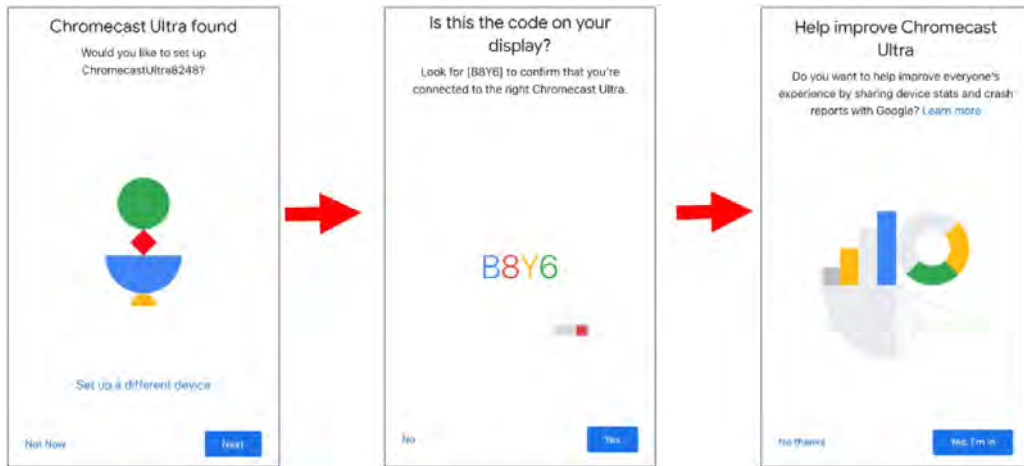

9. Select the location of the Chromecast and click Next.



10. Select the Wi-Fi network for the Chromecast and enter the Wi-Fi password to connect. Make sure that your Wi-Fi choice is the same as the phone and is in the same local network as the DVR. Click on Continue to the next step.

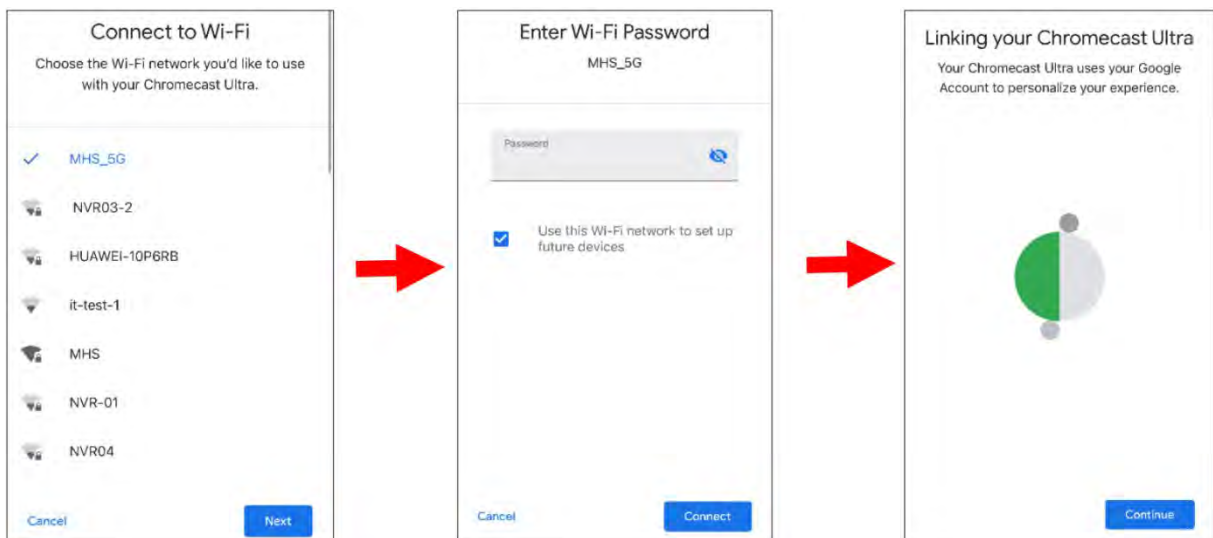

11. Click on No Thanks or Sign Up to login to your Google account.



Click Next->Skip->Finish Tutorial

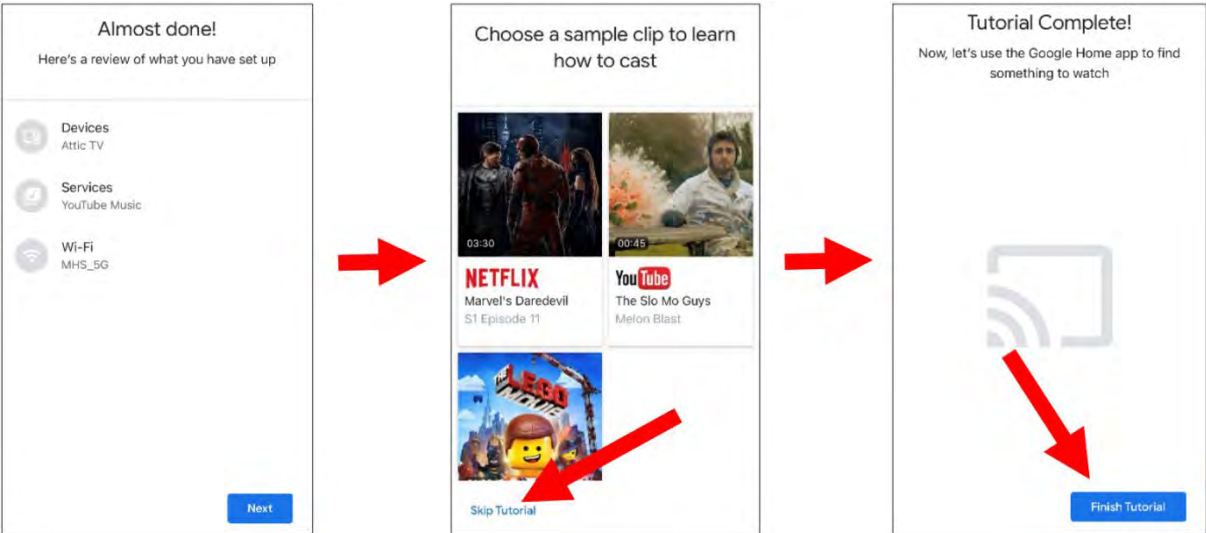

12. The Chromecast has now been added to your Google home page. Click on the + icon in the upper left corner. Indoor, and then select Setup Device.

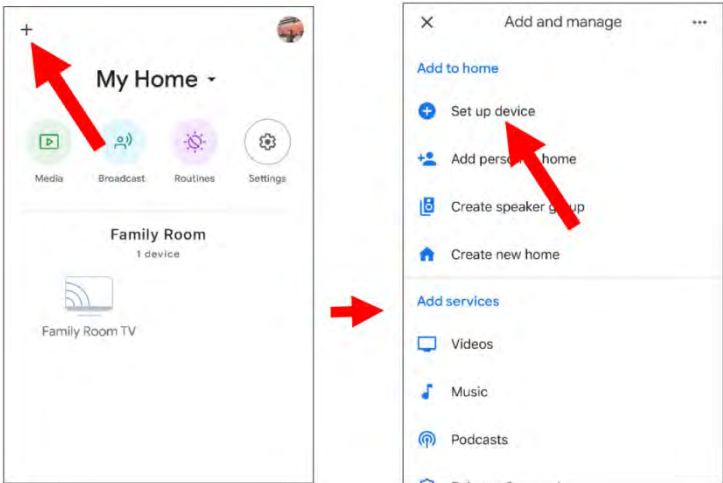



Select "Work with Google," click on the search icon in the top right corner, and enter "smart camera view."

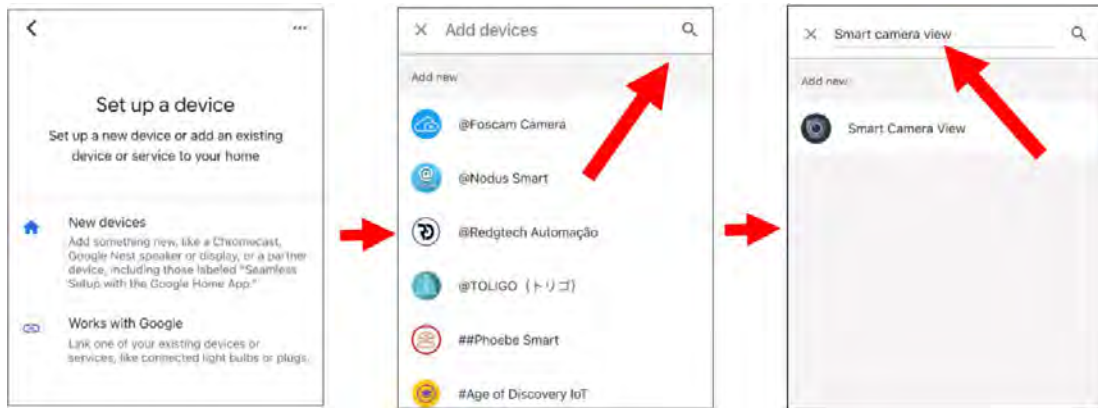

Click on "smart camera view" in the search results. You will need to log in to your Google account and allow Google access to your device.

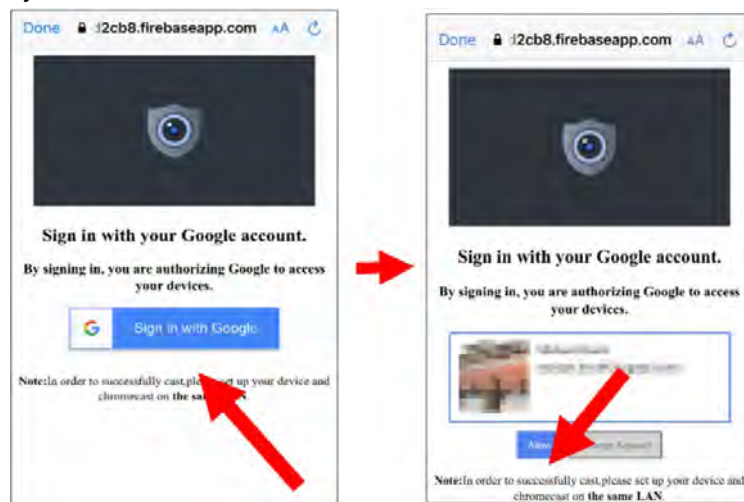

Wait a while and the app will connect to Google home.

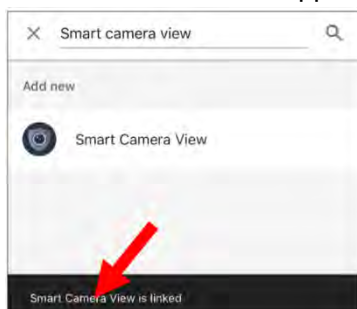

13. The cameras available in the DVR will now be displayed. Select one of the cameras, and then touch the Next button. Step by a step and select a home and location for the camera.

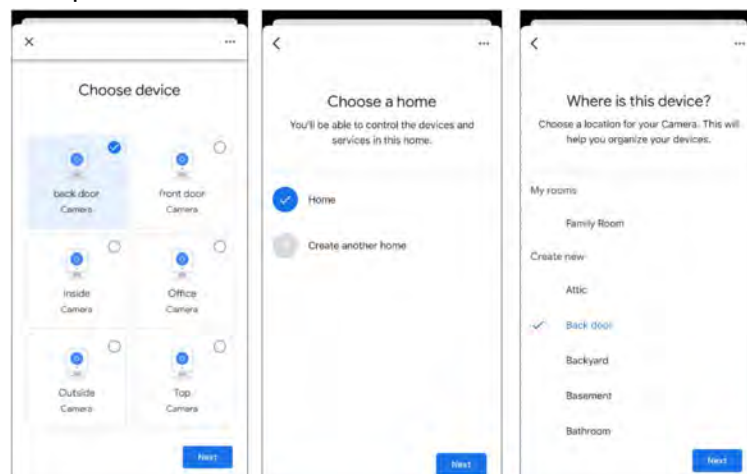

14.Repeat step 13 to add all the cameras.

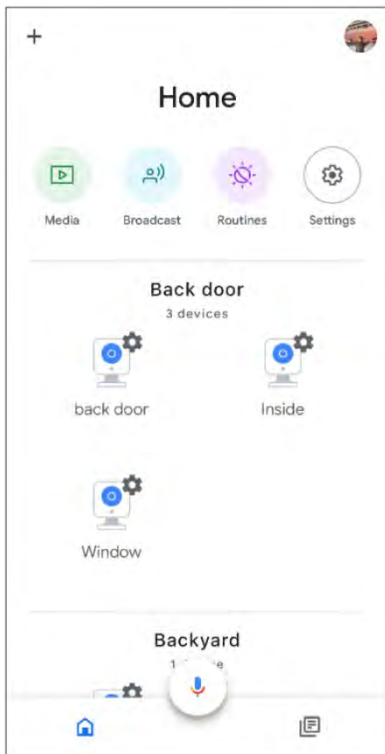

15. Search from the app store and install the Google Assistant app to your phone.

16. Run Google Assistant and log in to your Google account that is the same as you bind to DVR.

17. You can now use text or voice commands to transfer the camera to a TV monitor such as "Show / Play \* \* \* camera on XXX TV" where \* \* \* is the channel name of the camera and XXX is your TV name.

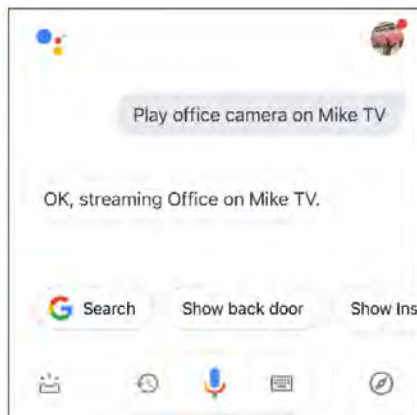

## 5.5.7 Platform Access

### 5.5.7.1 Onvif

Turning on this feature will allow devices to be searched for and added by other third-party platforms through the ONVIF protocol.

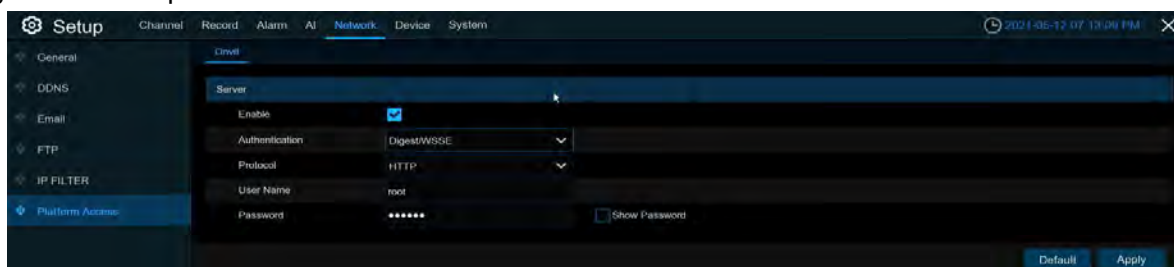

**Enable:** enable switch, turn on the service function, off whether search or add will fail

**Authentication:** login authentication methods, authentication methods are Digest\_sha256, Digest, Digest / WSSE, WSSE four kinds

**Protocol:** Connection protocol

**Username:** Login user name

**Password:** Login user password

**Note:** The pictures connected by the back end through ONVIF protocol are all the pictures of the first channel

## 5.6 Device

In this section, you can configure the internal HDD & Cloud storage function.

### 5.6.1 Disk

This menu allows you to check & configure the internal HDD(s). You need to format the HDD only at the first startup and if you replace a new HDD.

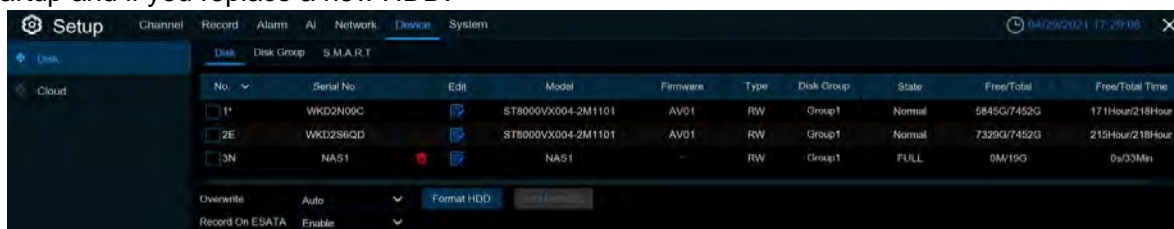

**Format HDD:** Select the HDD you want to format and then click **Format HDD**. To start formatting, you need to enter your user name and password and then click **OK** to confirm to continue formatting.

**ADD NetHDD:** You can use this function to ADD network disks. After a network hard disk (NAS) is configured, you can connect the NAS to the network to record channel videos or capture pictures. But the AI face database can only be saved on the hard disk.

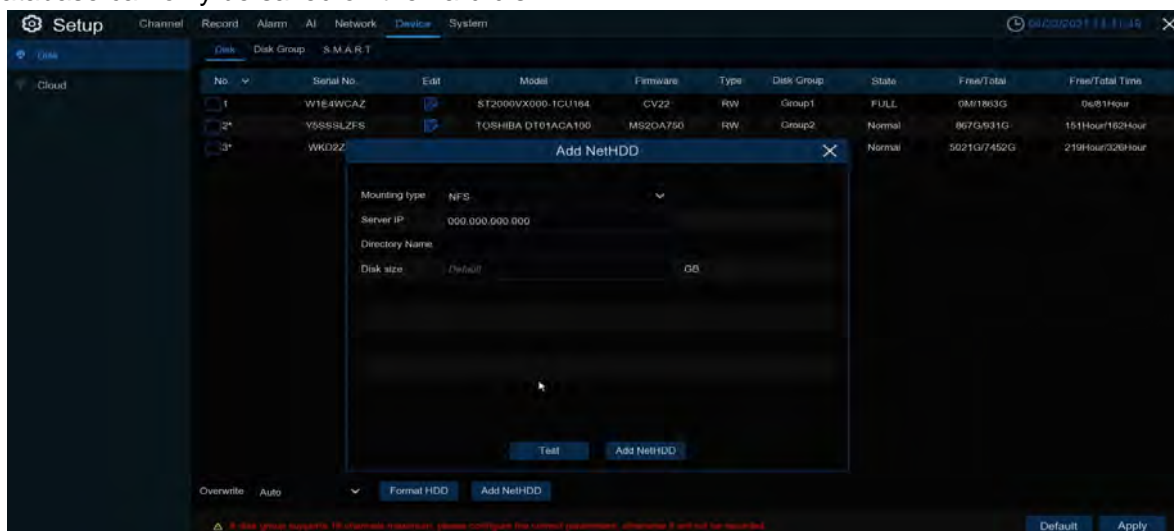

Mounting Type Mounting mode (NFS or CIFS) NFS does not need to enter the NAS account password, whereas CIFS requires the NAS account and password.

**User Name:** Enter the NAS account (unselectable in NFS mode).

**Password:** Enter the Password of the NAS (unselectable in NFS mode).

**Server IP:** Enter the NAS IP address.

**Directory Name:** Enter the folder where you want to store data in the NAS.

**Disk Size:** Sets the Size of the network hard drive.

**Test:** tests whether the NAS is connected.

**Add NetHDD:** Click to Add NAS.

**Overwrite:** Use this option to overwrite the old recordings on the HDD when the HDD is full. For example, if you choose the option 7 days then only the last 7 days recordings are kept on the HDD. To prevent overwriting any old recordings, select **OFF**. If you have disabled this function, please check the HDD status regularly, to make sure the HDD is not full. Recording will be stopped if HDD is full.

**Record on ESATA:** This menu only displayed when your DVR is coming with an e-SATA port on the rear panel. It will allow to record the video to external e-SATA HDD to enhance your HDD capacity. If the e-SATA recording function is enabled, e-SATA backup function will be disable

If your DVR supports to install multiple HDDs, the edit icon  appears in your system, you can click it to edit the HDD as below:



**Disk Type:** Read-write, read-only, and redundant.

Read-write mode is the normal status for a HDD to save recording or search recording to play.

To prevent important video data from being overwritten during cyclic recording, the HDD can be set as **Read-only** mode. New recording will be not able to save into this read-only HDD. You can still search recording from this read-only HDD to play.

A **Redundant** HDD can be used to automatically backup video footage on the recording (read-write) hard drive. When a redundant HDD is set, the system can be set to record cameras in parallel to both the recording hard drive and the redundant hard drive in case of hard drive failure.

### 5.6.1.1 Disk Group

If your DVR supports to install multiple HDDs, you can configure the HDD to be different groups. HDD groups allow you to balance recordings across multiple hard drives. For example, you can record channels 1~4 to one hard drive and 5~8 to a second hard drive. This can reduce the amount of wear on the hard drives and may extend the life of the hard drives.

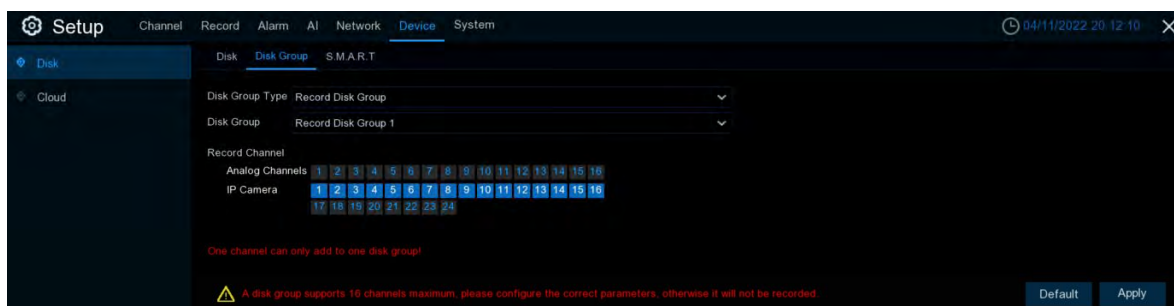

1. Use the dropdown next to **Disk Group Type** to select the type of group to configure.
2. Use the dropdown next to **Disk Group** to select the specific group within the selected group type.
3. Click the numbered boxes representing channels to record channels to HDDs in the selected group.
4. Click **Apply** to save.



5.6.1.2 S.M.A.R.T

This function can be used to display technical information on the hard drive installed inside your DVR. You can also perform a test (there are three types available) to evaluate and detect potential drive errors.

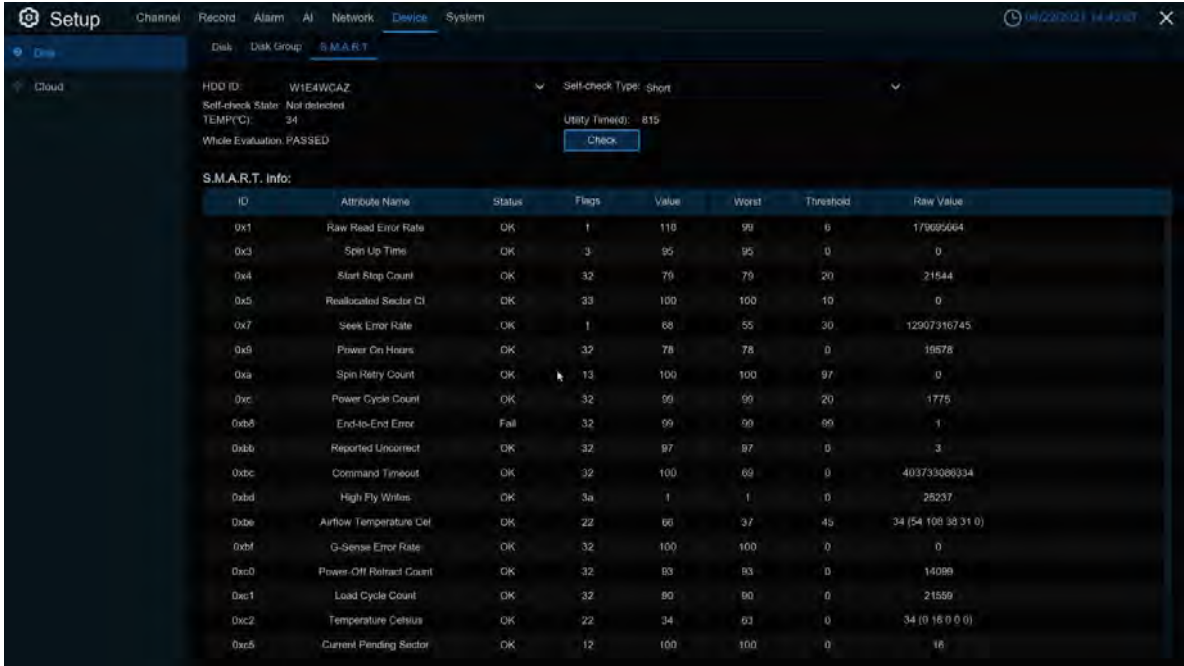

**Self-check Type:** There are three types available:

**Short:** This test verifies major components of the hard drive such as read/write heads, electronics and internal memory.

**Long:** This is a longer test that verifies the above as well as performing a surface scan to reveal problematic areas (if any) and forces bad sector relocation

**Conveyance:** This is a very quick test that verifies the mechanical parts of the hard drive are working.

**Note:** When performing the test, your DVR will continue to work normally. If you find a hard disk S.M.A.R.T error, you can continue to use the hard disk, but there is a risk of losing recorded data. It is recommended to replace the hard disk with a new one.

5.6.2 Cloud

Your DVR has the ability to upload snapshots to the cloud service via Dropbox which is a free service that allows you to easily store and share snapshots and always have them on hand when you need them.

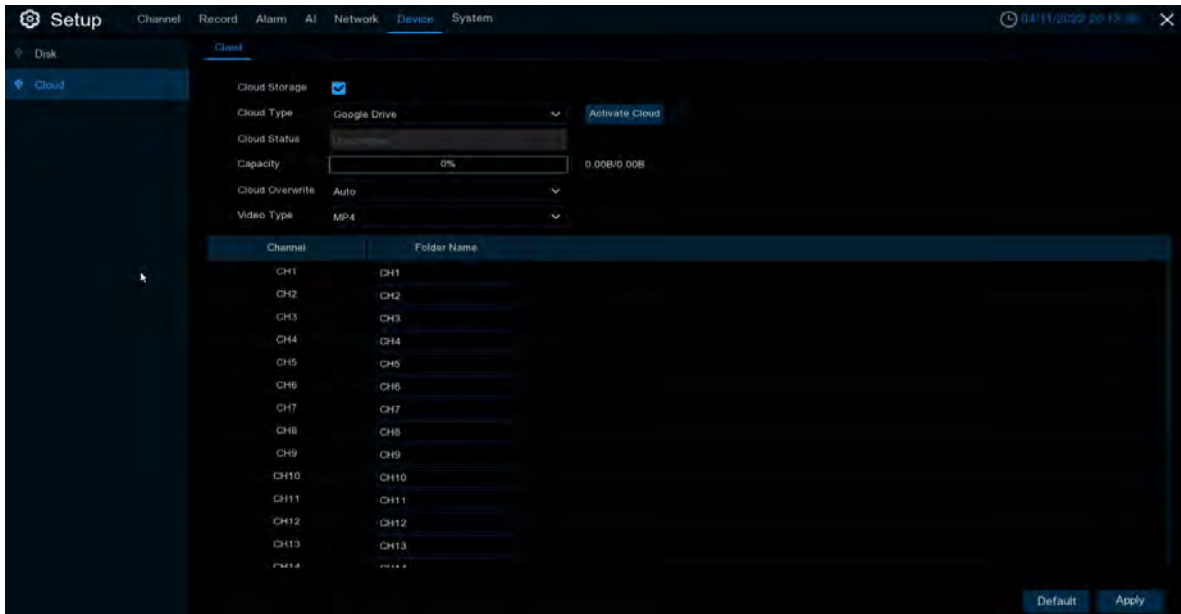

Before activating the cloud function, we recommend that you create a Dropbox account using the same email address and password used for your DVR. Go to [www.dropbox.com](http://www.dropbox.com), nput your name, email address and password, agree to the terms & conditions then click the sign up button.

**Cloud Storage:** Check to enable the function.

**Cloud Type:** To select cloud type, Dropbox and Google Drive are optional.

**Cloud Status:** To show cloud activation status

**Capacity:** To show the remaining space of cloud storage.

**Cloud Overwrite:** Sets the Cloud storage Overwrite frequency.

**Video Type:** Sets the Video format to be uploaded to the cloud.

**Folder Name:** storage the Name of the Folder that stores videos and images on the channel

**Activate Cloud:** Click to activate the function. After a short moment, you will see a message on-screen. An activation link has been sent to your email (the email address which you had set to receive email alerts in [5.5.3.1 Email Setting](#) Check your email then click the link to activate. You will be taken to the Dropbox website. Click “Allow” to finalize the activation. Repeat these steps if you would like to enable cloud storage for the other cameras available.

## 5.7 System

Change general system information such as date, time and region, edit passwords and permissions, and more.

### 5.7.1 General

#### 5.7.1.1 General Configuration

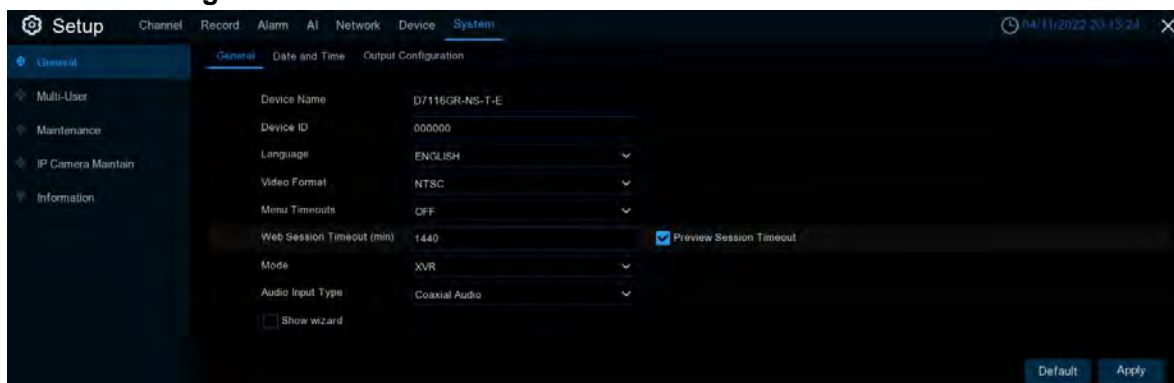

**Device Name:** Enter the DVR name. The name can contain letters and numbers.

**Device ID:** Enter the DVR device ID. The device ID is used to identify the DVR and can only be made up of numbers. For example, two DVRs are installed in the same location, one of which has a device ID of 000000, and the other has a device ID of 111111. When you want to operate a DVR with the remote control, both DVRs may receive signals from the controller and act at the same time. If you only want to control the DVR with ID 111111, you can use the remote control to enter the device ID 111111 in the login page for further operation.

**Language:** Select the language in which you want to display the system menu. Multiple languages are available.

**Video Format:** Choose a video format that suits your region.

**Menu Timeouts:** Click the drop-down menu and select the time to exit the main menu when the DVR is idle. You can also disable this function by selecting off (password protection will be temporarily disabled)

**Web Session Timeout (min) :** Set the time to automatically log out of the web after a period of no operation when using the wed side to log in.

**Preview/Playback Session Timeout:** After enable, in the preview or playback, to avoid automatic logout

of the web side.

**Mode:** XVR or DVR, XVR mode will allow you to add IP cameras to the DVR. If the mode is changed from xvr to DVR, all added IP cameras will be removed.

**Audio Input Type:** Select the analog channel Input Audio source. **Base-band Audio** is used to Input the Audio source on the board. Select **Coaxial Audio** using the analog Audio input as the Audio source.

**Show Wizard:** Check this option if you want to display the startup wizard every time you open or restart a DVR

### 5.7.1.2 Date and Time

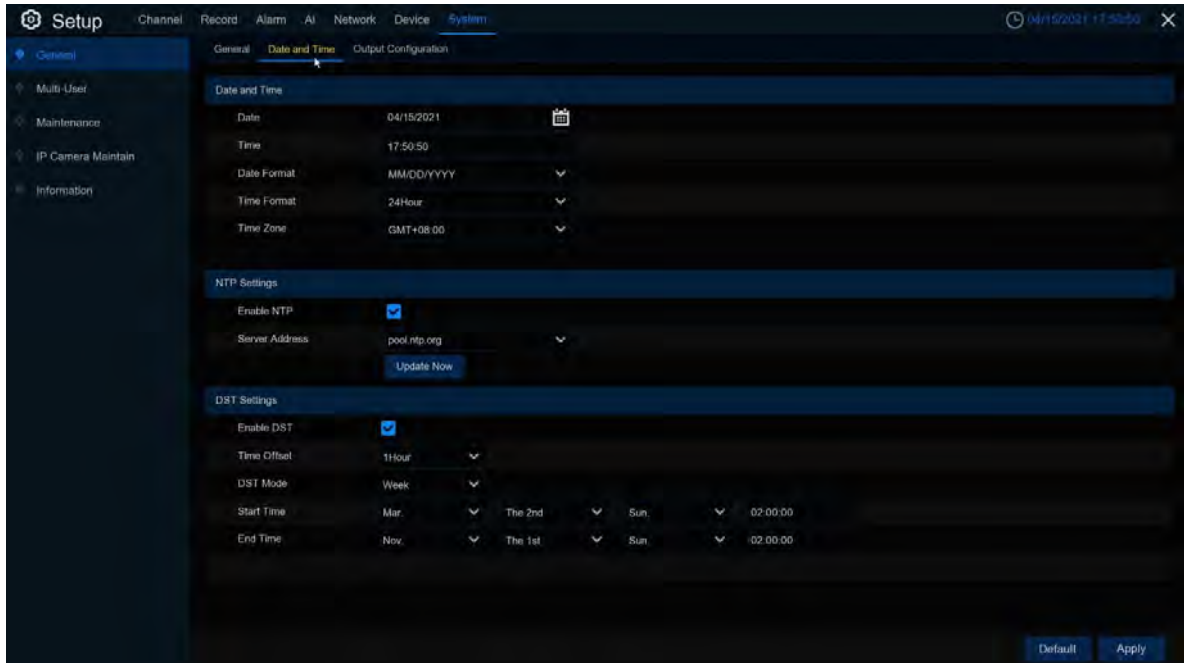

#### Date & Time

**Date:** Click the calendar  to change the date.

**Time:** Click the time box to change the time.

**Date Format:** Select the preferred date format.

**Time Format:** Select the preferred time format.

**Time Zone:** Select the time zone associated with your region or city.

#### NTP

The NTP (Network Time Protocol) function allows your DVR to automatically sync its clock with a time server. This gives it the ability to constantly have an accurate time setting (your DVR will periodically sync automatically).

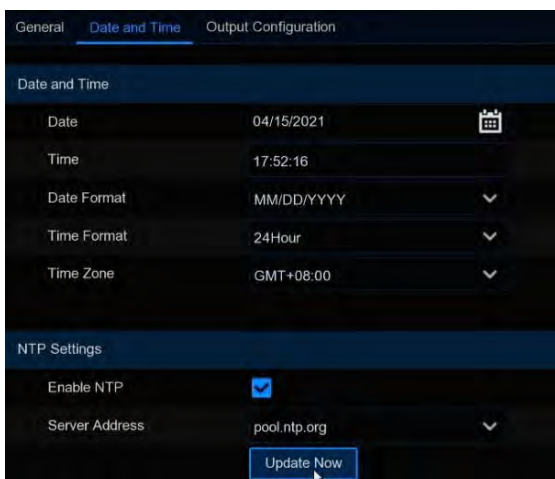

Check to enable the **NTP**, and select a **Server Address**, click Update Now to manually sync the date & time.

Click **Apply** to save your settings.

When NTP function is enabled, system will update the system time at 00:07:50 per day, or

## DST

The DST (Daylight Saving Time) function allows you to select the amount of time that Daylight Saving has increased by in your particular time zone or region.

The screenshot shows the 'Date and Time' configuration page. It is divided into three main sections: 'Date and Time', 'NTP Settings', and 'DST Settings'.  
**Date and Time:** Date: 04/15/2021 (with a calendar icon), Time: 17:53:04, Date Format: MM/DD/YYYY, Time Format: 24Hour, Time Zone: GMT+08:00.  
**NTP Settings:** Enable NTP: , Server Address: pool.ntp.org, with an 'Update Now' button.  
**DST Settings:** Enable DST: , Time Offset: 1Hour, DST Mode: Week, Start Time: Mar., The 2nd, Sun., 02:00:00, End Time: Nov., The 1st, Sun., 02:00:00.

**Enable DST:** If Daylight Saving applies to your time zone or region, check this option to enable.

**Time Offset:** Select the amount of time that Daylight Saving has increased by in your time zone. This refers to the difference in minutes, between Coordinated Universal Time (UTC) and the local time.

**Enable DST:** You can select how Daylight Saving starts and ends:

**Week:** Select the month, a particular day and time when Daylight Saving starts and ends. For example, 2 a.m. on the first Sunday of a particular month.

**Date:** Select the start date (click the calendar icon ) , end date and time when Daylight Saving starts and ends.

**Start Time / End Time:** Set the start time and end time for Daylight Saving.

### 5.7.1.3 Output Configuration

This menu allows you to configure video output parameters.

**Video Output:** To choose the output options:

**LIVE-OUT** is used to configure the main output parameters.

**SPOT-OUT** is an optional option to config the VGA spot output parameters.

The screenshot shows the 'Setup' page with the 'Output Configuration' tab selected. The 'Video Output' is set to 'LIVE-OUT'. Other settings include: Seq Mode:  LAYOUT 1, SEQ Dwell Time: 5, VGA/HDMI Resolution: 4K(3840x2160), Scale And Offset: Setup, Cursor Hidden Delay: 5s, and Cursor Acceleration: a slider set to 0. There are 'Default' and 'Apply' buttons at the bottom right.

Choose **LIVE-OUT** from the Video Output drop-down menu.

**SEQ Mode:** Select how many video channels you would like to display when your DVR is in sequence mode.

**SEQ Dwell Time:** Enter in seconds the maximum length of time you would like to display a video channel in sequence mode before displaying the next video channel (300 seconds is the maximum).



**Output Resolution:** Select a display resolution that is suitable for your TV. 1920 x 1080 will suit most TVs. If your DVR supports 4K output resolution, you can select either 2K (2560 x 1440) or 4K (3840 x 2160) to take advantage of the higher resolution that your 4K TV provides.

**Scale and Offset:** The DVR supports to adjust the size & position of the display screen to match your monitor or TV. Click **Setup** button to adjust.

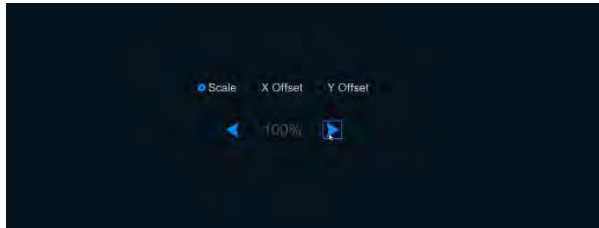

**Scale:** To adjust the size of the displayed screen by scale.

**X Offset:** To move the displayed screen to left or right.

**Y Offset:** To move the displayed screen to up or down.

Click once or long press the left button of your mouse on the arrow to adjust the size and position, or you can scroll the wheel of the mouse to adjust. Click the right button of your mouse to exit, and click **Apply** to save your modifications.

**Cursor Hidden Delay:** Click the drop-down menu to select the time your DVR will hide the mouse cursor when idle. You can also disable this by selecting “OFF” (password protection will be temporarily disabled).

**Cursor Acceleration:** To adjust the speed to move the mouse cursor.

**Transparency:** Click and hold the slider left or right to change how transparent the Menu Bar and Main Menu will appear on-screen. Adjust accordingly.

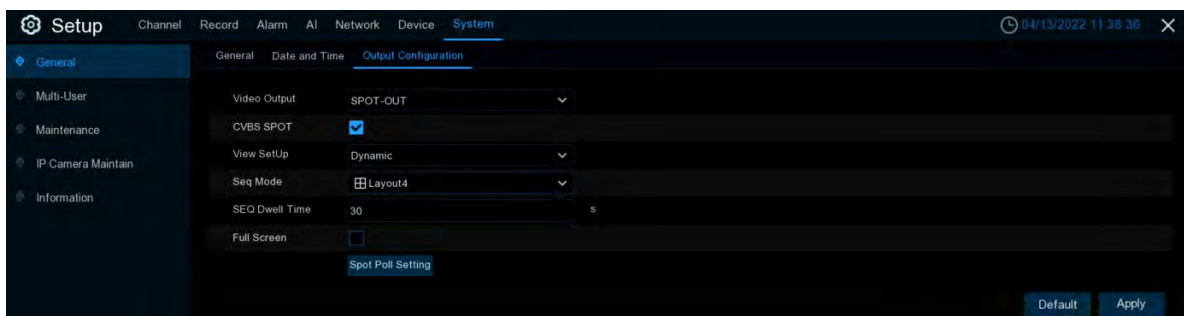

**Select the SPOT-OUT mode in the Video Output drop-down menu.**

**CVBS SPOT:** Check and enable the CVBS interface to output the video.

**View SetUp:** Select the preview mode of the CVBS interface output video, with two Dynamic and Static modes.

**SEQ Mode:** Number of video channels to display when selected in Dynamic mode.

**SEQ Dwell Time:** Set the wheel patrol time in seconds.

**Full Screen:** The alarm channel is displayed on the full screen when the alarm is checked.

**Spot Poll Setting:** Select the channel for the tour in Dynamic mode.



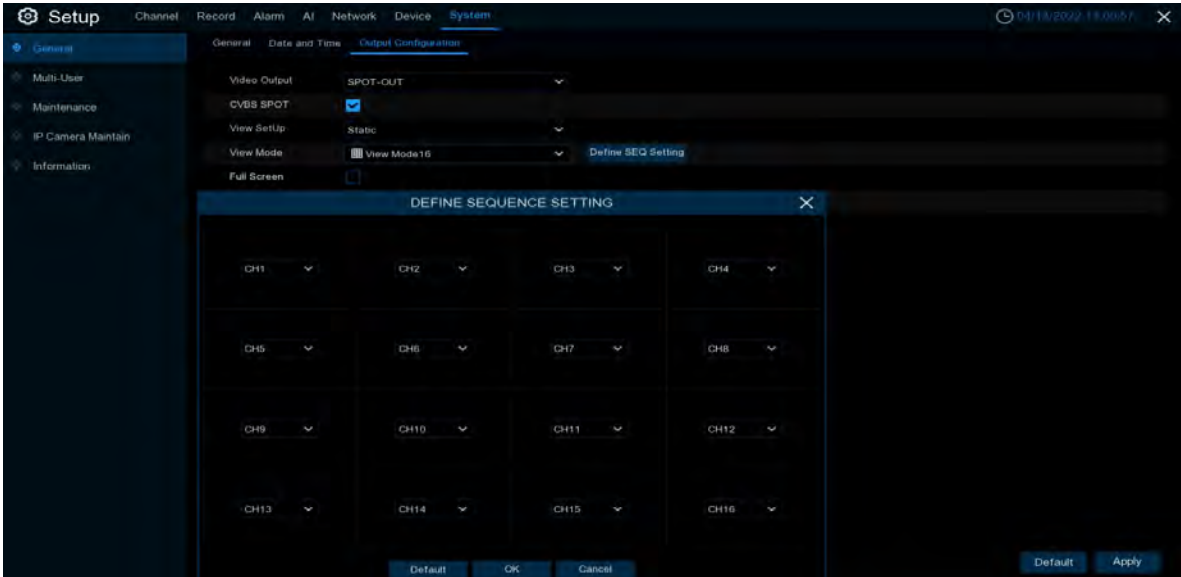

**View Mode:** Select the number of split screens to display in Static mode.

**Define SEQ Setting:** Select the channel screen for each split screen in Static mode.

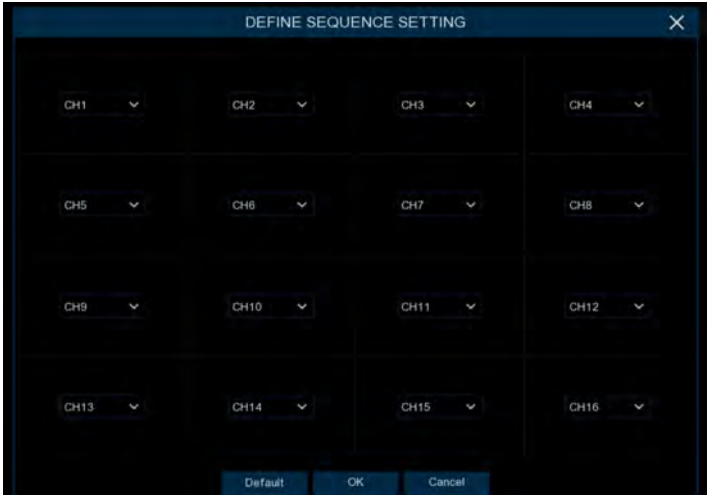

5.7.2 Multi-user

This menu allows you to configure the user name, password and user permission.

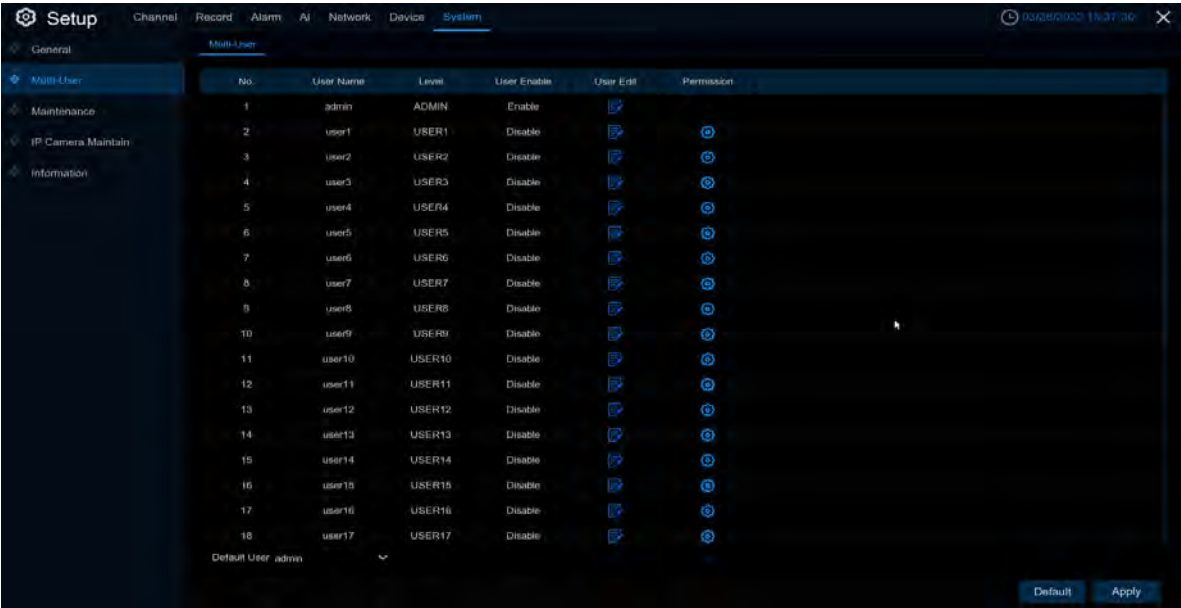

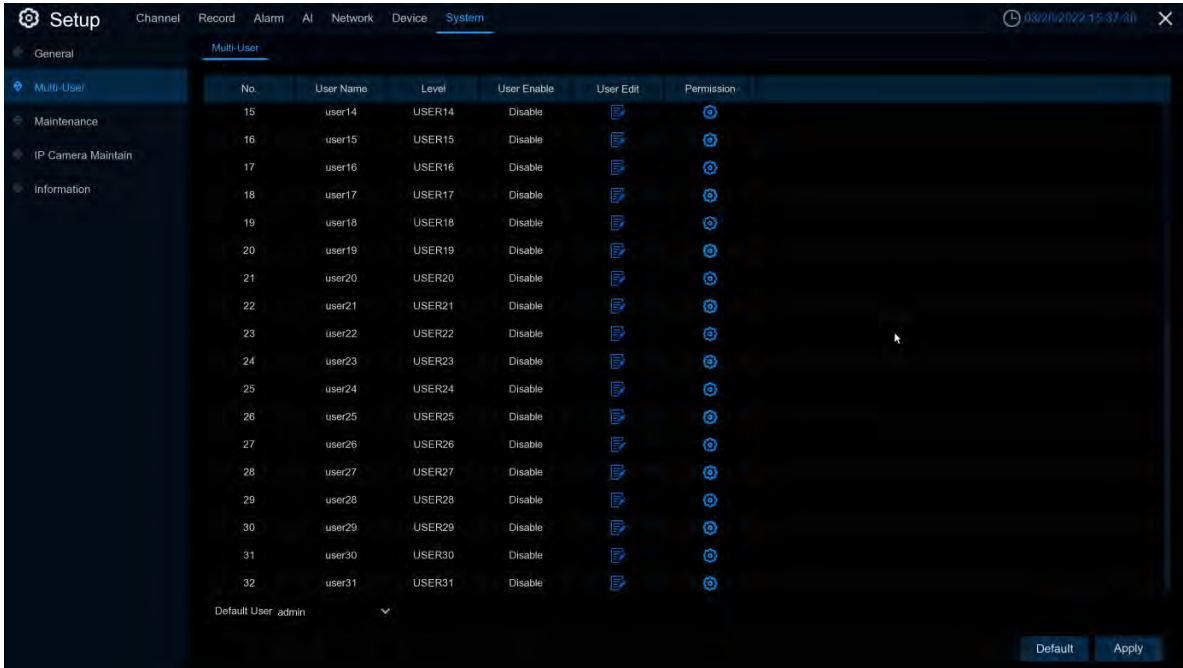

The system supports the following account types:

- **ADMIN — System Administrator:** The administrator has full control of the system, and can change both administrator and user passwords and enable/disable password protection.
- **USER — Normal User:** Users only have access to live viewing, search, playback, and other functions. You may set up multiple user accounts with varying levels of access to the system.

**Default User:** Default user, that is, the default user to log in after the DVR restarts.

### 5.7.2.1 Changing Password and Add New Users

To change the password for the administrator or user accounts, click the User Edit icon . The password has to be a minimum of 8 characters and can contain a mixture of numbers and letters. Enter your new password again to confirm, and then click **Save** to save your new password. You will be required to input your old password to authenticate.

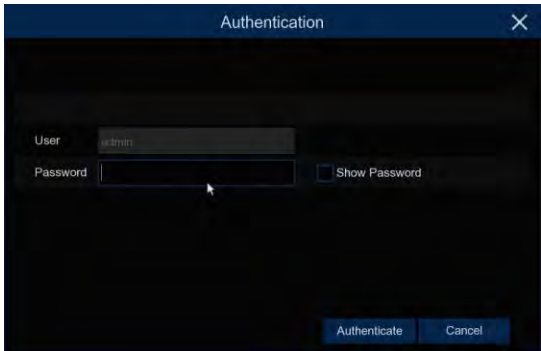
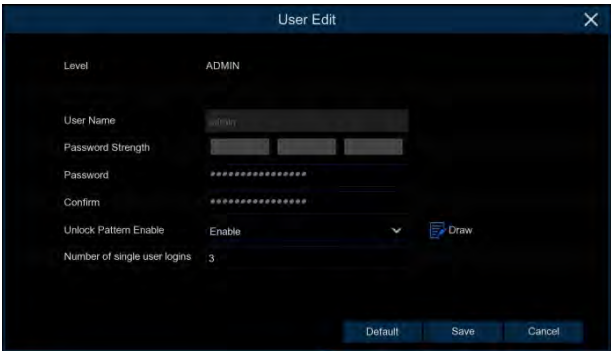

### 5.7.2.2 Add New Users

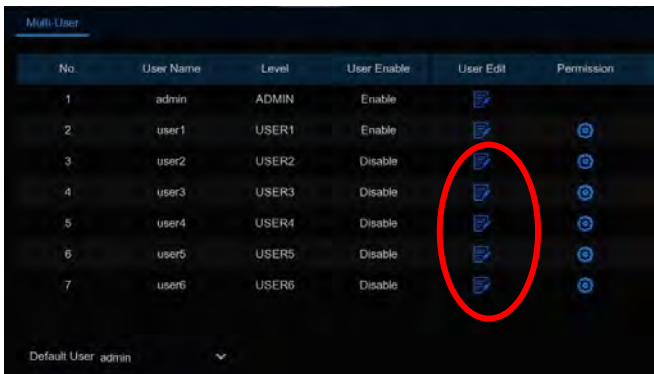

1. Select one of the user accounts that is currently disabled, click the User Edit icon 

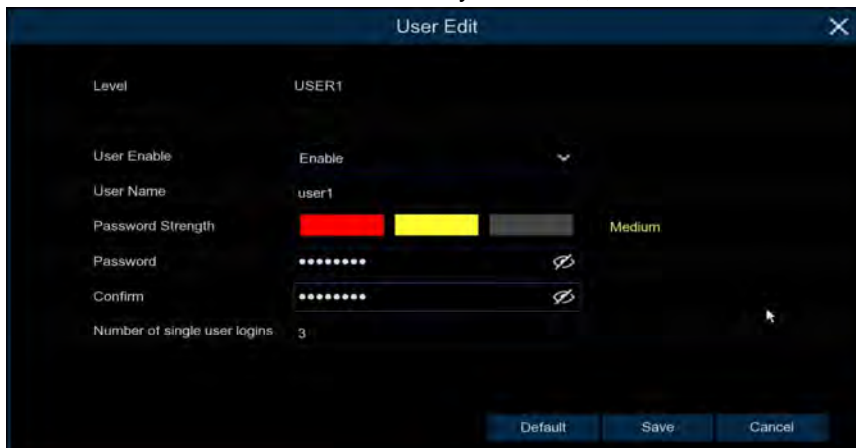

2. Select **Enable** from the drop-down next to **User Enable**.
3. Click the field next to **User Name** to change the user name for the account.
4. Select **Enable** from the drop-down next to **Password Enable**.
5. Click the field next to **Password** to enter the desired password.
6. Click the field next to **Confirm** to reenter the password.
7. Click the area next to Number of **Single User** Logins to set the Number of single user logins.
8. Click **Save**. You will be required to input your Admin password to authenticate.

### 5.7.2.3 Setting User Permissions

The administrator account is the only account that has full control of all system functions. You can enable or disable access to certain menus and functions of each user account.

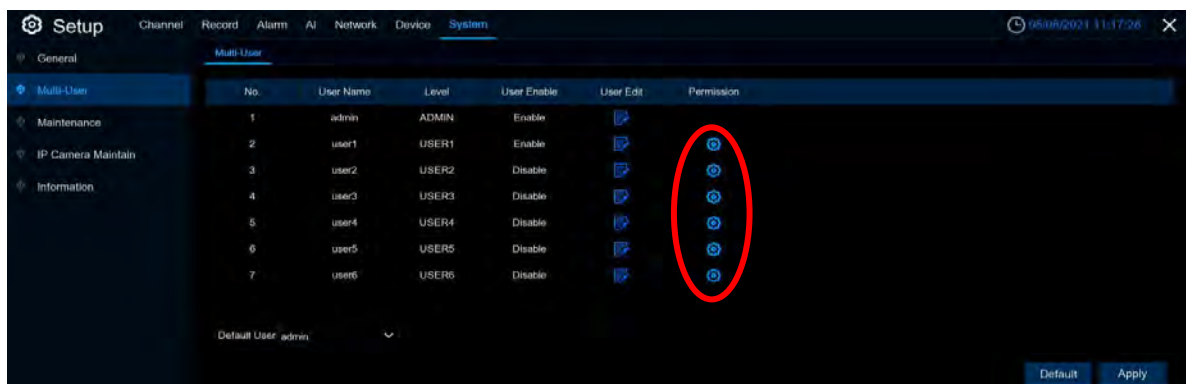

1. Click the edit icon  under Permission tab

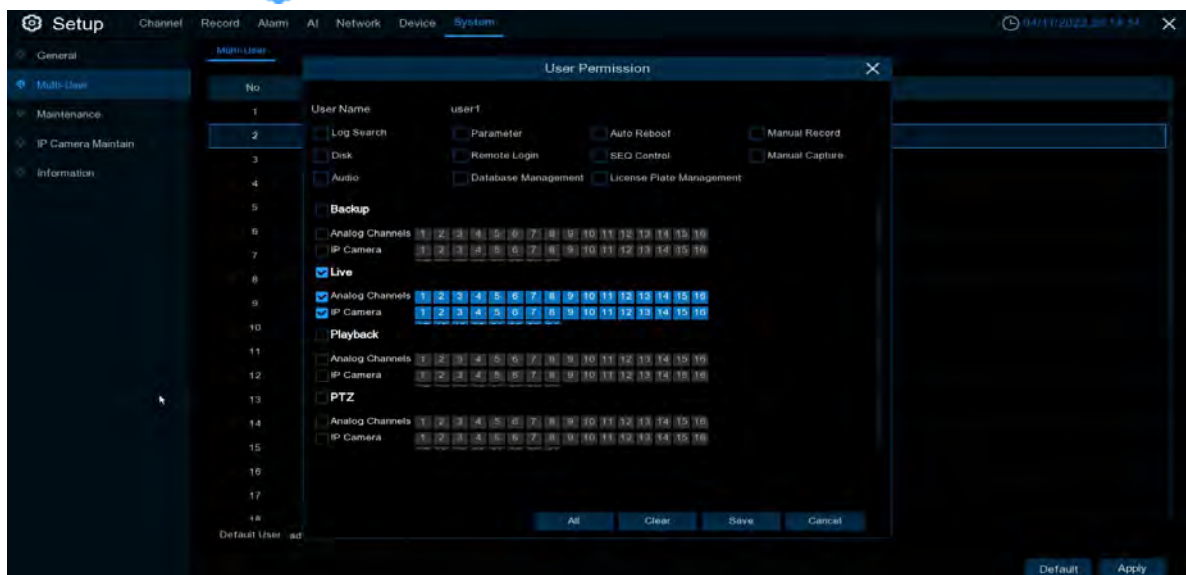



2. Set the user's permission and check the box corresponding to the function. Click **All** to select all of the boxes. Click **Clear** to clear all of the boxes.  
 User password permission setting, the administrator can select the general user permission as required. Have the following privileges to select:
  - **Log search:** You can view all the logs of the system;
  - **Parameter setting:** you can set the parameters for all the pages;
  - **Maintenance:** upgrade the version of the operating system, restore the factory value, equipment restart, equipment shutdown and other items to maintain the system
  - **Manual recording:** can manually start video recording and can manually stop video recording
  - **Hard disk management:** it can manage and control the operation of the hard disk and the U disk;
  - **Remote Logon:** Do you have remote access to the DVR
  - **Polling control:** View a live preview of all channels
  - **Manual grasp:** can manually start grasp and can manually stop recording
  - **Audio:** Control the channel audio control and intercom
  - **Database management:** Can you operate on the AI database
  - **License plate management:** whether you can operate the license plate library
  - **Backup:** After the enabling box before Backup and select the channel to be backed up, the average user has permission to back up the selected channel video.
    - **Preview:** After the enabling box before Preview and select a channel to view the preview, the average user has permission to monitor the live preview of the selected channel.
    - **Video playback:** After the enabling box "" before the video playback, and select the visible channel, the average user has the permission to play back the selected channel video.
    - **PTZ:** After the enabling box "" before "PTZ" and select an operational channel, the average user has permission to operate the PTZ.
3. Click Save to save your modifications.

### 5.7.3 Maintenance

In this section, you will be able to search & view the system log, load default settings, upgrade the system, export & import system parameters and manager system auto reboot.

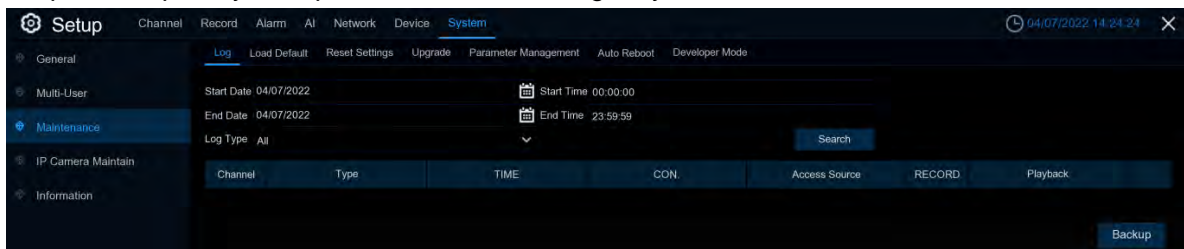

#### 5.7.3.1 Log

The system *log* shows you important system events, such as motion alarms and system warnings. You can easily create a backup file of the system *log* for a set time period to a USB flash drive.

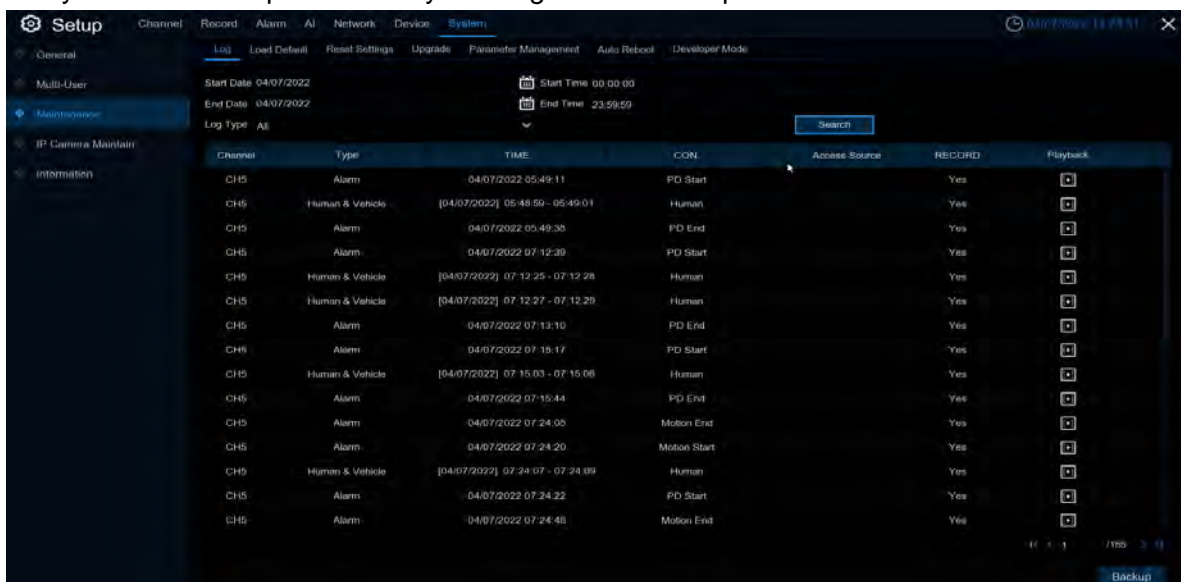

### Log Searching and Backing Up:

1. Click the field next to **Start Date & Start Time** to choose the starting date & time for your search from the on-screen calendar.
2. Click the field next to **End Date & End Time** to choose the end date & time for your search from the on-screen calendar.
3. Select the type of events you would like to search for from the dropdown next to **Log Type**, or select **All** to see the entire system log for the selected time period.
  - **system:** System setting, restart, automatic restart, upgrade, time setting, and NTP timing.
  - **configuration:** IPC preview control, Privacy Area settings, recording mode settings, recording schedule Settings, master code flow settings, network settings, subcode flow settings, mail settings, color settings, mobile detection settings, hard disk settings, multi-user settings, NTP settings, image control, mobile code stream settings, RTSP settings, IP filtering settings, system recovery factory settings, audio settings, video occlusion alarm settings, export settings, and import settings.
  - **alarm:** Mobile detection start, mobile detection end, IO alarm start, IO alarm end, PID, PID, LCD start, LCD, SOD, SOD, PD & VD, PD & VD, FD, FD, CC, CC, CD, CD, QD, QD, sound alarm and sound alarm end.
  - **account:** Login, out and switch users.
  - **recording:** Search, playback, and backup.
  - **storage:** Format hard, full, and hard disk errors.
  - **network:** Network drops, networking, networking, network errors, and network pattern changes.
4. Click **Search**.
5. Browse system log events from your search period:
  - o Video events can be played back instantly by clicking in the **Playback** column. Right-click to return to your search results.
  - o Use the **⏪ < / > ⏩** buttons in the bottom-right corner of the menu to move between pages of system log events.
6. Click **Backup** to create a backup of the system log for your search period. Please make sure your flash drive has been connected to the DVR's USB port.
7. The backup drive menu appears. Navigate to the folder you want the backup file to be saved in, then click **OK** to begin.

### 5.7.3.2 Load Default

Reset the DVR settings to its out-of-box state. You can choose to reset all settings at once, or just settings on specific menus. Restoring default settings will not delete recordings and snapshots saved to the hard drive.

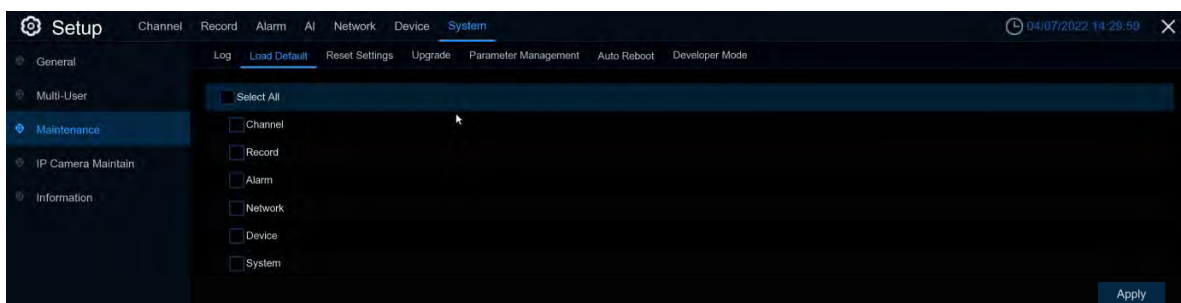

Check the items you want restore, or check **Select All** to choose all items. Click **Apply** to load default settings of your chosen items.

### 5.7.3.3 Reset setting

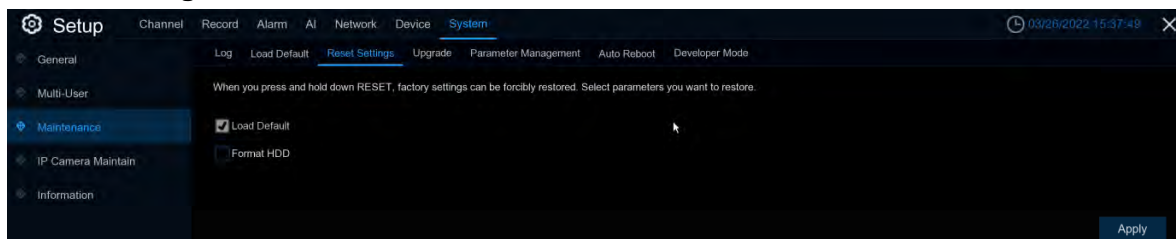

You can set whether to format the hard disk when restoring the default

### 5.7.3.4 Upgrade

#### 5.7.3.4.1 USB Upgrade

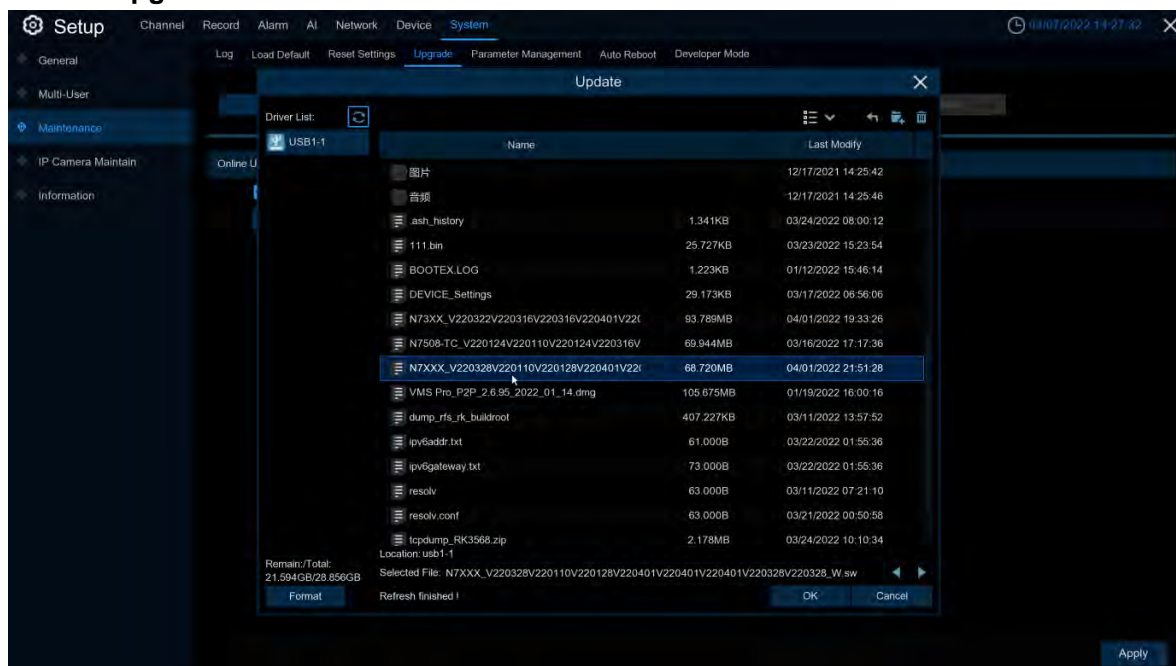

1. Copy the firmware file (.sw file) to your USB drive, and insert the USB flash drive into the DVR's USB port.
2. Click **Select File** button to choose the firmware file in your USB flash drive, then Click **OK**.
3. Click **Upgrade** button to start system upgrade. The system upgrade will last around 5-10 minutes, please do **NOT** power off the DVR or remove the USB from DVR during firmware upgrade.

#### 5.7.3.4.2 Online upgrade

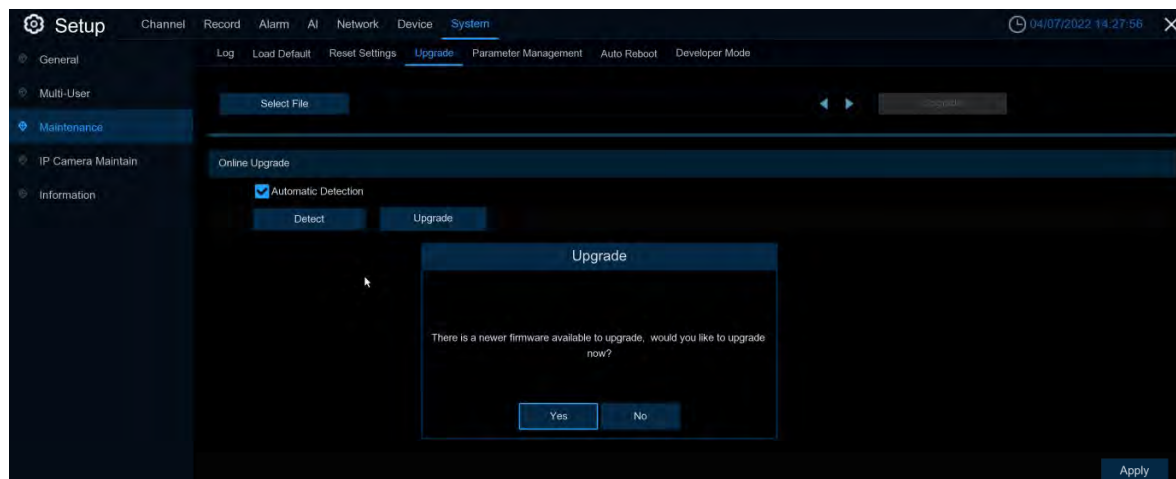

By burning the upgrade file website and the online upgrade switch parameters, you can upgrade the board end online through the network server (HTTP or FTP).

(1) When the **automatic detection** is opened, the initial power on the board will first judge whether it is automatic maintenance and restart, and if it is automatic maintenance, skip to detect whether there is a new upgrade package (judgment method: the current system time is considered automatic maintenance within 30 minutes later than the automatic maintenance time). If it is not automatic maintenance and restart, it will delay 5 minutes to check whether there is a new upgrade package. If there is, the upgrade status bar shows "online upgrade". When the user chooses this channel and click upgrade, they will download the upgrade package.

(2) When the **automatic detection** is started, there will be a new upgrade package during the operation. If there is, the upgrade status bar of the upgrade page shows "online upgrade". When the user clicks the **upgrade**, he will download the upgrade package. The detection period is a random number of 18 to 23 hours after the restart time point (including automatic maintenance). After it is obtained by random acquisition during the operation, the period will not change until the system stops running (since the upgrade cycle is 18 to 23 hours, in order to prevent excessive bandwidth from downloading the upgrade package, the first detection cycle of the upgrade will subtract 5 hours from the random value of 18 to 23 hours, 5 hours in advance, and the subsequent period)

(3) During the operation of the system, users can click on the upgrade page to check whether there is a new upgrade package. After clicking, there will be a pop-up box to prompt you to detect. After the detection, the upgrade status bar will display the results. When a new upgrade package is detected and the user clicks on the upgrade, they download the upgrade package. Note: Manual detection does not affect periodic detection

(4) When **automatic detection** is changed from open to closed, periodic detection is stopped; from closed to open, periodic detection is opened for a random number of 18 to 23 hours after this time point. And delay by 1 minute to check if there is a new upgrade package (1 minute delay is to prevent users from switching back and forth on and off)

Note: If the user turns off again during the delay process, the timing will exit, and you will no longer check for a new upgrade package. After opening again, regain)

**Note:** The Neutral program currently does not support FTP online upgrades

### 5.7.3.5 Parameter Management

You can *export* the main menu settings you have configured to a USB flash drive, or import an exported setting file from USB flash drive to the DVR.

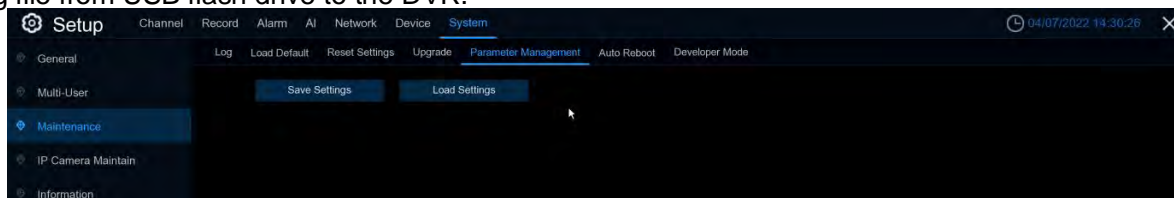

**Save Settings:** Click to save the DVR current system settings to the USB device. You will be required to input the Admin password to authenticate.

**Load Settings:** Once you have created a system settings export, you can import the settings on another DVR. Click **Load Settings** button to navigate to the system settings file you want to import from your USB flash driver. You will be required to input the Admin password to authenticate.

### 5.7.3.6 Auto Reboot

This menu allows the system to auto reboot the DVR regularly. It is recommended to leave this function enabled, as it maintains the operational integrity of your DVR.

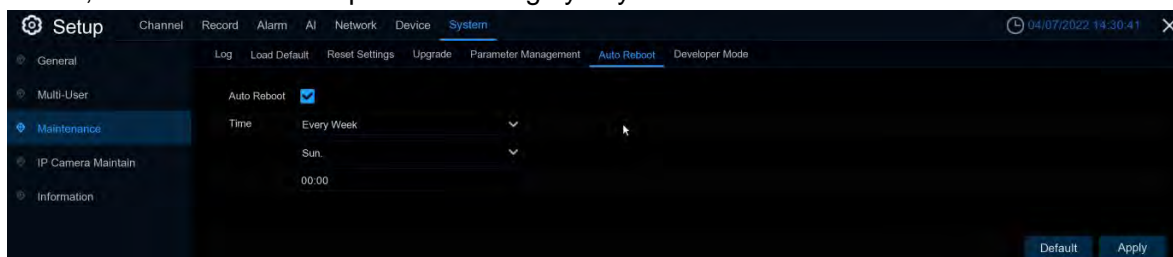

**Auto Reboot:** Check to enable.

**Time:** You can set the DVR to reboot by day, week or month.



### 5.7.3.7 Developer Mode

Only some devices support. This menu can save the serial port log to the USB flash disk.

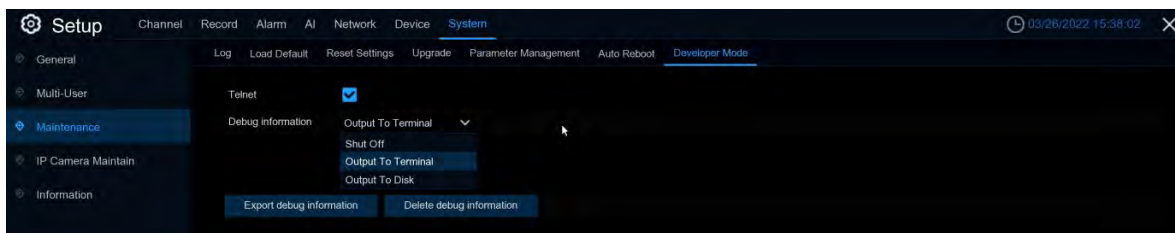

**Telnet:** Enable it, can use Telnet to login device

**Debug information:** You can select the location for saving serial port logs

**Shut Off:** Do not save serial port logs

**Output To Terminal:** Outputs serial port logs To the serial port

**Output To Disk:** Saves serial port logs To disks

**Export debug information:** Exports serial port logs to a USB flash drive.

**Delete debug information:** Deletes collected serial port logs.

### 5.7.4 IP Camera Maintain

This menu allows you to upgrade the IP camera's firmware and restore default settings of IP camera.

#### 5.7.4.1 Upgrade IP Camera

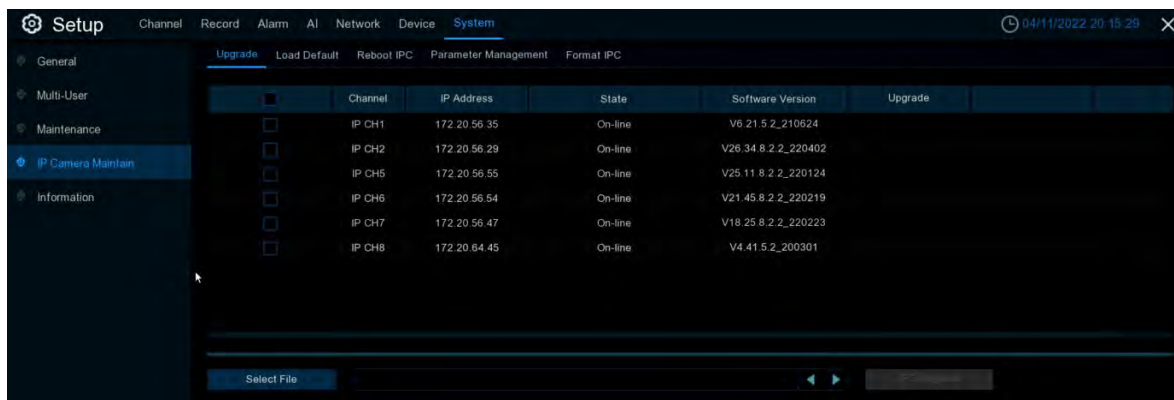

1. Choose one of the IP cameras you want to upgrade firmware
2. Click **Select File** select the update file from your USB flash drive, then click **OK**.
3. Click IPC Upgrade button to start upgrading. You will be required to input the Admin password to authenticate. Please do **NOT** power off the DVR and IP camera or remove the USB during the upgrading.

**Auto Upgrade:** Some IPC supports upgrading using the upgrade package in FTP. You only need to open FTP in the IE menu of IPC. Then upload the upgrade package to upgrade IPC FTP on DVR. Select **enable / disable** to enable or disable the feature.

**Automatic Detection:** Automatically detect upgrades. Check whether there is the latest upgrade package in the FTP server ([5.7.3.4.2 update online](#)) If yes, you will be prompted whether to upgrade.

**Detect:** Manually check for the latest upgrade package.

**Upgrade:** If the latest upgrade package is detected, click to upgrade.

### 5.7.4.2 Load Default Settings for IP Camera

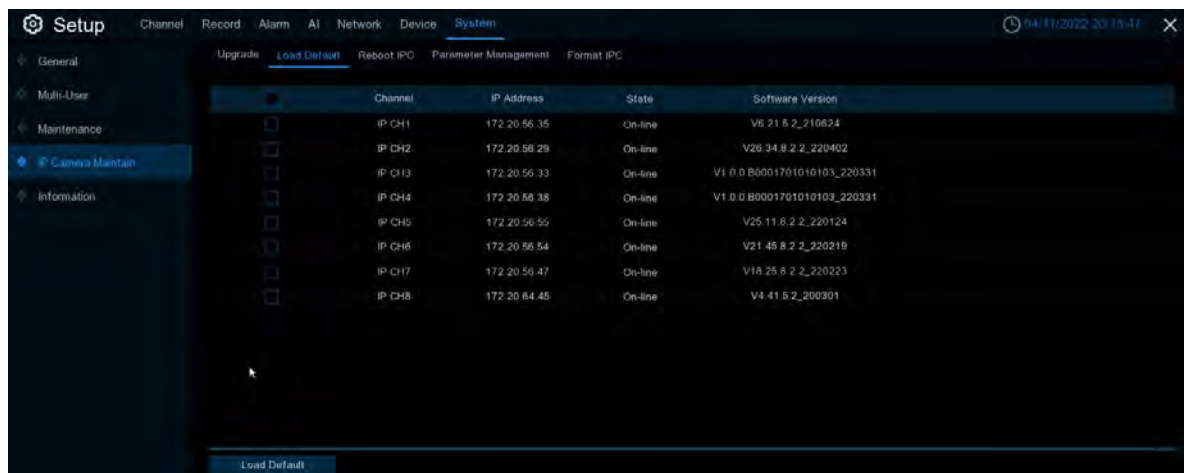

1. Choose the IP cameras you want to restore.
2. Click **Load Default** to restore settings. You will be required to input the Admin password to authenticate.

### 5.7.4.3 Reboot IPC

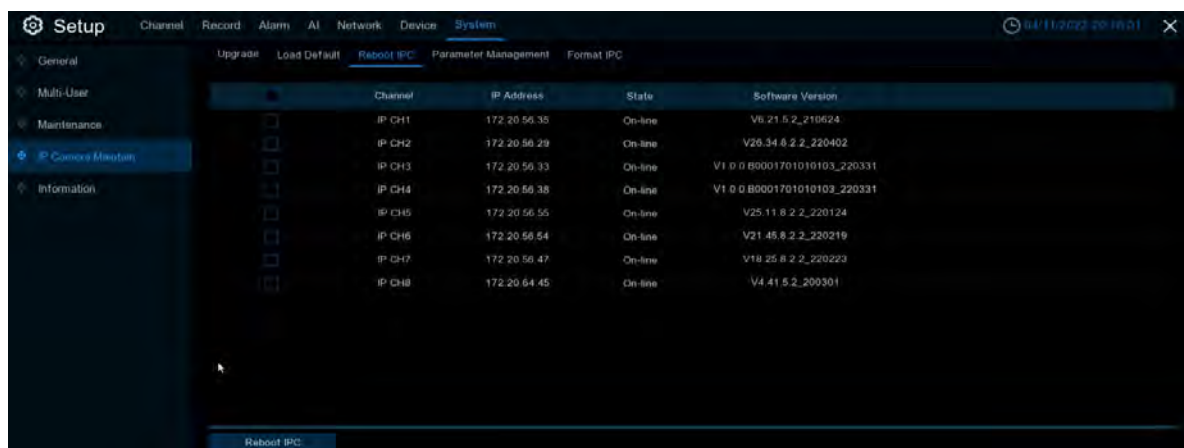

You can restart IPC in this menu. Check IPC and click **reboot IPC**.

### 5.7.4.4 Manage IPC parameters

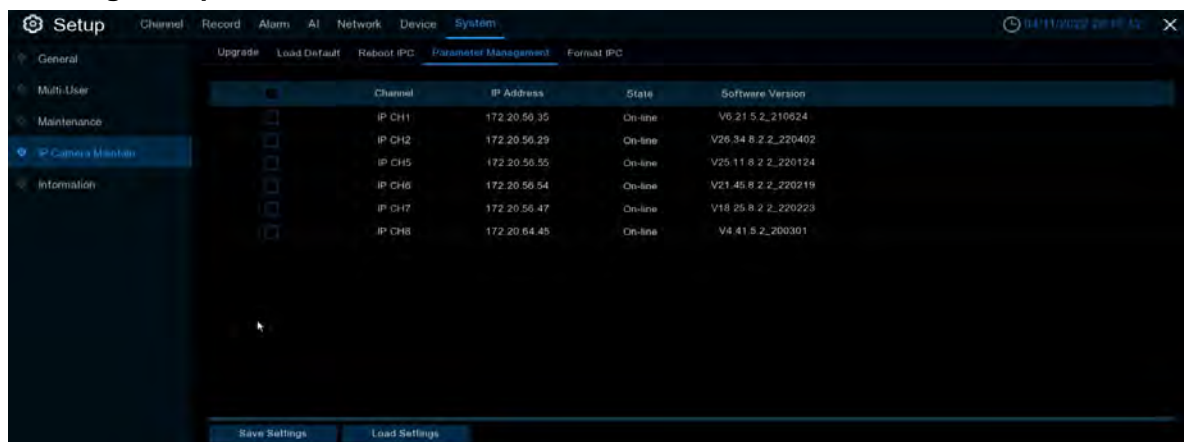

Export parameters, check IPC, click **Save settings**, and the USB flash disk path will pop up. After selecting the path, click OK to export IPC to USB flash disk; Check IPC and click **load settings** to import parameter files from USB flash disk into the IPC.

5.7.4.5 Format IPC

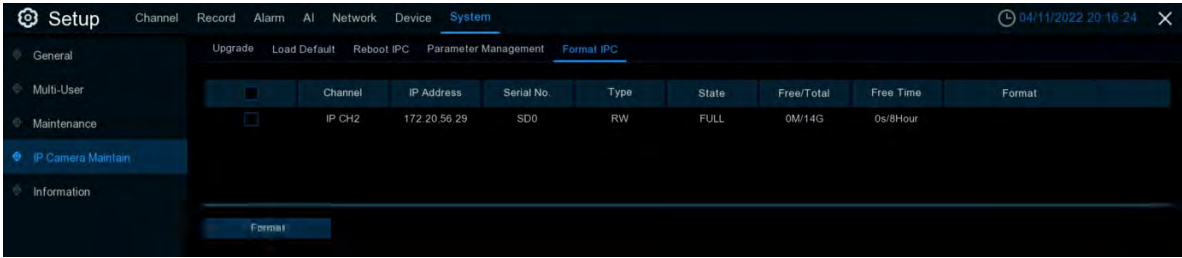

The SD card of the IPC connected with the API protocol can be detected. After selection, click **Format** to format the SD card of selecting the IPC.

5.7.5 System Information

This menu allows you to view the system information, channel information, record information & network status

5.7.5.1 Information

View system information such as device ID, device model name, IP address, MAC address, firmware version and more.



If your DVR supports P2P function, you will find the P2P ID & P2P QR code in the information page. You can scan this QR code with mobile app to remote view the DVR.

5.7.5.2 Channel Information

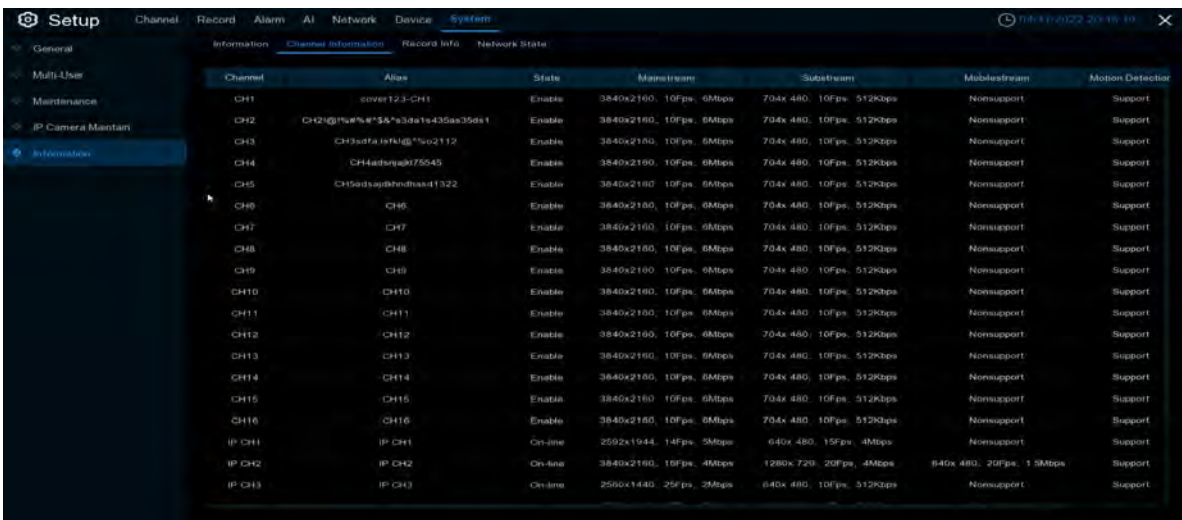

View channel information for each connected camera such as alias, mainstream and substream recording specifications, motion detection status & privacy zone.

5.7.5.3 Record Information

Channel	Record State	Record Switch	Stream Type	Resolution	FPS	Bitrate
CH1	ON	Enable	DualStream	3840x2160   704x480	10Fps   10Fps	6Mbps   512Kbps
CH2	ON	Enable	DualStream	3840x2160   704x480	10Fps   10Fps	6Mbps   512Kbps
CH3	ON	Enable	DualStream	3840x2160   704x480	10Fps   10Fps	6Mbps   512Kbps
CH4	ON	Enable	DualStream	3840x2160   704x480	10Fps   10Fps	6Mbps   512Kbps
CH5	ON	Enable	DualStream	3840x2160   704x480	10Fps   10Fps	6Mbps   512Kbps
CH6	ON	Enable	DualStream	3840x2160   704x480	10Fps   10Fps	6Mbps   512Kbps
CH7	ON	Enable	DualStream	3840x2160   704x480	10Fps   10Fps	6Mbps   512Kbps
CH8	ON	Enable	DualStream	3840x2160   704x480	10Fps   10Fps	6Mbps   512Kbps
CH9	ON	Enable	DualStream	3840x2160   704x480	10Fps   10Fps	6Mbps   512Kbps
CH10	ON	Enable	DualStream	3840x2160   704x480	10Fps   10Fps	6Mbps   512Kbps
CH11	ON	Enable	DualStream	3840x2160   704x480	10Fps   10Fps	6Mbps   512Kbps
CH12	ON	Enable	DualStream	3840x2160   704x480	10Fps   10Fps	6Mbps   512Kbps
CH13	ON	Enable	DualStream	3840x2160   704x480	10Fps   10Fps	6Mbps   512Kbps
CH14	ON	Enable	DualStream	3840x2160   704x480	10Fps   10Fps	6Mbps   512Kbps
CH15	ON	Enable	DualStream	3840x2160   704x480	10Fps   10Fps	6Mbps   512Kbps
CH16	ON	Enable	DualStream	3840x2160   704x480	10Fps   10Fps	6Mbps   512Kbps
IP CH1	ON	Enable	DualStream	2592x1944   640x480	14Fps   15Fps	5Mbps   4Mbps
IP CH2	ON	Enable	DualStream	3840x2160   1280x720	16Fps   20Fps	4Mbps   4Mbps
IP CH3	ON	Enable	DualStream	2560x1440   640x480	25Fps   10Fps	2Mbps   512Kbps
IP CH4	ON	Enable	DualStream	2560x1440   640x480	25Fps   10Fps	2Mbps   512Kbps

View recording *information* for each connected camera such as bitrate, stream type, recording resolution and frame rate (FPS).

5.7.5.4 Network State

Attribute	Value
WAN	
IP Address	172.20.56.62
Subnet Mask	255.255.255.0
Gateway	172.20.56.1
MAC Address	00-23-63-94-A6-C4
IPv6 Address	fe80::223:63ff:fe94:a6c4::64
IPv6 Gateway	fe80::64
DHCP	Enable
DNS1	172.18.1.222
DNS2	8.8.8.8
PPPoE	Disable
Port	
Http/Https/RTSP	80.80 Inactive Disable
Client	9000.9000 Inactive Disable
Total Band Width	128Mbps
Used Band Width	55.5Mbps

View network *information*.

**Total Band Width:** It shows the DVR's total input band width for IP cameras.  
**Used Band Width:** It shows the used band width of IP cameras.



### Chapter 6: AI scenario-based application

AI scene application function you real real view of the face attendance, more intuitive and convenient to view the real situation

#### 6.1 Face attendance

Face attendance scene screen full screen display, can record real-time face attendance, real-time view attendance results

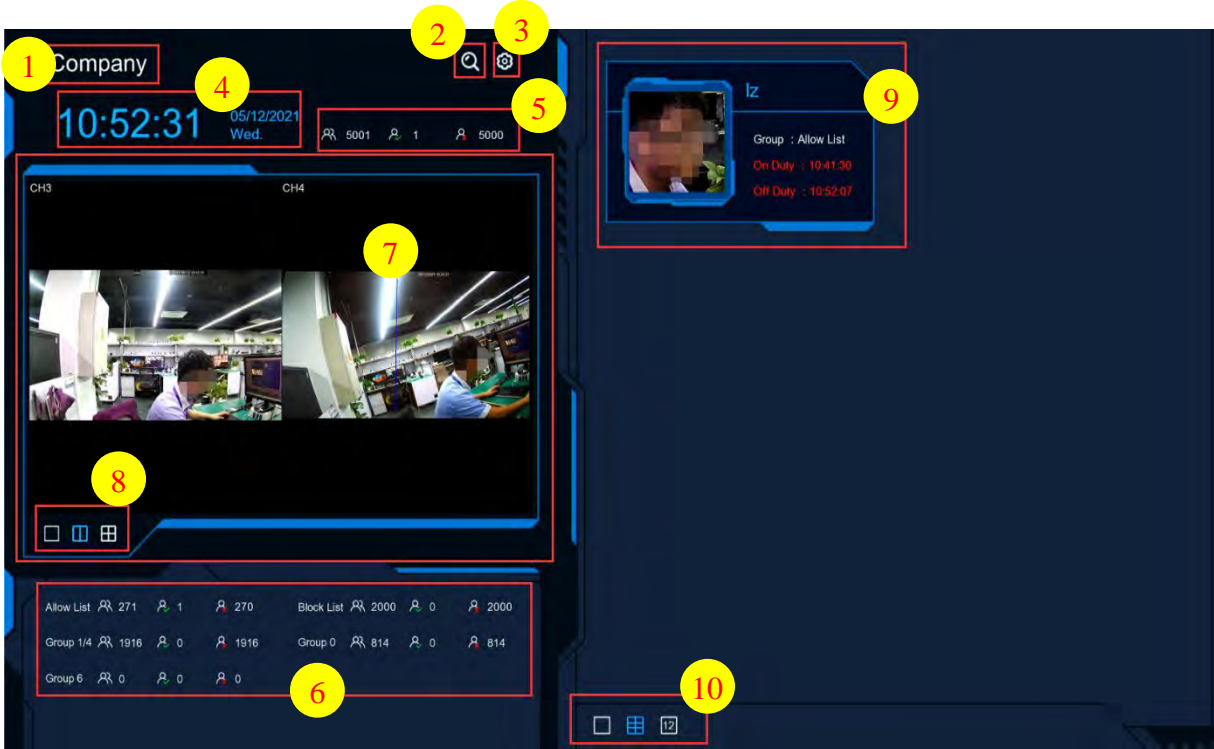

1. Interface theme of face attendance

2. Click  to enter the playback face attendance search interface, and select the face pictures in the face group by default



3. Click  to enter the setup interface.



**Channels:** Channel selection, you can select the attendance channel

**Groups:** Select the faces of those face library for attendance, and click  on the right to pop up to the AI database management settings interface.

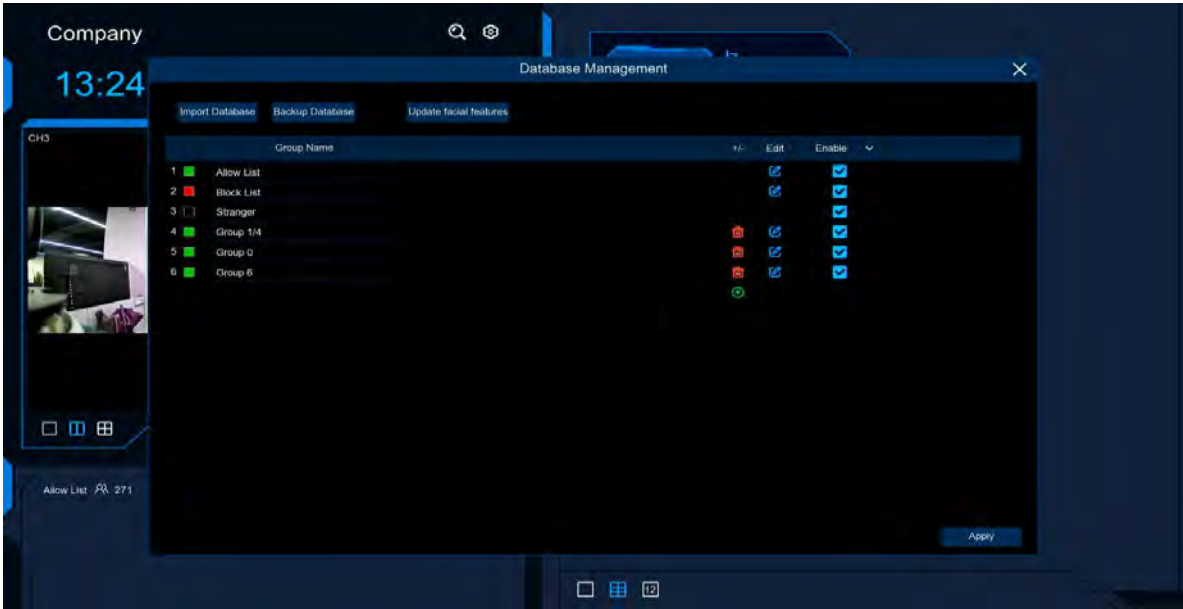

**GUI Theme:** Main interface diagram

**On Duty Time:** Set up the working hours

**Off Duty Time:** Set up the closing time

**Email Configuration:** Face attendance result send email configuration, click  to send face attendance result email configuration

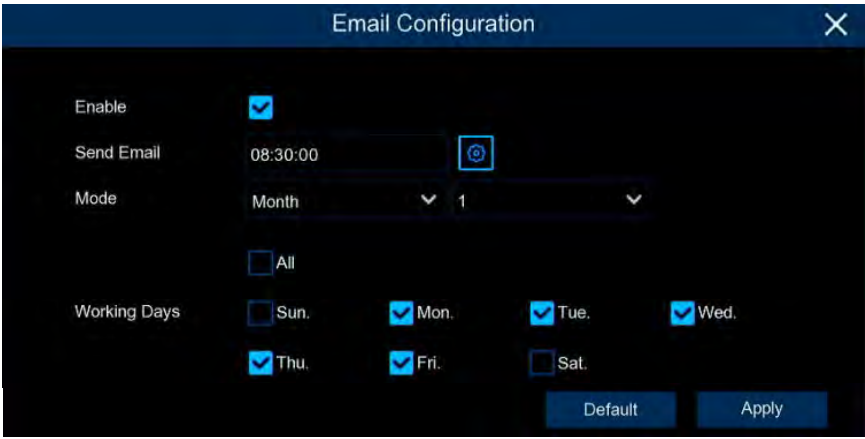

**Enable:** Open the email to send face attendance results (the attendance result is a form file)

**Send Email:** Set the time of sending face attendance result email, click  the pop-up system mail setting interface on the right side of the sending time to configure the system email. The specific configuration can see [5.5.3.1 Email Configuration](#)

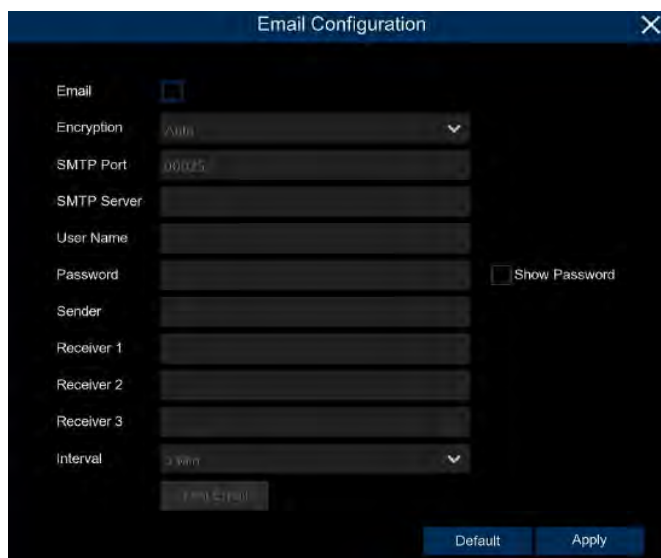

**Mode:** The mode of sending face attendance results, including Day, Week, and Month

**Day:** Send it once a day, send it to yesterday's face attendance results



**Week:** send once a week, you can choose weekly send sent face attendance results for the email time forward a week, such as:

When an email is sent on Monday, the attendance record is sent on last Monday and last Sunday

When sending an email on Tuesday, the attendance record is last Tuesday to Monday



**Month:** Send it once a month. You can choose to send the email one month later, such as:

If an email is sent on the 10th of each month, the attendance record is sent from the 10th of last month to the 9th of this month

That is, if the email is sent on May 10th, the attendance record sent is the attendance record from April 10th to May 9th

**Working Days:** Select a working day, check All, every day is a working day

**Apply:** Click on Apply to save the settings

**Default:** Send the attendance mail settings to restore the default

1. Displays the current date and time
2. Current total number of people attendance situation



 Total number of attendance attendance required

 Number of attendance



 No attendance

3. The attendance status of each face group

4. Channel diagram,  can be selected in the Channels inside the diagram channel

5. Select the number of graph windows with one  , two  four  windows

6. Face real-time attendance push, display attendance face picture, name, from the group name, work attendance time and off-work attendance time

7. The interface also displays the maximum number of face attendance pushes, with 1  , 6  and 12 

## 6.2 CC scenario

This is an AI application based on cross-count functions that helps control the attendance of customers / visitors / vehicles in public places such as restaurants, parks, zoos, theaters, museums, parking lots.

### 6.2.1 channel

Count and view real-time results through a single camera. Mainly used for small places with single entrances and exits.

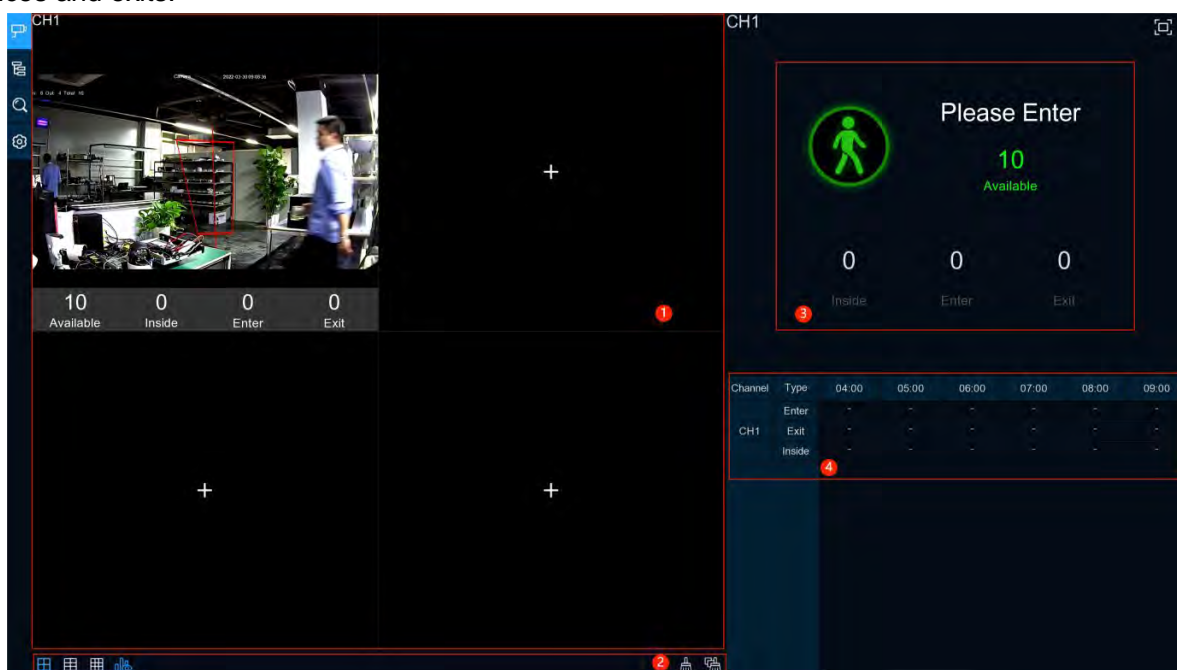

1. Channel drawing and real-time line crossing statistical data, the drawing channel can be selected in the Channels in the Settings 









**Available:** Number of presence allowed remaining

**Inside:** Current existing quantity in the control area

**Enter:** Number of the entries recorded

**Exit:** Number of exits recorded

2. Select the number of drawing windows with 4 windows  , 6  , 9  ; click  to display / hide the statistics under the channel; click  to clear the current selected channel statistics, and click  to clear all the channel statistics.

3. Real-time count data information, click  to display the total statistics on the full screen.

4. Data and exit information of each channel and each time period.



### 6.2.2 Groups

Statistics and view real-time results by group. It is mainly used in large places with multi-channel entrances and is monitored by multi-channel cameras.

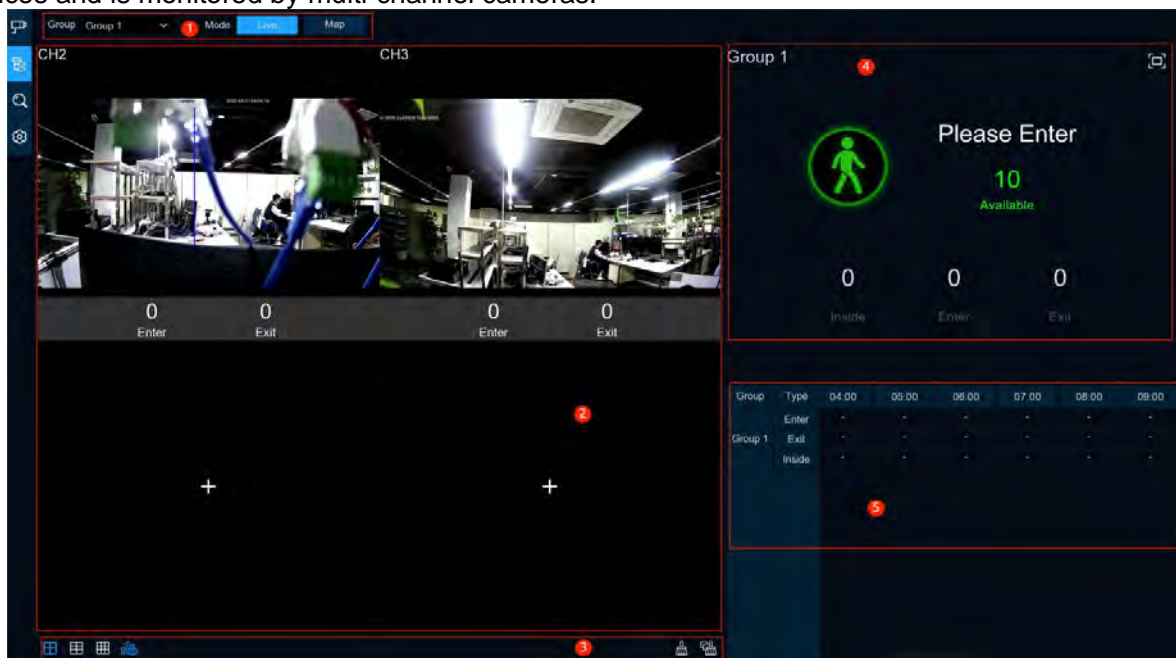

1. Group can select the group information to display, Live displays the channel preview screen and statistics information, and Map displays the map information;



2. Channel drawing and real-time line crossing statistical data, you can select each group drawing channel in the Group in the Settings 



Enter: Number of the entries recorded

Exit: Number of exits recorded

2. Select the number of drawing windows with 4 windows  , 6  , 9  ; click  to display / hide



the statistics under the channel; click  to clear the current selected channel statistics, and click  to clear all the channel statistics.

3. Real-time count data information, click  to display the total statistics on the full screen.

Available: Number of presence allowed remaining

Inside: Current existing quantity in the control area

4. Data entry and exit information of each group and each time period.  
(graph 2)

5. Map information configuration, click  to add a map picture, click  to set the position of the IPC diagram on the map, and click  to display the map information and the line crossing statistics of the current group on the full screen

6.2.3 Search



You can search for channels and groups separately. Select the channel or group that you want to search for, set the search duration by day, week, month, or year, and select the type of target that you want to search for. Click the search icon and the results appear on the right side of the window.

6.2.4 Settings

Configuration settings

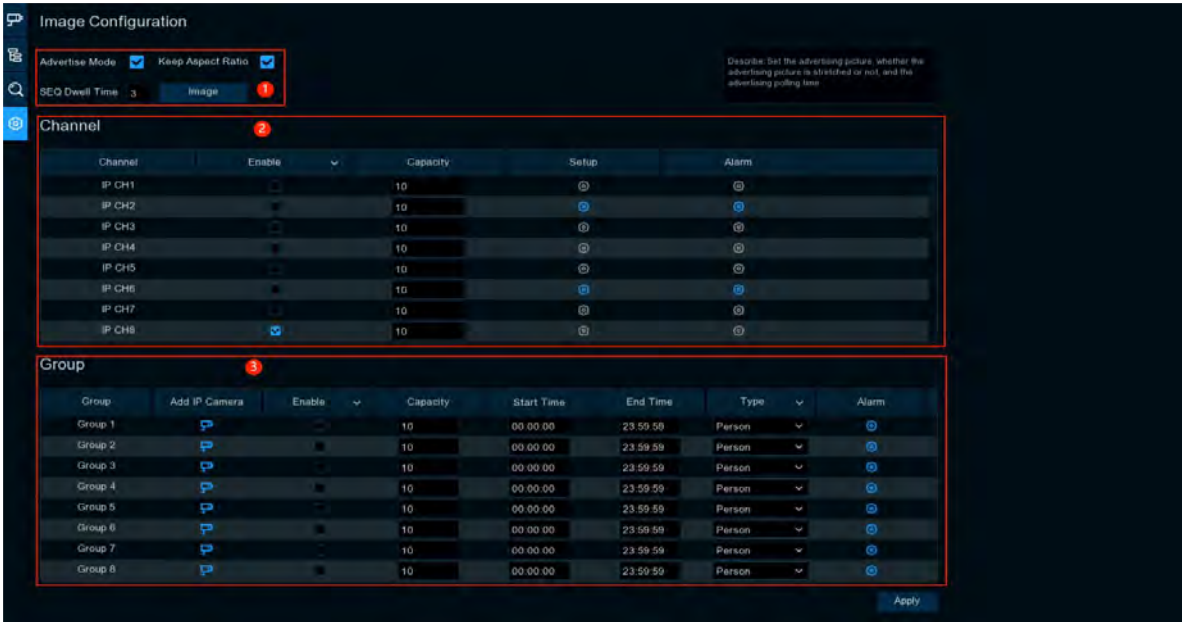



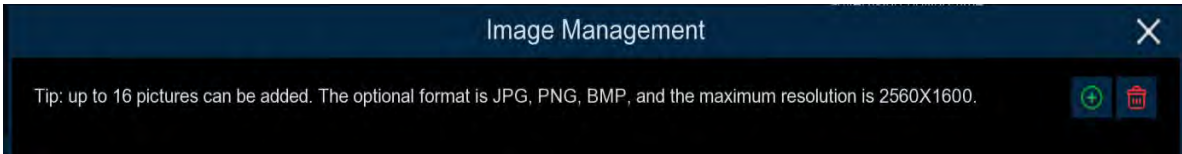

1. Check the **Advertise mode** to open ad mode; set the SEQ residence time in seconds, which determines the time each image stays on the screen, by default to 3 seconds. Click the **Image** button to load ad pictures from USB memory supporting a maximum of 16 jpg, png and bmp images with a resolution of no more than 2560x1600.



Click  Add New Picture, and click  Delete Add Picture one by one.

Check the **Keep Aspect Ratio** box if you want to display an image with the original aspect ratio; uncheck the box if you want the image to be stretched and full screen. Return to Channel View Mode or Group View Mode, click the full screen button in the upper right corner to display your ad picture and real-time count data for the selected channel or group.

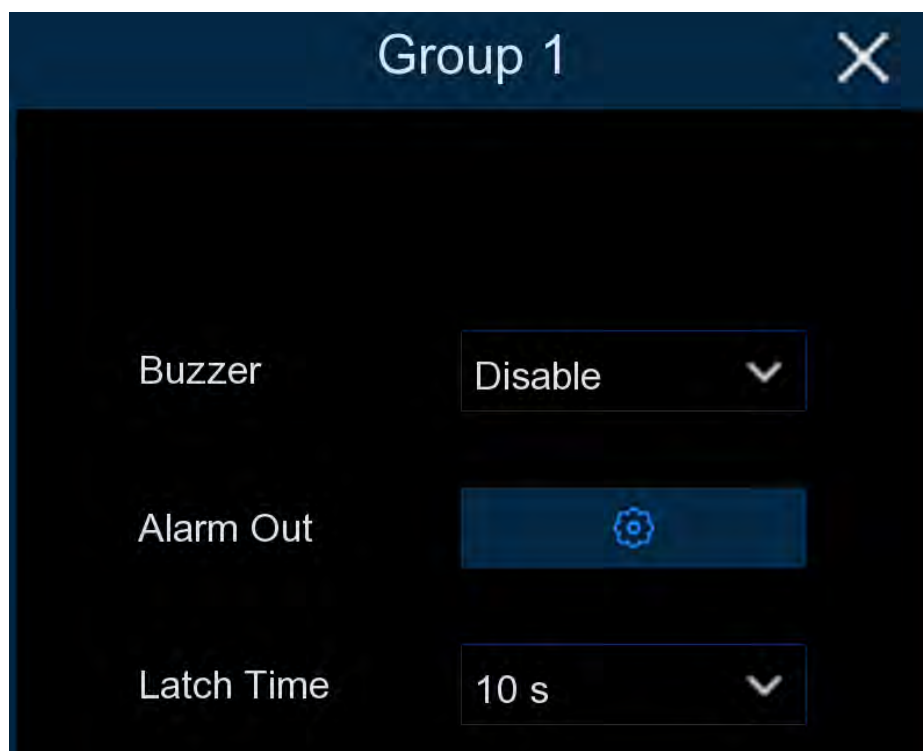

2. The Set **Enable** enabling box selects which channels to display on the channel page. Then the Setup and Alarm icons ; will be blue if the camera in the channel supports AI functionality; instead, if the camera does not support AI functionality, the icon will be gray . Set the **Capacity** for each channel, which is the maximum limit for attendance. Click  click the configuration detection condition, Click **Alarm**  to enter the alarm action when the number is 0.



**Buzzer:** Set the buzzer duration in seconds when the available number is 0.

**Alarm Out:** If your DVR supports a connection to an external alarm device, you can set the alarm sound.

**Latch Time:** Configure the external alarm time when the available number is 0.

3. Click  to add the channel to the group. Up to eight groups can be set, but only one group can be added to each channel. If a channel is enabled in Channel view mode, it is not allowed to be added to any groups. Select the **Enable** box to activate the group. You can set the number of **Capacity** per group, **Start Time**, **End Time**, **detection types** (Person, Vehicle, and Motion). Click  the configuration of Alarm to enter the alarm action when the number is 0.

### 6.3 Non-human machine statistics

Face, human shape, motor vehicle, non-motor vehicle detection scene interface full screen display, can view the detection results in real time.

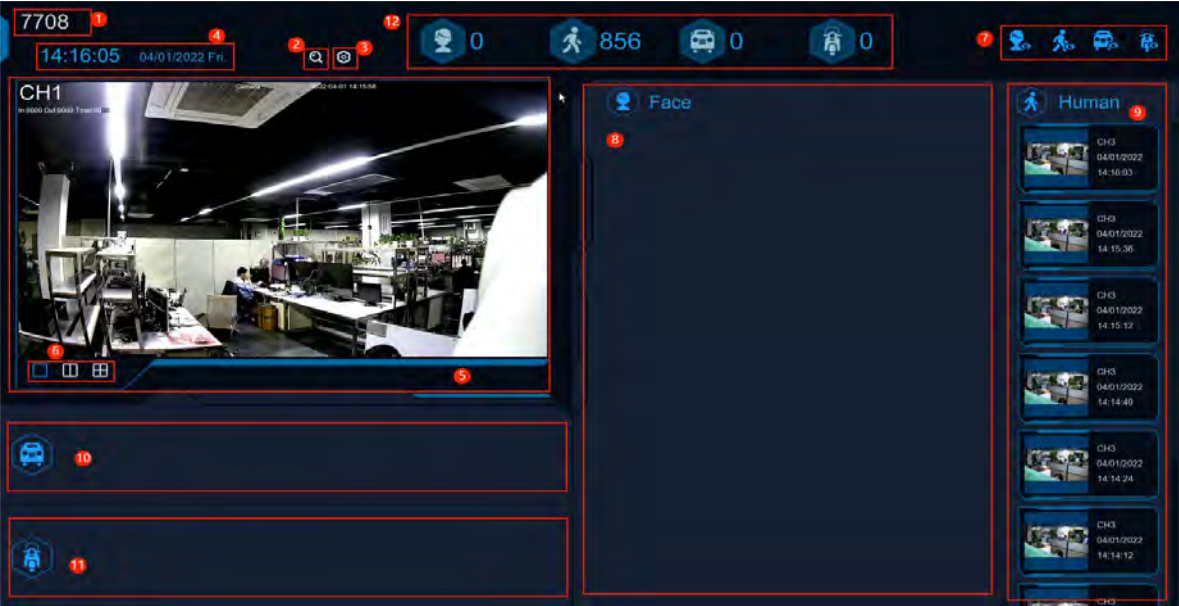

1. Interface theme of machine and non-human statistics

2. Click  to enter the playback humanoid model search interface.

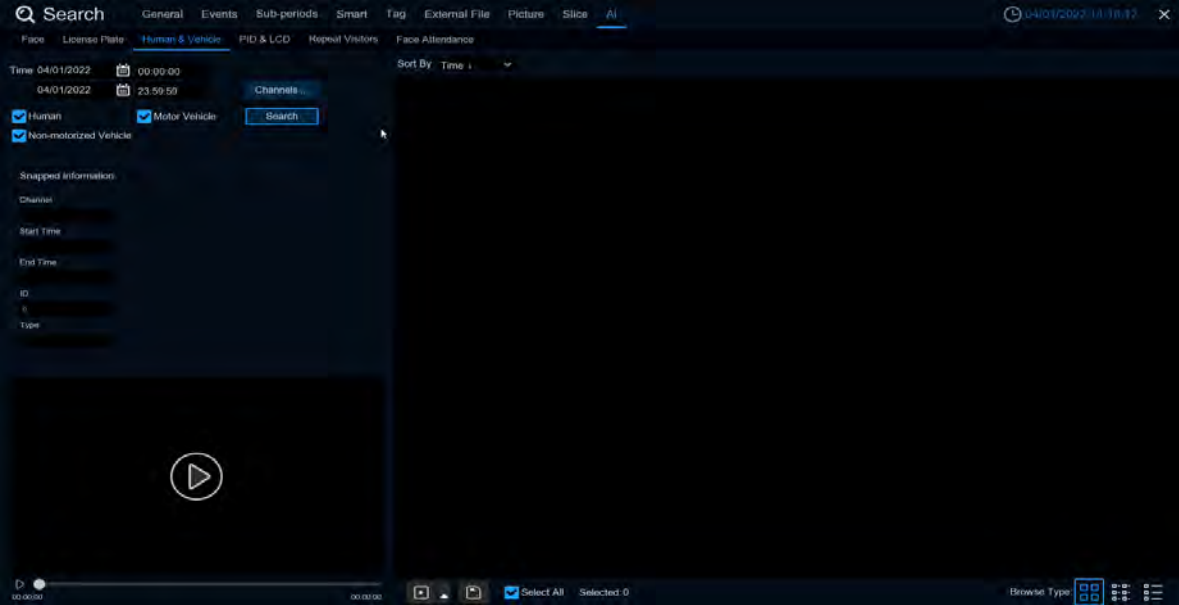

3. Click  to enter the setting interface.

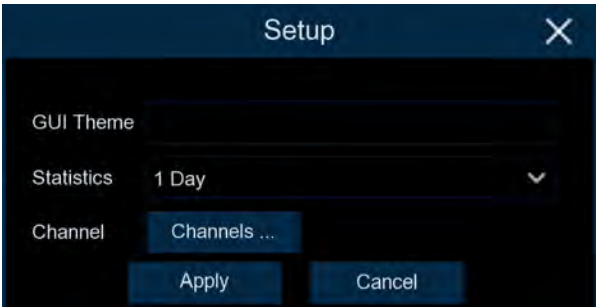



**GUI Theme:** The interface theme

**Statistics:** Statistical time, you can choose 1 day, 2 days, 3 days, 4 days, 5 days, 6 days, 7 days, week, month and year.

**Channels:** Channel selection, you can select the statistical channel

4. Show the current date and time

5. Channel diagram, you can select the diagram channel in 

6. Select the number of drawing Windows, with 1 , 2  and 4  windows

7. Real-time push display switch, and click the icon to display / hide the corresponding detection results for real-time push

8. Real-time push of face detection, showing the detected face picture, name, and incoming group name.

9. Real-time push of humanoid detection, showing the detected humanoid pictures, detection channels and detection time

10. Real-time push of motor vehicle type detection, and display the detected motor vehicle pictures, detection channels and detection time

11. Real-time push of non-motor vehicle testing, display the detected non-motor vehicle pictures, detection channels and detection time

12. Statistics of the number of human faces, human shapes, vehicle models and non-motor vehicles captured.

### Chapter 7 Search, Playback & Backup

The Search function gives you the ability to search for and play previously recorded videos as well as snapshots that are stored on your DVR's hard drive. You have the choice of playing video that matches your recording schedule, manual recordings or motion events only. The Backup function gives you the ability to save important events (both video and snapshots) to a USB flash drive.

#### 7.1 Using Search Function

Click  **Search** button in the Start Menu to enter search section.

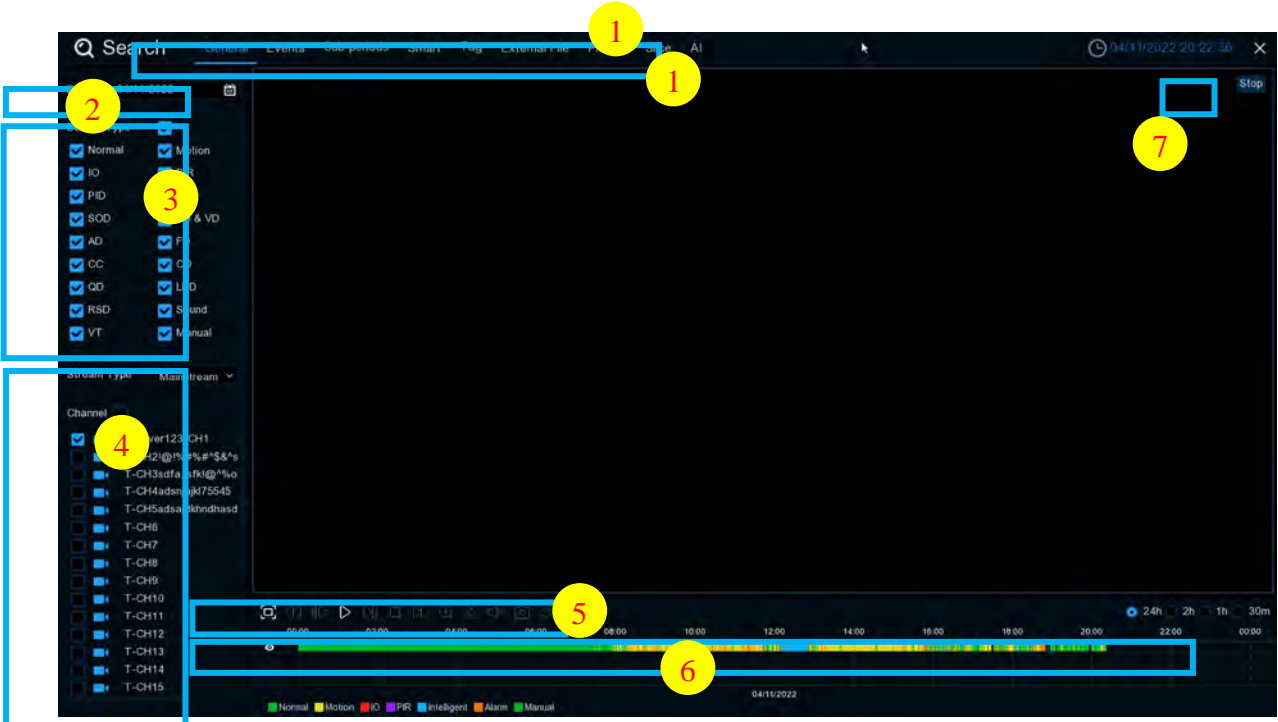

1. **Search Options:** the system provides various search & playback methods: General, Events, Sub-periods, Smart & Pictures
2. **Search Date:** search by a date to play back.
3. **Search Type:** the system provides different search types to narrow your search.
4. **Channel Selection:** to choose the channels you want to search & play.
5. **Video Playback Controls:** to control the video playback.



 Enlarge the video playback to full screen

 Rewind, x2, x4, x8 and x16

 Slow Play, 1/2, 1/4 and 1/8, 1/16 speed

 Play

 Pause

 Play frame by frame. Click once to play a frame of the video

 Stop



 Fast Forward, x2, x4, x8 and x16

 Digital Zoom: Click to zoom in then click-and-drag on a camera image during playback to zoom in on the selected area. Right-click to return to regular playback.

 Video Clip. Quickly save a section of video to a USB flash drive. View more on [7.1.1.1 Video Clip Backup](#)

 Save Video Clip.

 Volume Control: scroll the slider bar to increase or decrease volume.

 Snapshots: to capture a snapshot image to your USB flash drive. If the video playback is in split-screen view, move the mouse cursor to the channel you want to capture, and then click the  icon to save the snapshot.

 Add default bookmark

 Add custom bookmarks

 Single machine to switch between raw scale screen or stretch screen.

6. **Timeline:** Continuous recordings are shown with colored bars to represent different types of recording (legend shown in the bottom-right corner of the display). Use the timeframe options () to view a smaller or larger time period.

**Different types of recording shown in different colors:**



Continuous Recording in **Green** color;

Motion Recording in **Yellow** color;

I/O Recording in **Red** color;

Motion & I/O Recording in **Orange** color;

Intelligent Recording in **Blue** color;





PIR Recording in **Purple** color;

7. **Playback Status**: display the video play status.

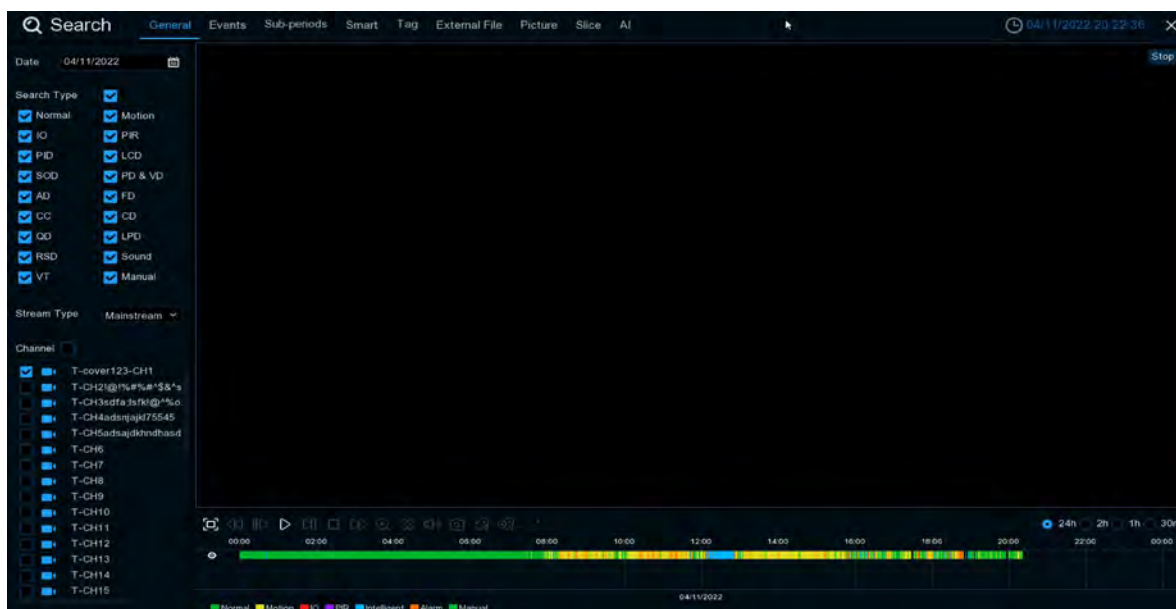

### 7.1.1 Search & Play Video in General

This menu gives an option to search & play recording for a selected date







1. Select a date icon  to search for video recording from the calendar.
2. Choose a search type.
3. Check channels you would like to search, or check **Channel** to search all connected channels.
4. The search result will display on the timeline from 00:00 to 24:00.
5. Click  button to start playback.
6. Control the playback with buttons on **Video Playback Controls**.
7. Use the timeframe options ( 24h  1h ) to view a smaller or larger time period.

8. If you want to quickly save a section of video during playing back to a USB flash drive, use the **Video Clip** backup function. 

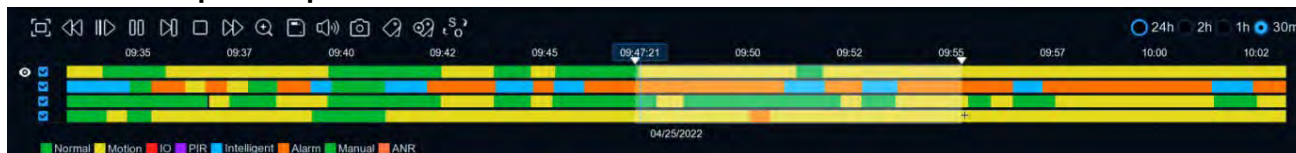
9. Add label function, click  Add custom label, click  Add default label, you can make a mark in the current time of the current channel. After the label is added, you can play back the label on the label playback interface.

#### 7.1.1.1 Video Clip Backup



1. Insert your USB flash drive to the DVR.
2. Start a video recording playback.
3. Click .
4. Check the channel(s) you want to make a video clip backup.
5. Move the mouse cursor to the timeline where you want to start the video clip.
6. Press and hold the left button of your mouse, and drag the drag the cursor to the timeline where you want to end the video clip.
7. The  icon has been changed to  icon, click  to save the video clip.

8. Select a file type for your backup files, click **Save** button to save the video clips. Please make sure your USB driver has enough space to save the video clips.

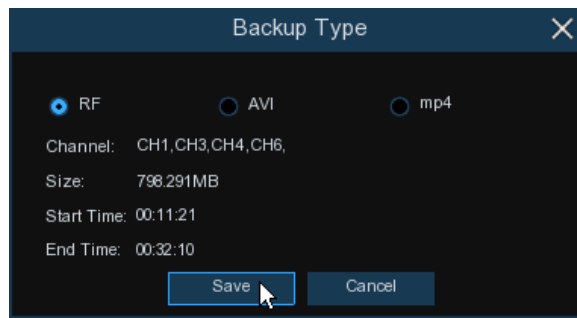

9. The backup drive menu appears. Navigate to the folder you want the backup files to save in.
10. Click **OK** to begin. The progress bar at the bottom of the window shows you the progress of the backup.

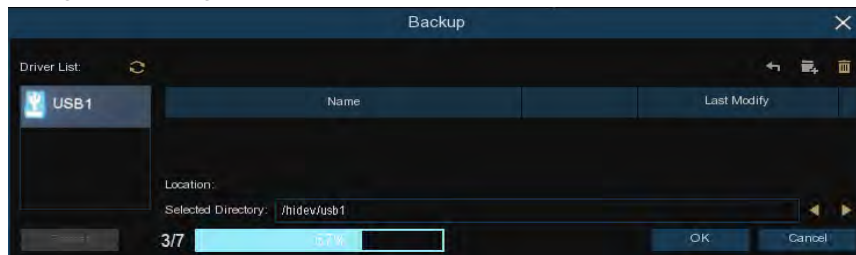

### 7.1.2 Event Search, Playback & Backup

Event search lets you view a list of video recordings with the channel, start and end time, and recording type conveniently summarized. You can also quickly back up events to a USB flash drive.

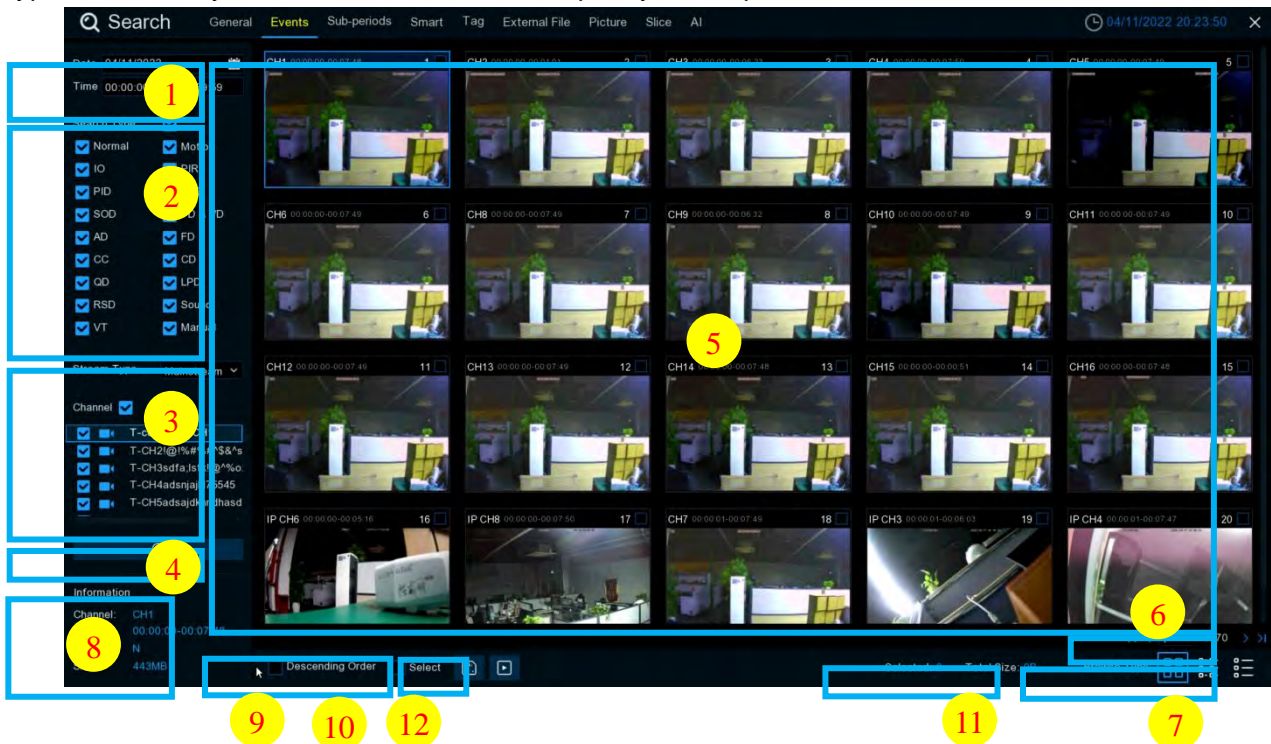

#### To search, play & back up for events:

1. Choose the date & time you want to search.
2. Check the recording types you want to search, or check **Search Type** to choose all.
3. Choose the channels you want to search, or check **Channel** to choose all channels.
4. Click **🔍** icon to start search.
5. Events fitting your search criteria are displayed in list form. You can double click the left button of your mouse upon one of the events to play the video immediately.



6. Click **◀ < 4 /15 > ▶** icons in the bottom-right corner of the menu to browse between pages of events, or input the page you want to browse.

7. You can switch the view of list form in by clicking below icons which is show at the right bottom corner of the screen:

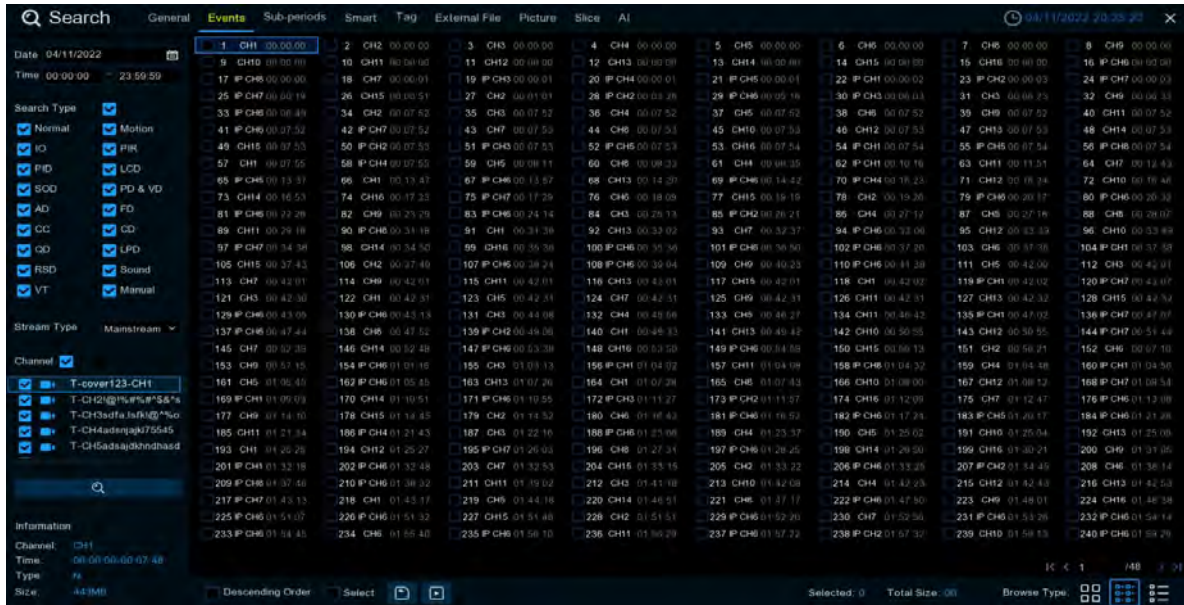

 **Thumbnails view.** You can view the snapshots of the events.

 **List view.** The events will be displayed in list.



 **Detailed view.** You can view the details of the events.





In the detailed view mode, you can lock the video events to keep events from being overwritten in the hard drive. Click the  icon to lock or click  to unlock the events.

8. When you click the left button of your mouse upon one of the event, system will show the event information on the left bottom corner of the screen.

9. Check the box next the number of the event to select files, or check the box next **Select** to select all events in the page.

10. The number of selected files, total size information will be displayed at the right bottom of the screen.

11. After selecting file, you can click  icon to save the video to USB flash drive. Or click  icon into event playback control window to play the video.

### 7.1.2.1 Event Playback Control

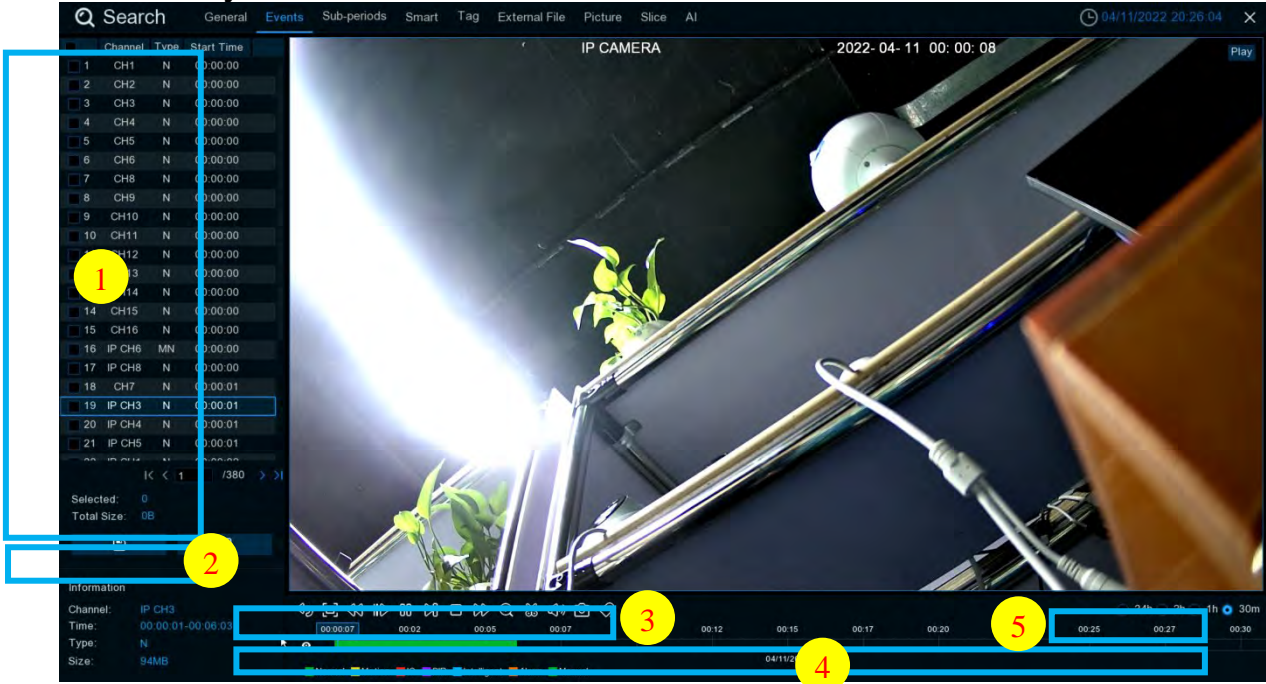

1. Event List, you can select the events here.
2. Click icon to save your selected event videos to USB flash drive. Click icon to play video.
3. Control playback through the icon on the video playback control. You can click the icon or right-click to exit playback and return to the event search window. Add label function, click Add custom label, click Add default label, you can make a mark in the current time of the current channel. After the label is added, you can play back the label on the label playback interface.
4. Click to switch between raw scale screen or stretch screen
5. The event you are playing now will be displayed on the timeline.
6. Use the timeframe options ( 24h  2h  1h  30m) to view a smaller or larger time period.



### 7.1.3 Sub-periods Playback

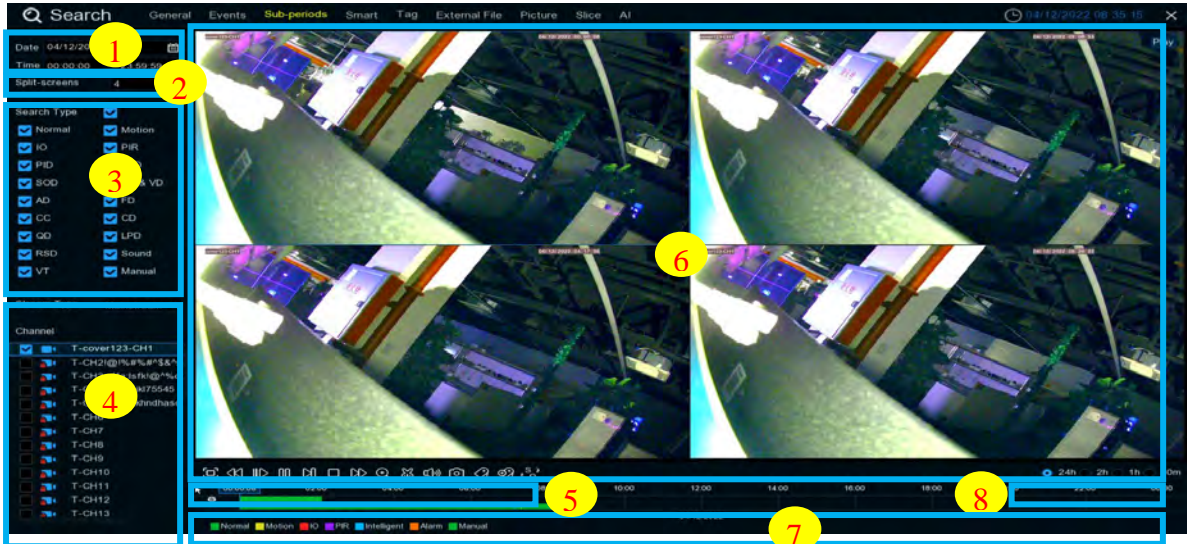

Sub-periods playback allows you to play multiple normal recordings and motion events simultaneously from a single channel. With normal and event recordings, the video is divided evenly depending on the split-screen mode that has been selected. For example, if the video is an hour long and you have selected Split-screens x 4, each split-screen will play for 15 minutes.









**To search & play video in sub-periods:**

1. Click  the date & time you want to search.
2. Choose the date & time you want to search.
3. Choose the split-screens you want the videos to be played in.
4. Check the recording types you want to search, or check **Search Type** to choose all.
7. Click the play button  to start playing. Control the playback with buttons on **Video Playback**

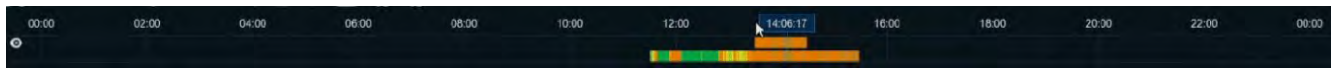
**Controls.** Add label function, click  Add custom label, click  Add default label, you can make a mark in the current time of the current channel. After the label is added, you can play back the label on the label playback interface.

8. Click  to switch between raw scale or stretch screen
9. The video is playing on a split screen.
10. Click the left mouse button on a specific split screen, and the time period of the split screen will be displayed on the timeline. The color bar at the top of the timeline indicates the split screen span of the video that you clicked. The color bar at the bottom of the timeline represents the time span of the entire video you have searched for.



5. Use the timeframe options ( 24h  2h  1h  30m) to view a smaller or larger time period.

**7.1.4 Smart**



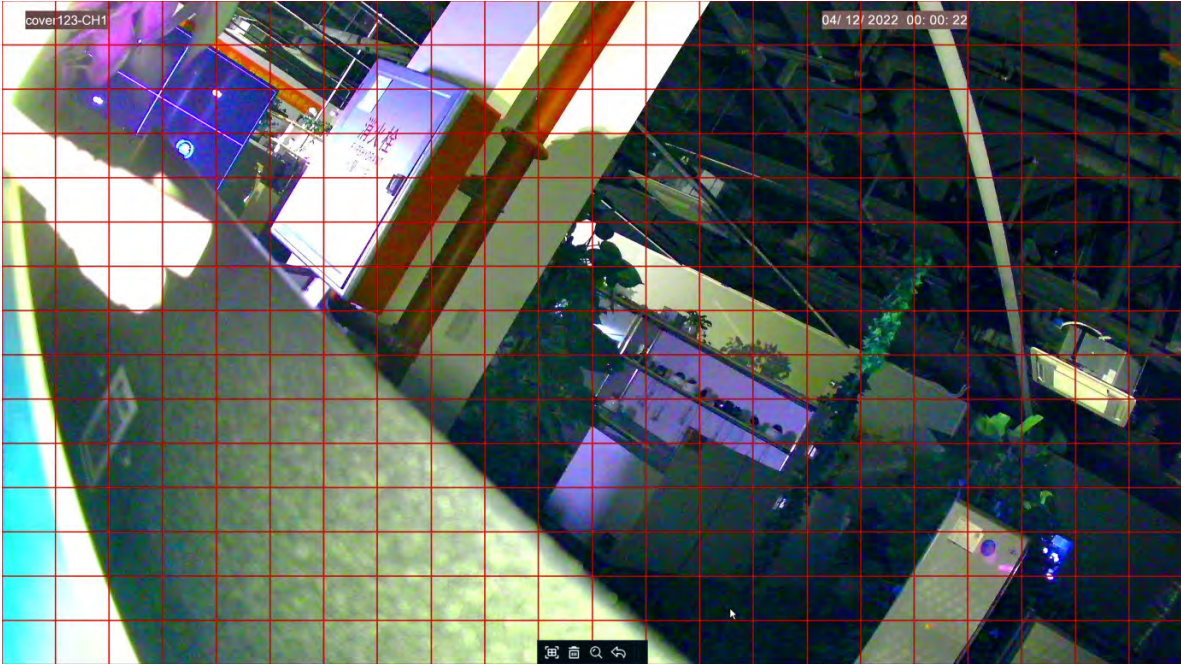

This feature identifies whether the motion is triggered by a human in motion, and if it is, it will appear blue in the play time bar below. Click  to enter the SMART area setting screen,



The red grid is the selected area. If someone in the area triggers the Motion, it will be searched and marked with blue time bar.

### 7.1.5 TAG

Here you can view all the tags you have added and edit, play back, or delete them. Select time and channel click  to complete the search. Click  to skip to the position marked by the label for playback.

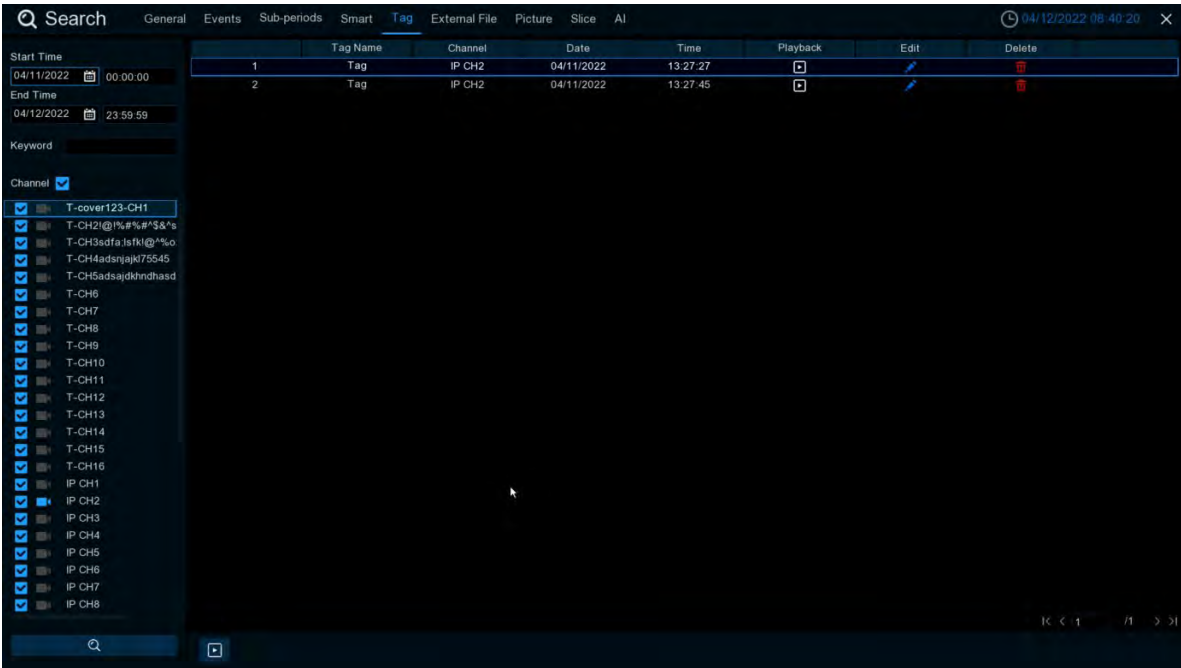



### 7.1.6 External File

This is where you can play video from the external usb drive. Select the file on the left to play it automatically.



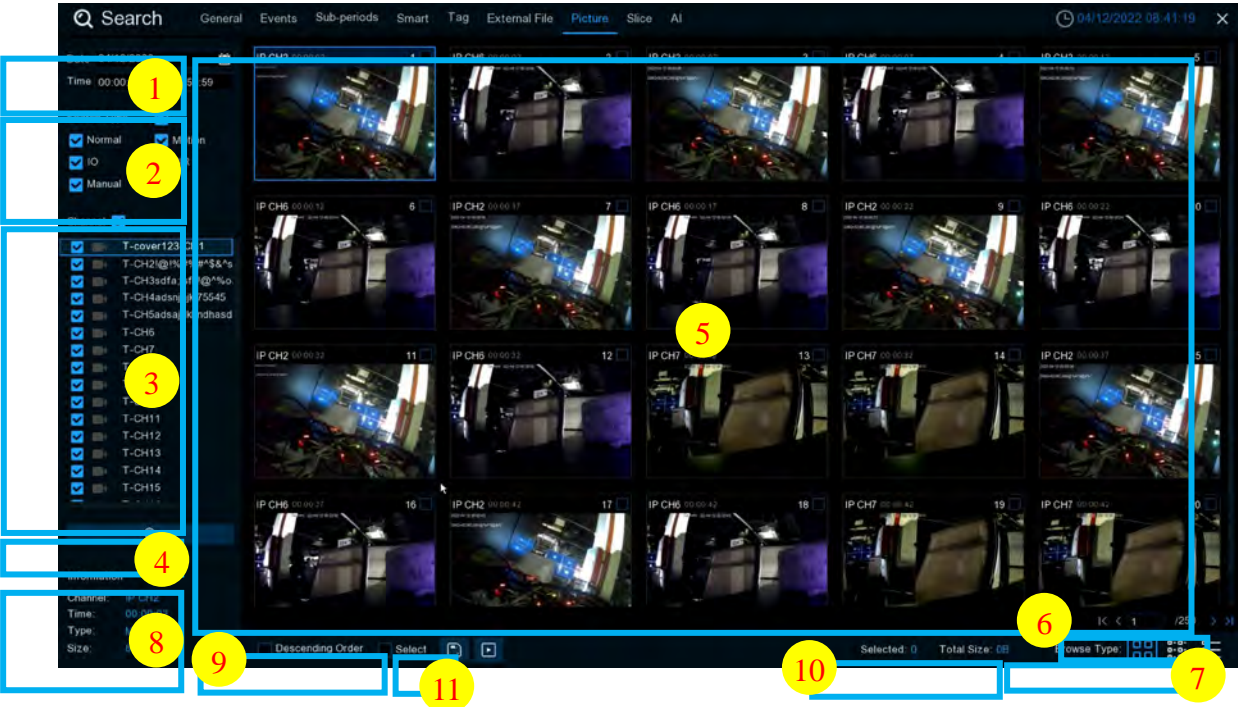

### 7.1.7 Picture Search & View

This function can be used to search, play and copy snapshots to a USB flash drive.



#### To search, play & back up pictures:

1. Choose the icon  you want to search.
2. Check the picture capture types you want to search, or check **Search Type** to choose all.
3. Choose the channels you want to search, or check **Channel** to choose all channels.
4. Click  button to start search.
5. Pictures fitting your search criteria are displayed in list form. You can double click one of the pictures to get a larger view.

6. Click  icons in the bottom-right corner of the menu to browse between pages of pictures, or input the page you want to browse.

7. You can switch the view of list form in by clicking below icons which is show at the right bottom corner of the screen:



Thumbnails view. You can view the snapshots of the events.

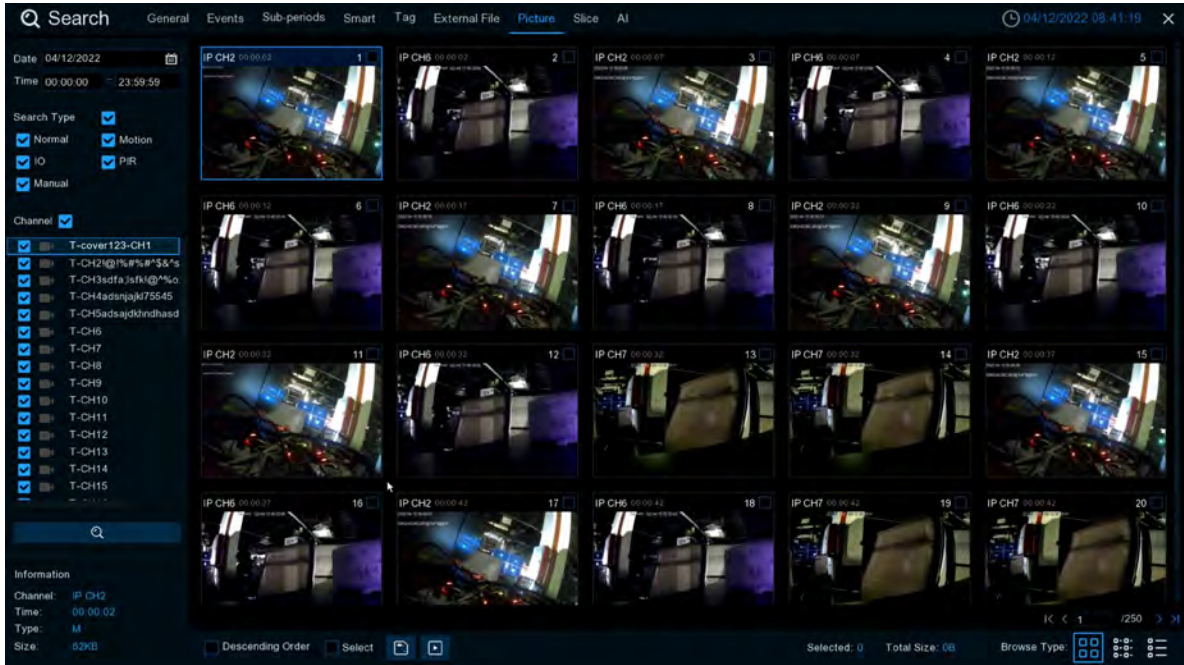

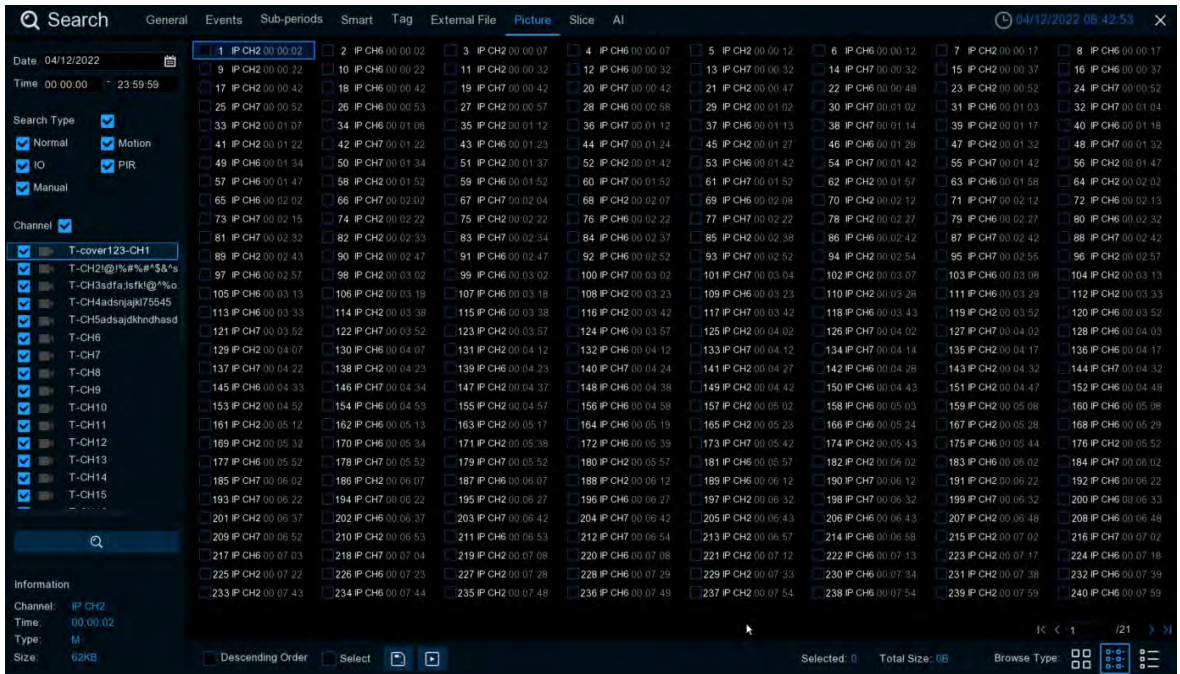

List view: The events will be displayed in list.



Detailed view: You can view the details of the events.

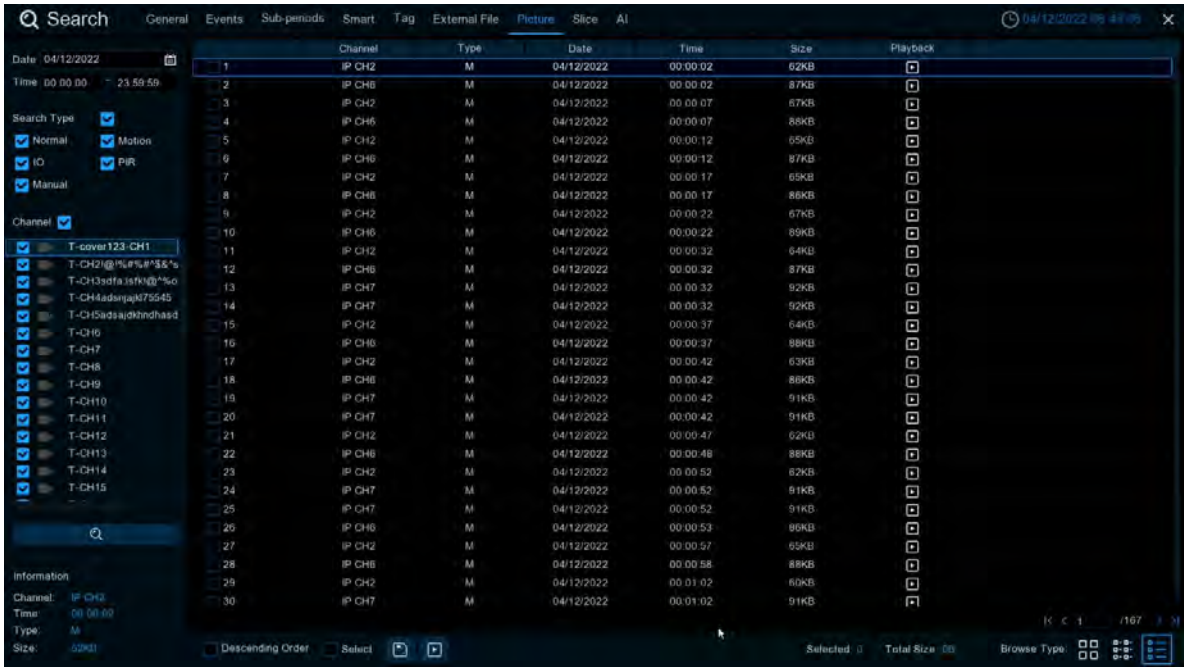







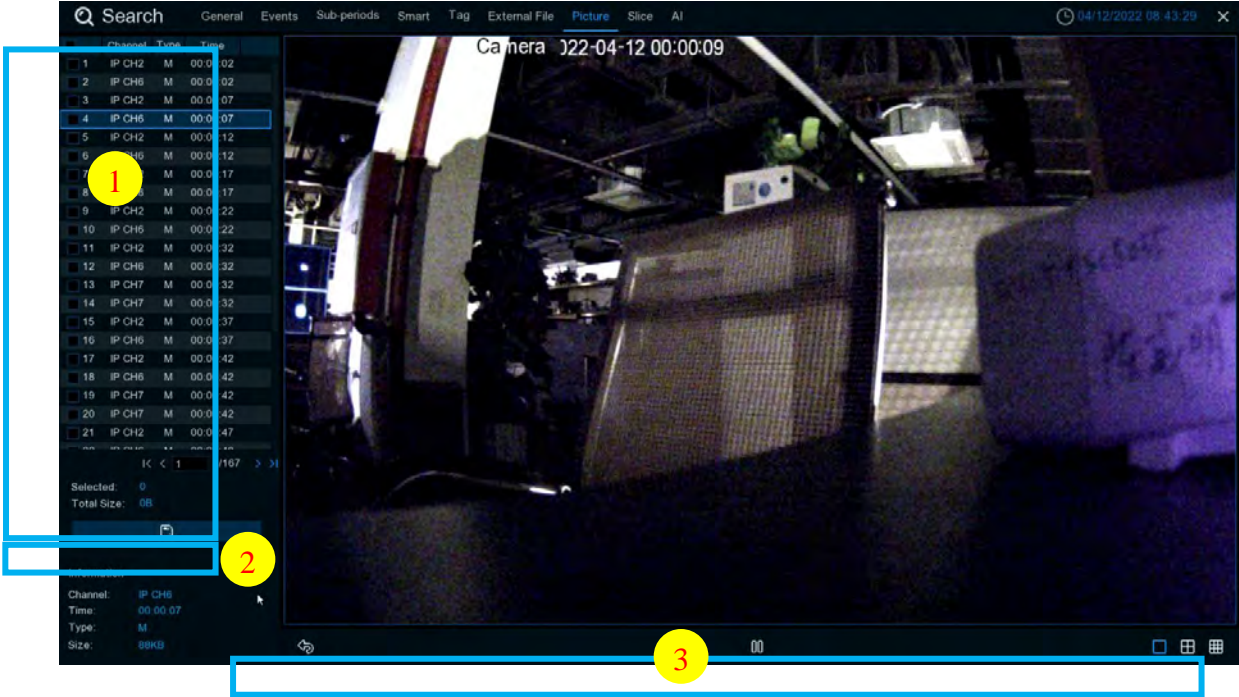





8. When you click the left button of your mouse upon one of the pictures, system will show the picture information on the left bottom corner of the screen.
9. Check the box next the number of the event to select files, or check the box next **Select** to select all pictures in the page.
10. The number of selected files, total size information will be displayed at the right bottom of the screen.
11. After selecting file, you can click  button to save the pictures to USB flash drive. Or click  button to go into picture preview control window.

7.1.1.1 Picture Preview Control



1. Picture List, you can select the pictures here.
2. Click  button to save your selected pictures to a USB flash drive. Click  button to view the pictures in slideshow.
3. Press  button to exit preview control window and go back to picture search window. Press  button to pause, press  to resume slideshow.

Press  button to display previous snapshot or group of snapshots, press  to display the next snapshot or group of snapshots.

Click  button to view a single snapshot at a time, click  button to view four snapshots at a time, press  buttons to view nine snapshots at a time.

### 7.1.8 SPLIT PLAYBACK

Video playback allows you to see 60 minutes of video clips within an hour on a certain day, a certain month, a certain year, with 1 minute for each clip.

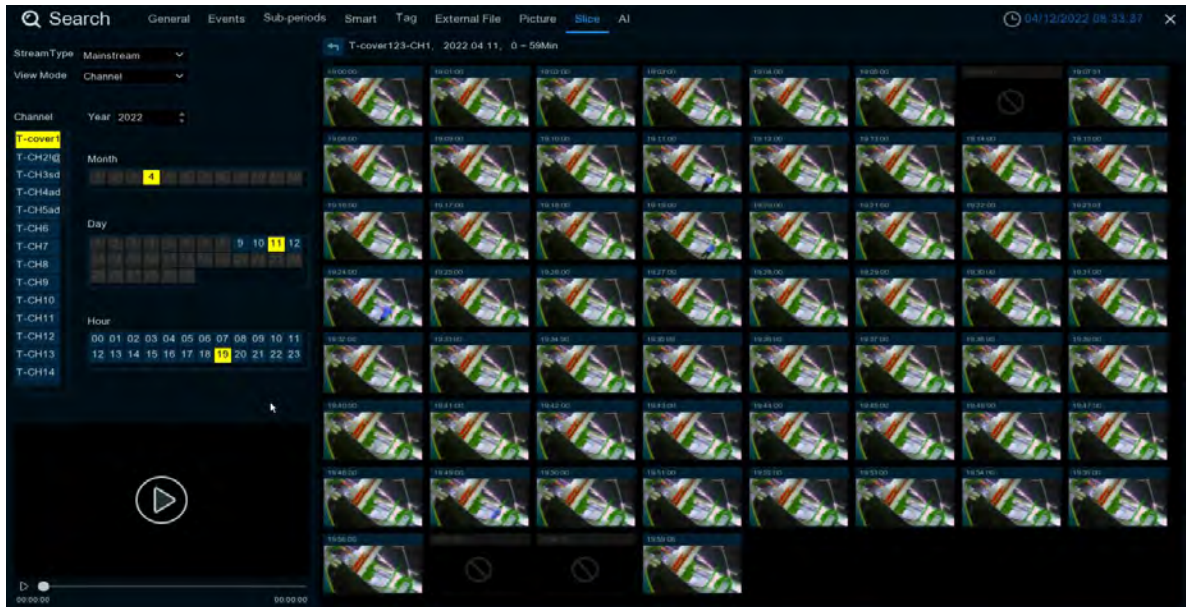

Select the code stream, channel you want to view, month, day, and hour in sequence, and 60 videos within the current hour are displayed on the right side. Each video takes one minute. Click for easy playback in the bottom corner. Click  to enter normal playback. **View mode:** If **Channel** is selected, the previous selection can only be selected first; if **Time** is selected, the previous selection can only be selected first.



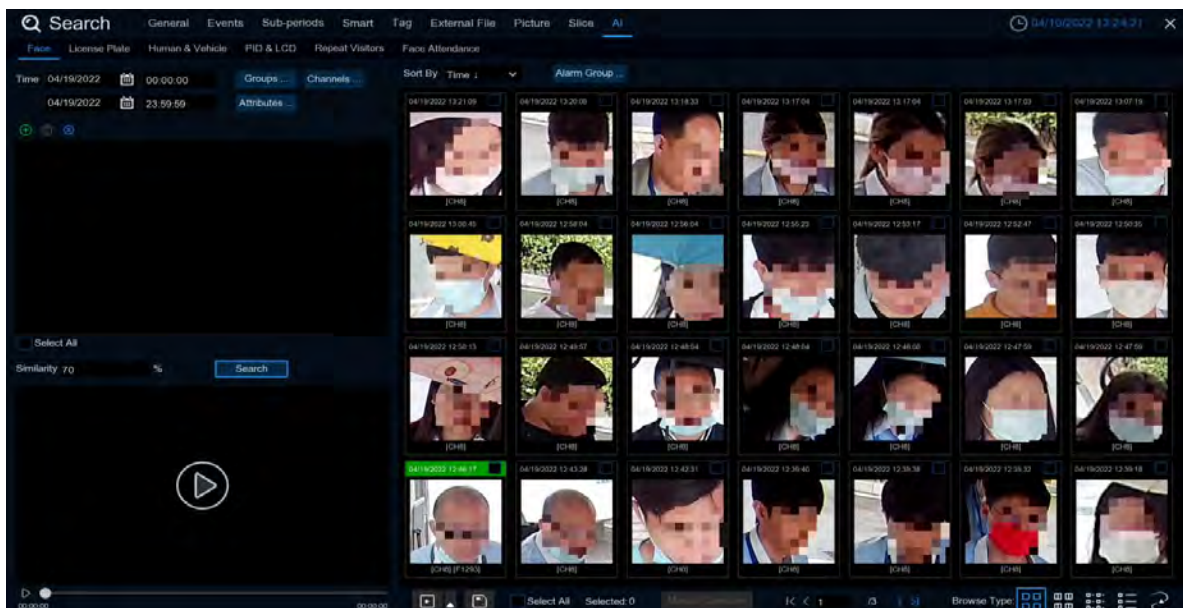

### 7.1.9 AI

#### 7.1.9.1 Face

After selecting the date, time, channel and face group, click search, you can search the face information of the group during this time period.





1. Click  to customize to add the search face. Or choose **Groups** to select the face pictures of the whole group of the face library for comparison search.
2. Click **Channels** on Channels to select the channel for the search
3. Click **Attributes** to set the face attribute conditions for the search, and you can select Gender, aAge, mask Mask, glasses, and Expression
4. Select **Alarm Groups** to select the face group where the face contrast has occurred
5. Select the search area picture  to delete the picture, click  to pop up to the AI face library setting interface
6. Right-select **Import To** in the search results to import this image into the face library grouping
7. Select **Detail Information** in the search results to view the details of the face
8. Click **Custom Playback** to enter the time when the face is detected for playback.
9. Click  to view the different viewing methods.

### 7.1.9.1.1 Face track chart

Click on the lower right corner  to enter the electronic track chart menu.



Click Load Map to pop up the U disk, select Map to add. Check the **Edit** to drag the IPC icon to the location you want to place, uncheck and exit the edit mode. Then click , select the face from the local face library or U disk, click search (only support one face search), you can search out the IPC that has detected the face, there will be a color mark on the map.

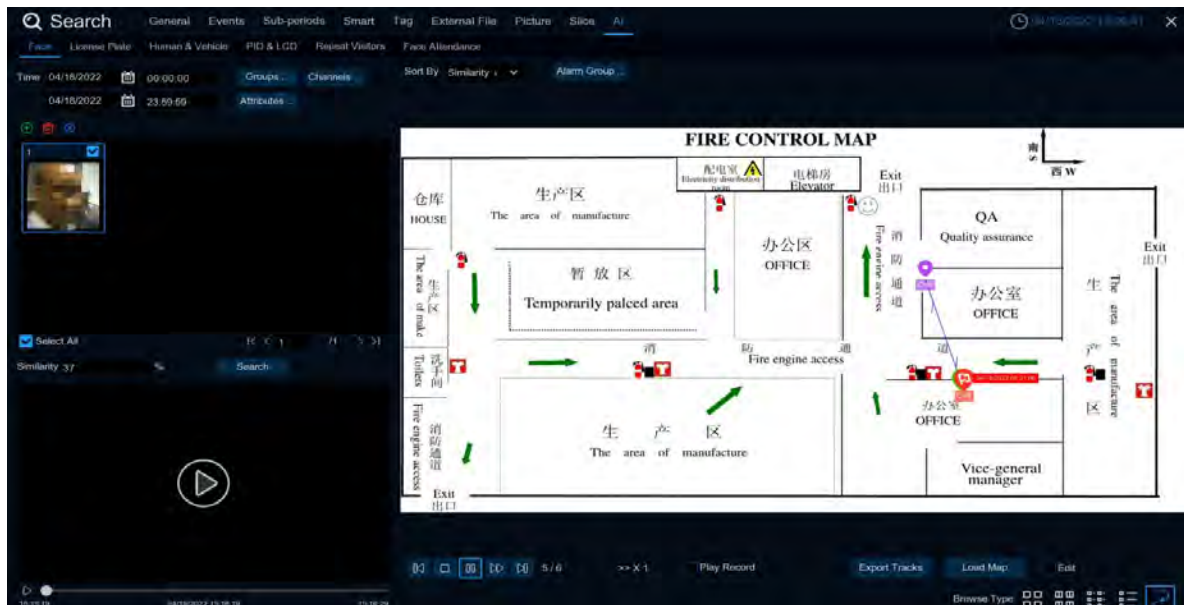

If you click the left button on an IPC icon and play back, there will be a simple playback in the lower right corner. If more than one IPC detects the face, the point playback will automatically judge the person's movement and introduce an arrow.

## 7.1.9.2 License plate detection

If the alarm is triggered and the video is recorded, you can view the video details or export in this interface.

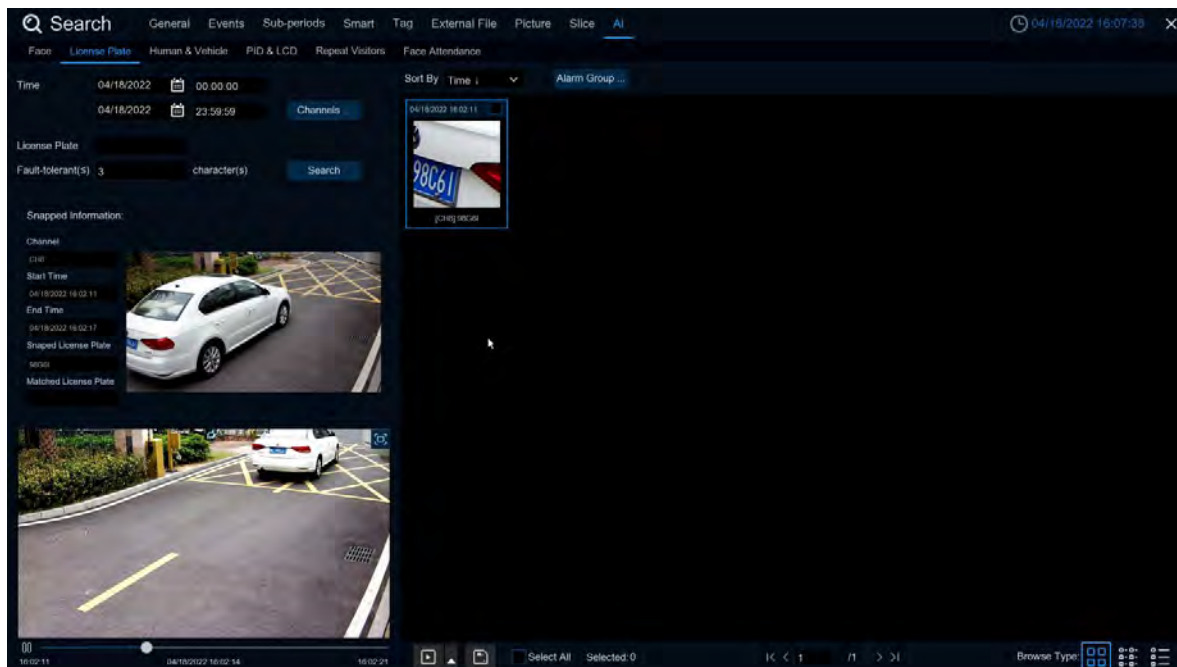

**Time:** Set the time period to query the license plate detection event. Date setting can be set by clicking 

**License Plate:** Screening and query according to the license plate information.

**Fault-tolerant:** Fault tolerance rate, when set to three characters, the white list is B594SB, and also triggered when a B 734KB enters the monitoring area. That is, the detection license plate number has 0~3 characters and the database license plate number is different will be identified.

**Snapped Information:** Details of the alarm events, with the following five items:

**Channel:** Video shooting channel in the event.

**Start Time:** Start time when the event was triggered.

**End Time:** End time when the event was triggered.

**Snaped License Plate:** The license plate number obtained by the camera is captures by taking the license plate photo.

**Matched License Plate:** License plate number obtained from the database.

**Sort By:** Event videos are sorted by time.

**Channels:** License plate detection events triggered by each channel.

**Search:** Query according to the selected settings.

**Alarm Group:** Select the different groups in the database to compare and search for the display results.

 This function is to click the triangle icon in the lower right corner of the event video to select the following delay: 5s, 10s, 20s, 30s, 1min, 2min, 5min, 10min, Custom Playback. If you choose 30s, the video will be extended by 30 seconds each.

 Can backup video to U disk, video format support R F, A VI, M P4 three.

 Select All Selected: 2 All videos are selected and the number of selected videos, respectively.

 Click it to turn over the page.

Click  to select a different way to view it.

Select an event to right-click for two functions:

**Detail information:** View the event details.

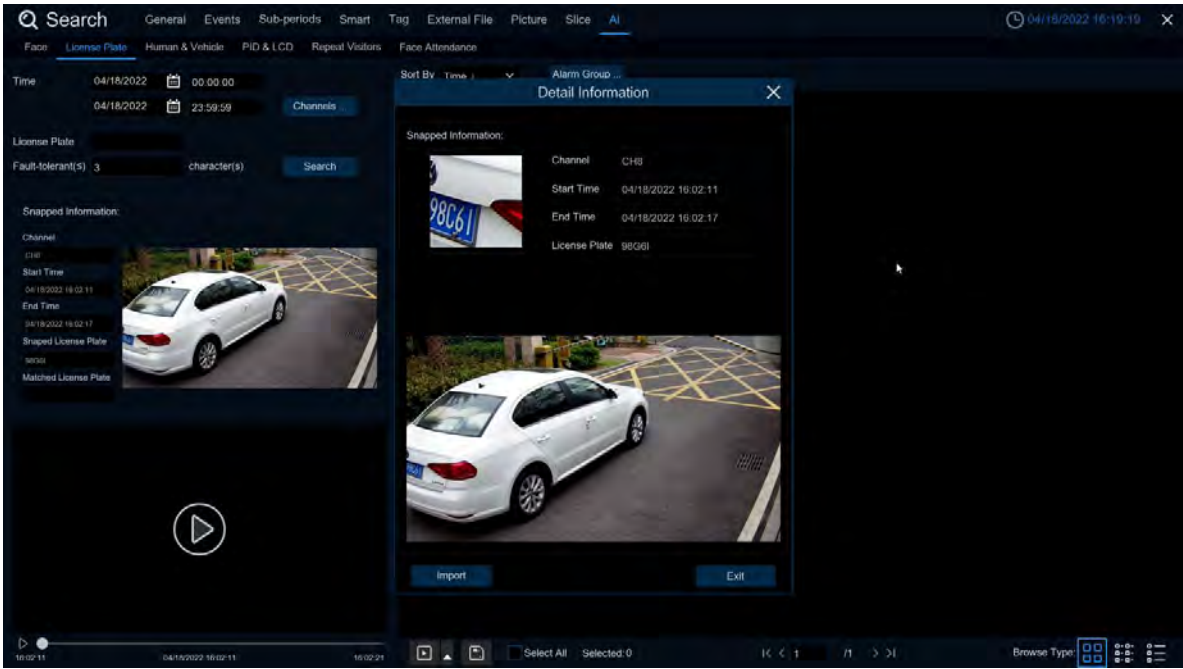

**Custom Playback:** Playback settings, click to set how long the event plays earlier and how long it is delayed. The maximum time limit is 10Min.

Double-click the event or drag to the bottom-left corner to play the event video.

**7.1.9.3 Pedestrian and Vehicle**

After selecting the date, time, channel, and pedestrian and car line type, click search, and you can search for the group owner line and car line information during this time period.

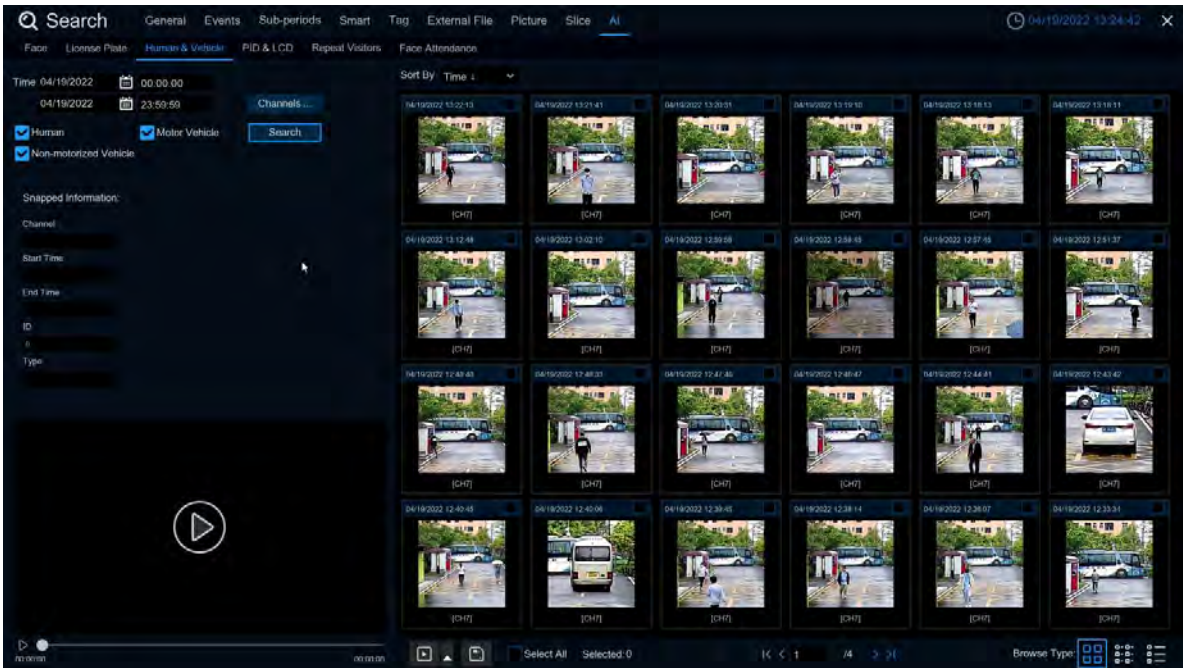

Left click on the left will have basic information, right click to customize playback and view details. Click on the lower left corner to play for simple playback, double-click to enlarge, and enter the normal playback mode.



### 7.1.9.4 PID&LCD

After selecting the date, time, channel and alarm type and person and car type, click search to search for the alarm information for the PID and LCD triggered by all people and car during that time period.

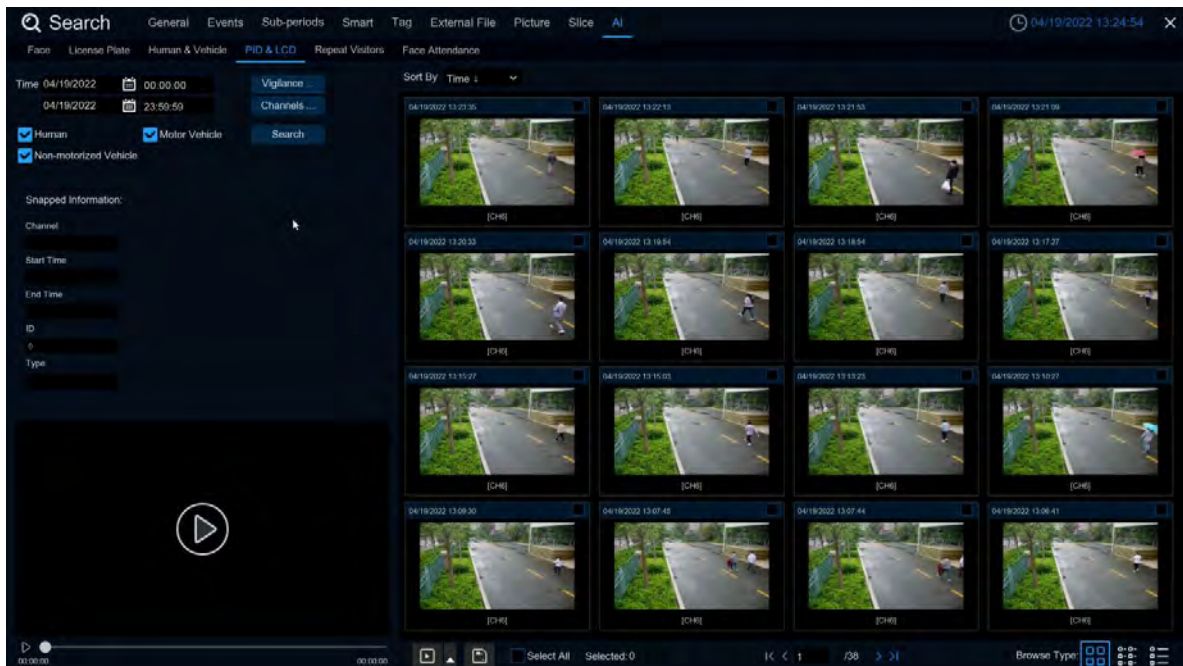

Left click on the left will have basic information, right click to customize playback and view details. Click on the lower left corner to play for simple playback, double-click to enlarge, and enter the normal playback mode.

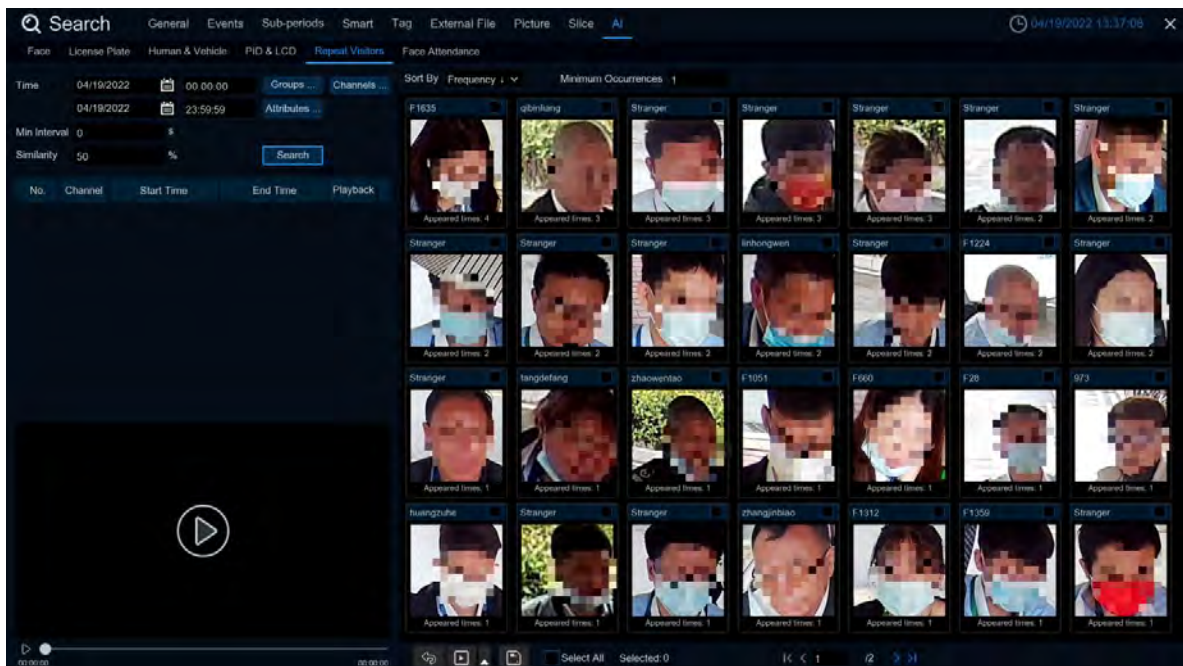

### 7.1.9.5 Repeat Visitors

Here you can search and count all the number of times the same face appears.



1. Select the date and time that you want to search for.
2. Select the face library group you need to compare and search groups by default.
3. Select the channel that you need to search for.
4. Select the corresponding face **attributes** in the attribute interface.
5. Enter the minimum number of seconds separated by the interval.



6. Left click the search results, click the search results, there will be detailed playback and information on the left, right click to import the face library or edit the face library picture information and view the details.
7. Enter the minimum number of face appearances at the Minimum Occurrences for filtering
8. Click **Sort By** to sort, with a rise or fall of time or quantity
9. Check the search results or click on All to select the full search results, click  to customize the play or click  on the backup of pictures and video to the USB flash drive

### 7.1.9.6 Face attendance

The attendance system allows you to check if someone appears at the specified time. And automatically determine whether they are late or leave early.

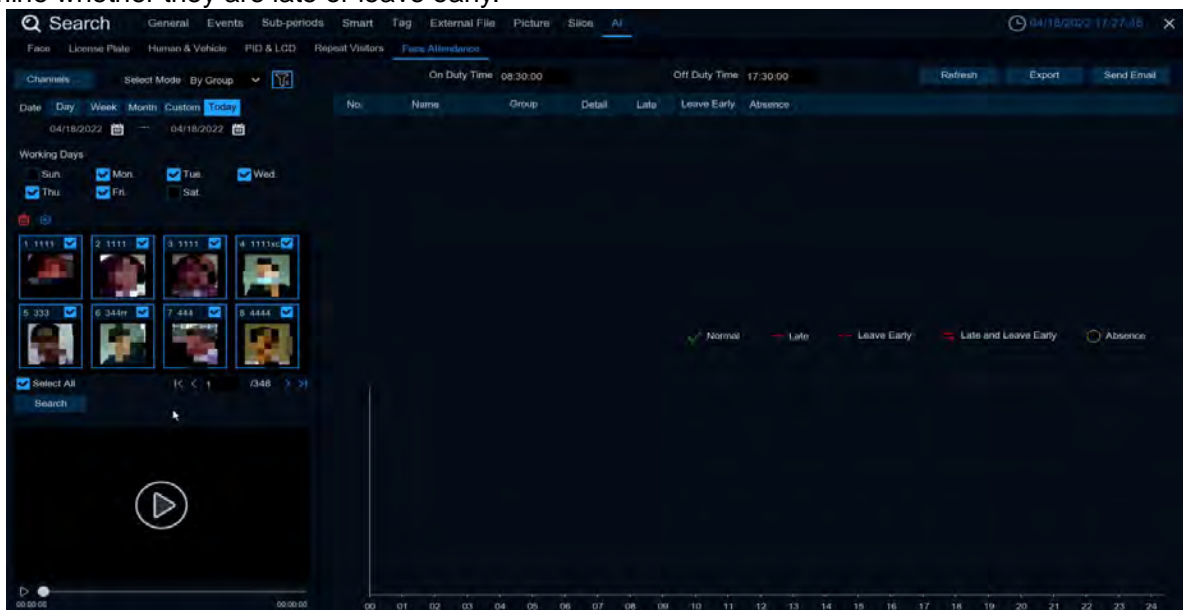

1. **Channels:** Choose the channel for face attendance
2. **Select Mode:** Select the attendance face picture, with By Group and By Person two modes  
 By Group: Select a face image through the face group, that is, add shuffling all face pictures.  
 By Person: Select the face map, click the right button of By Person to pop up the face map interface of the selection face library.
3. **Date:** Select the search date, the default is the system time day, there are five selection modes: Day, Week, Month, Custom, and Today.
4. **Working Days:** Select the working days
5. **On Duty Time:** Set up the working hours
6. **Off Duty Time:** Set up the closing time
7. Click on the Search. You can search for the results.

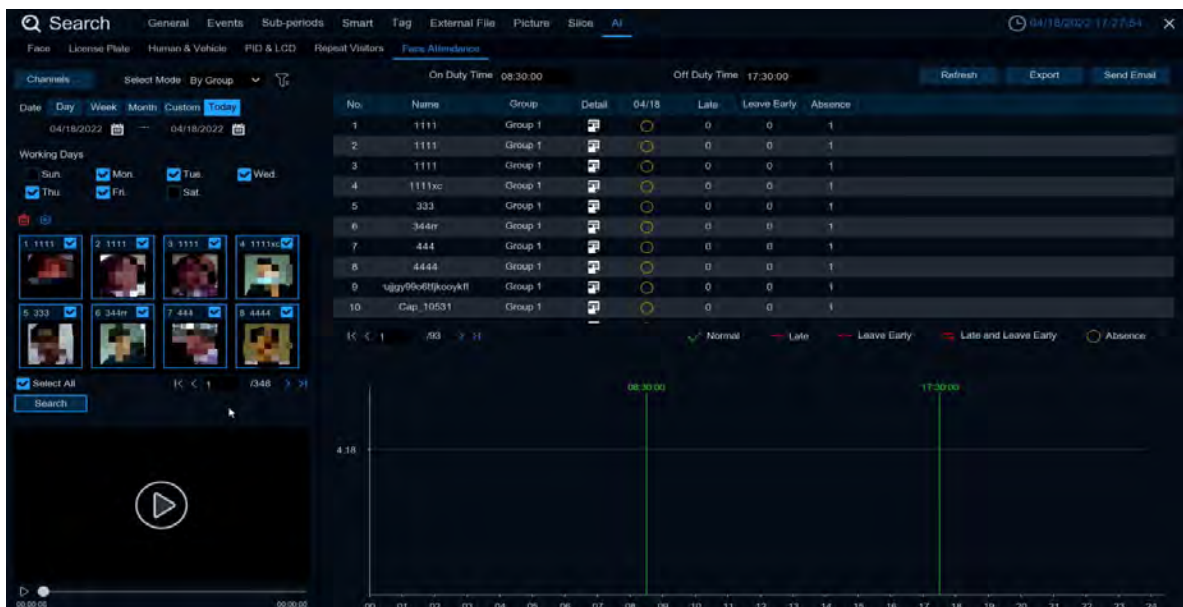

Click on a result, and all the detection records are displayed below. Click  to enter the details interface.

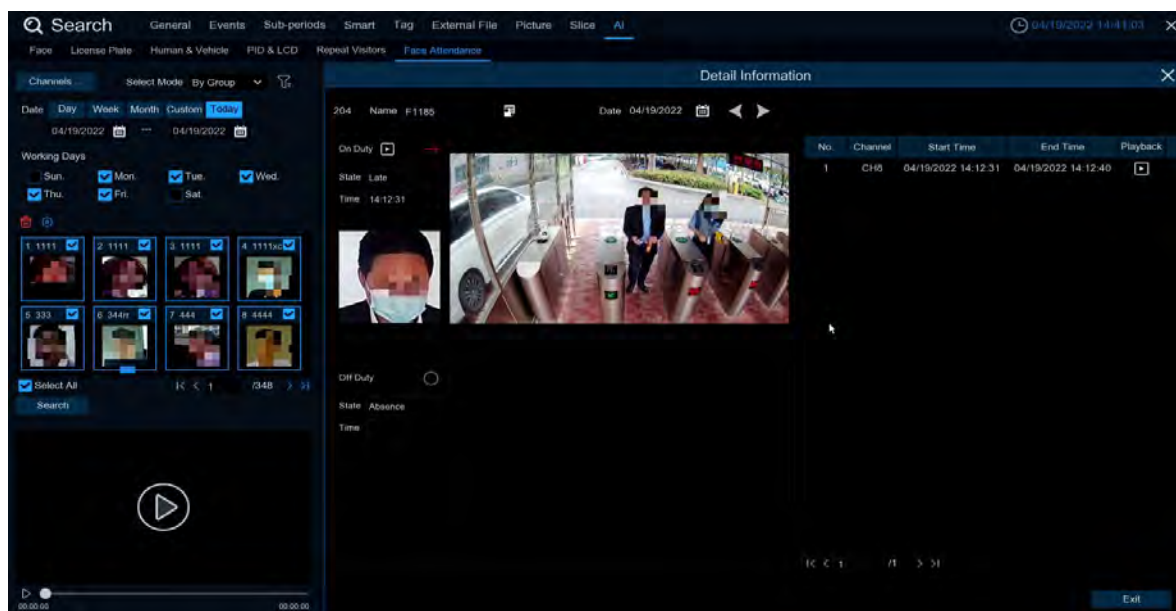

Details on attendance, including the first appearance and last appearance. Click  for a simple playback in the lower left corner.

Click **Export** to save the searched attendance information generation file to the U disk

Click **Send Email** to send the searched attendance information generation file to the mailbox

## Chapter 8 Remote Access via Web Client

Use the Web Client to remotely access your DVR at any time via a PC. Before you access the Web Client, you need to ensure that the internet settings of the DVR are configured properly

### 8.1 Basic System Environment Requirements

The minimum requirements for hardware and OS required to run Web Client are given as below.

Item	Minimum	Recommended
CPU	Intel® Core™ i5 CPU	Intel® Core™ i5 CPU or higher
RAM	4G or more	8G or more
Hard Drive	500G or more	1000G or more
Display RAM	2G or more	4G or more
Display Resolution	1280*1024	1920*1080
OS	Windows 7 or above Mac OS X® 10.9 or above	
DirectX	DirectX 11	
Direct3D	Acceleration Function	
Ethernet Adapter	10/100/1000M Ethernet Adapter	
IE	Microsoft Internet Explorer Ver. 11,10	
Mozilla Firefox	V52 version or above	
Google Chrome	V57version or above	
Mac Safari	12.1version or above	
Edge Chrome	V79 or above (Using chromium Core)	

## 8.2 Web Plugin Download and Installation

To access the Web Client, do the following:

### For IE Chrome:

1. Launch the explorer on your PC and enter the DVR IP address or DDNS domain name (Host Name) you have set on DVR in the URL box.

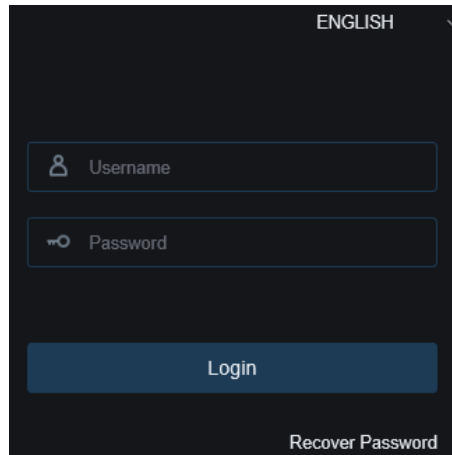

2. For the first time you run the web client, system will require to install the web client plugin. Click **download** to download the plugin and install to your computer.

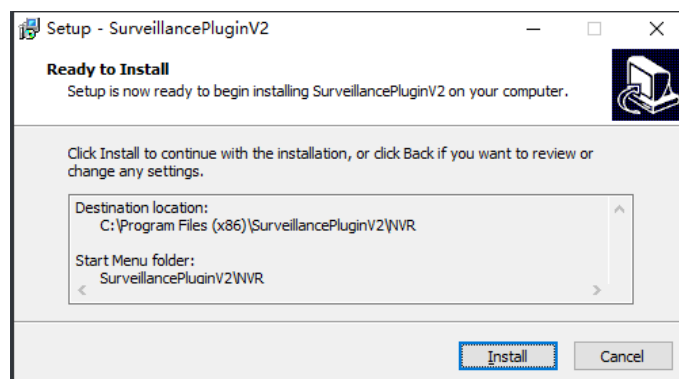
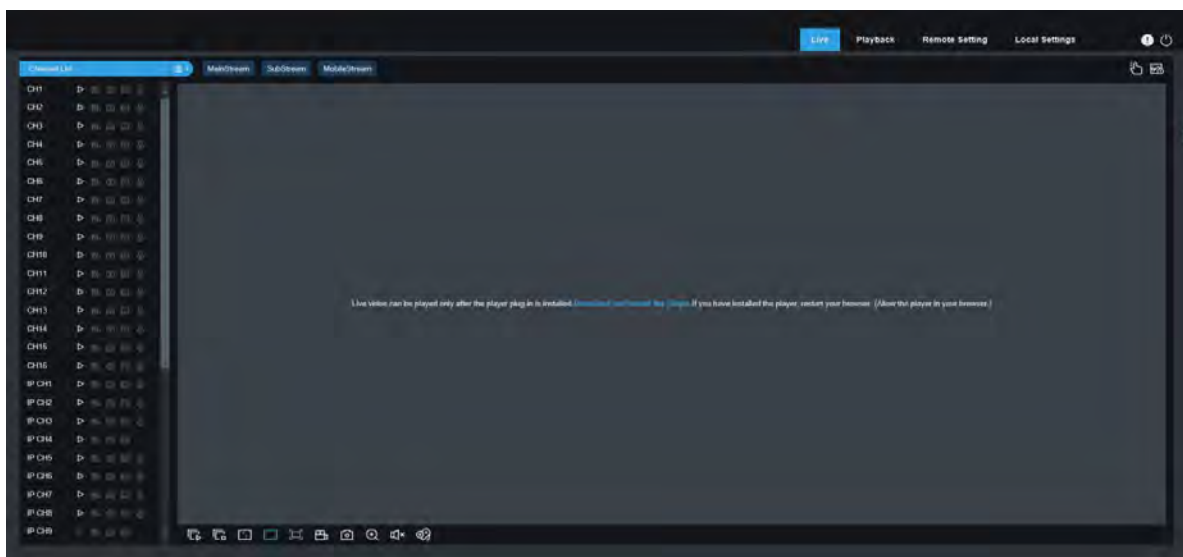

2. After installing the plug-in, refresh the page and click Allow in the pop-up window at the bottom of the page to use the image normally.

**Note:** When using Safari/ Google/Firefox /Microsoft Edge, you don't need to download the plug-in and can directly log in to the DVR.

### 8.3 Web Client Manager

The web client supports to fully control the DVR with administrator account. Please make sure to protect your user name & password for preventing illegal login.

#### 8.3.1 Live Interface

This is the first screen that opens after you have logged in to the Web Client. Here you can open or close live preview, record video to local computer manually, take snapshots of the screens, PTZ control, color adjustment, etc.



#### 1- Channel List: Open the channel list for quick camera function

Click button to display the Channel List.

Click button to hide the Channel List.

Turn the Live video stream on/off. The button is in blue color if the live video stream is on.

Manual Recording buttons. Click to start manually recording live stream video. Click again to stop recording. Manual recordings are saved to your computer. While in recording, the button is in blue color.

Manual snapshot button. Click to save a snapshot of the current live display to your computer.

Bitrate button. Set camera to use mainstream, substream or mobile stream video settings. Mobile stream is available for IP channels only.

#### 2- Live Video Stream Options:

**Mainstream:** View all live videos using high-quality mainstream video settings.

**Substream:** View all live videos using middle-quality substream video settings.

**Mobile Stream:** View all live video using lower-quality mobile stream video settings to conserve bandwidth. Available for IP channels only.

#### 3- Main Menus:

**Live:** View live video from cameras.

**Playback:** View recorded video which is saved in DVR's HDD.

**Remote Setting:** Access functions of the DVR setting menus.

**Local Settings:** Set download locations for recordings and snapshots taken using Web Client, and choose file type for video files.





- 4- **Information:** Hover over to see system details..
- 5- **EXIT**
- 6- **Manual Alarm:** Manually turn on or off Alarm Out



- 7- **Color Controls.** Click to display or hide the color controls.



- 8- **AI alarm:** To trigger the push of AI alarm event, click  to check the AI push type, which type will be pushed, click  to clear the current push list

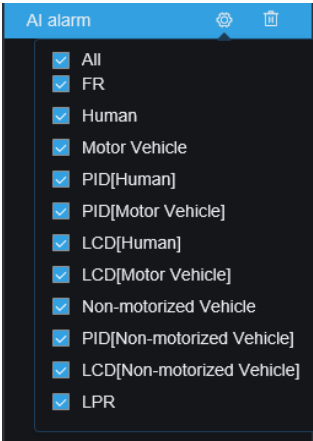

- 9- **PTZ Controls:** Click to display or hide the PTZ controls for using PTZ cameras.**PTZ Controls**

10- PTZ Controls

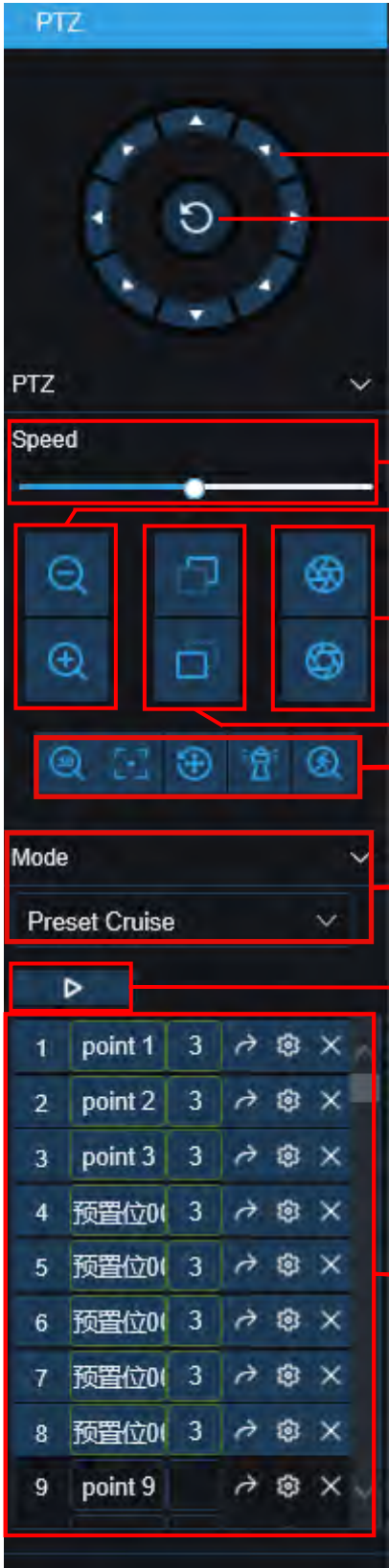

Directional Arrows: Click to move the PTZ camera

Automatic line scan.

PTZ Speed:Click to set the speed of the PTZ camera's movement.

Zoom: Click -/+ to zoom in or out.

Focus: Click -/+ to adjust focus.

Iris: Click -/+ to adjust iris.

The first icon is 3D PTZ, the second icon is autofocus, the third icon is reset preset point, the fourth icon is watch mode, and the fifth icon is manual tracking mode. For details, see5.1.4.1 PTZ control

There are six PTZ, PRESET, Line Scan, Watch Mode, Tour, and Pattern Scan modes. For details, see5.1.4.1 PTZ Control

Cruise: Start/stop PTZ cruise

Preset Point: Add, remove, or go to preset point.

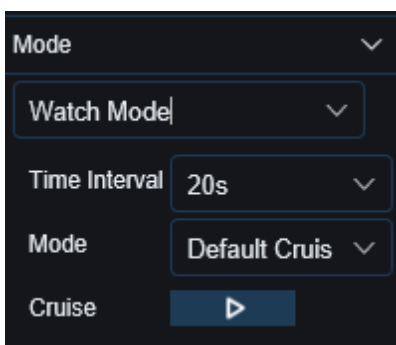

Watch Mode page:



Time Interval: wait Time of the watchposition. It is the Interval between stopping operations and resuming operations of the watch position.

Mode: Select the watch Mode, can choose the default, preset point, linear scan, track cruise, pattern scan;

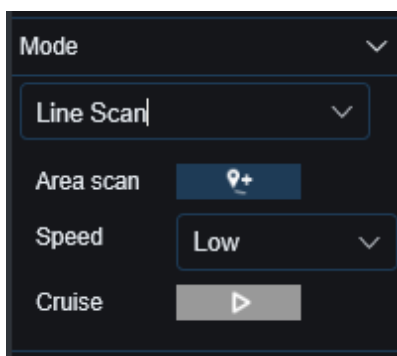
Click  to start cruising.



Line Scan Page:

Area Scan: Click  record start position, rotate the ball machine, click  record end position;



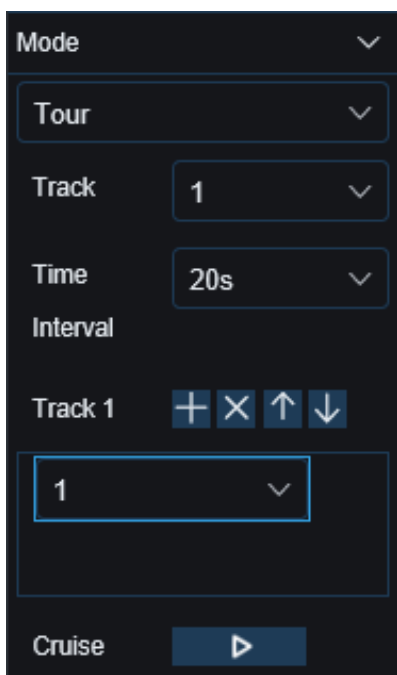

Speed: Select a linear cruising Speed.

Click  to start linear cruise. In this mode, the ball machine only moves in the same horizontal plane.





Tour Page:

Time Interval: indicates the stay Time of each preset point

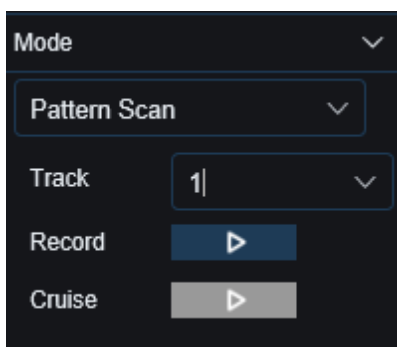
Click  Add preset point, click  Delete preset point, click/move up /move down  preset point, click  start cruise.



Pattern Scan Page:

Record: click  to start recording cruise route, click  to stop recording.

Cruise: Click  to start a Cruise using the route and action previously recorded.

**11- Live View Control Buttons:**



Channel window switch display mode

Open the all-channel preview

Close all channel preview

Original proportion: display the live video according to the original proportion

Stretch: live video to fit the entire area of each channel on the screen

Zoom in the web client to the full screen

Manual recording: Click Start manual recording for all display channels. Click again to stop the recording. Manual video recording is saved to your computer

Manual grab: Click to grab the picture of all current display channels to save to your computer

Electronic zoom: Click on an active image, and then click-drag over an area of the active image to zoom in. Right-click to return to the normal display.

Volume control: by adjusting the level size celestial volume size. Silent mode

Intercom icon: Click to open the client and DVR intercom, and click to close and DVR intercom again  
(Note: this function requires DVR support intercom function)

White light control, white light deterrent (requires connected IPC support).

Alarm control, manually open alarm warning (required for connected IPC support).

Click Add Custom Tabet. Find tags in playback ([7.1.5 TAGS](#))

**12- Navigation:** Displays the currently displayed channel page number. Use the direction keys to switch between the pages.

**13- Page View:** Click to select how many channels will appear simultaneously on the screen.

**8.3.2 Playback**

You can search & play recording videos stored in the HDD inside the DVR, and download the videos to your computer.

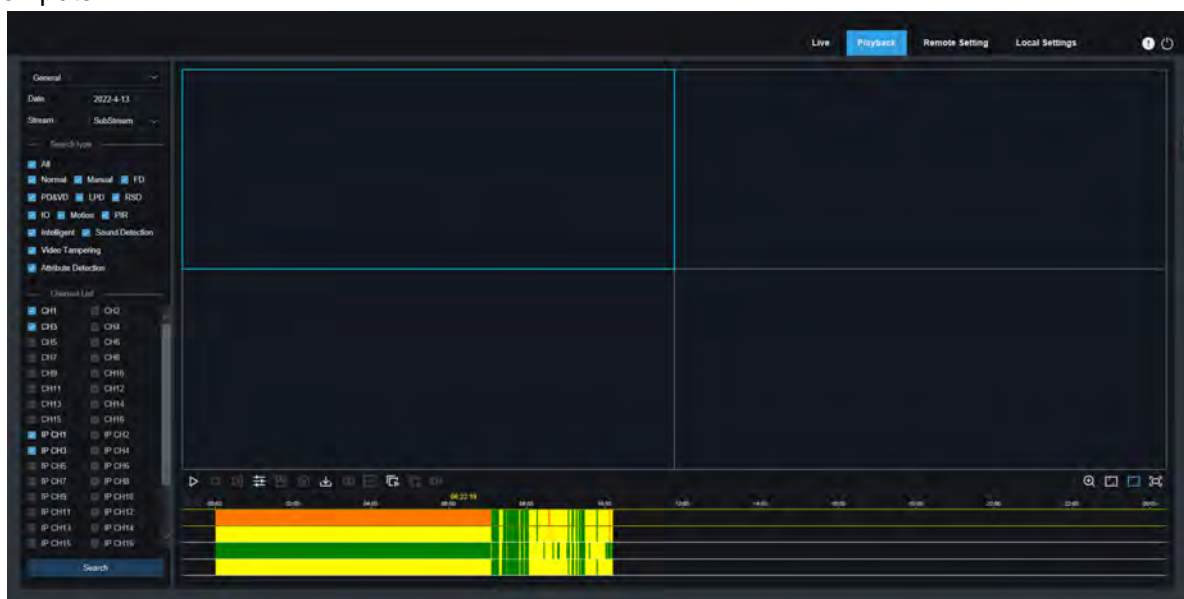



### Search Video:

- 1、 Click Playback in the top-right corner of the window.
- 2、 Select a day on the calendar to search for recordings from. Days with recordings appear with a red underline.
- 3、 Select the recording type to search for from the dropdown next to Type, or select All to search for all recordings.
- 4、 To choose the video stream you want to search & play. If you want to play Substream recordings, please make sure you had set the DVR to record with Dualstream at 5.2.2.1 Record.
- 5、 In Channels, select the channel you want to play back the video. (Up to four channels can be searched and played at the same time)
- 6、 Click **Search** to search the video
- 7、 Recordings that fit your search will be displayed in the timeline. Click a section of video where you would like to begin playback and click the ► play button.

#### 8.3.2.1 Playback Control Buttons

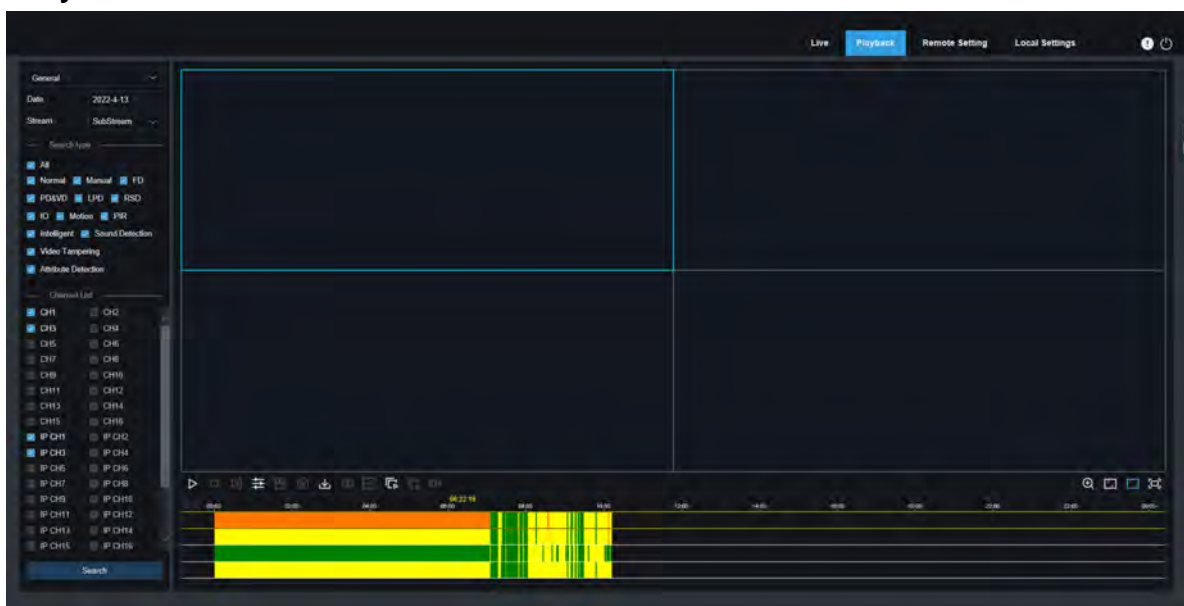

Play the single recordings



Pause



Stop playing the single recordings



**frame advance:** Move frame-by-frame through playback. Only available when the **Synchronous playback** option is not checked.



**video-synchronization:** Click to synchronize the selected channel at the same time



Click upon one of the channels which is being played and then click record button to record current video to your computer. Click again to stop recording.



Click upon one of the channels which is being played and then click capture button to take a snapshot and save to your computer.



Opens the Download menu, which allows you to download several video recordings at once.

	<input type="checkbox"/>	Start Time	End Time	Status	File Size
1	<input type="checkbox"/>	2021-02-20 00:00:00	2021-02-20 00:06:01	Not Downloaded	180.91M
2	<input type="checkbox"/>	2021-02-20 00:06:01	2021-02-20 00:14:28	Not Downloaded	253.81M
3	<input type="checkbox"/>	2021-02-20 00:14:28	2021-02-20 00:22:58	Not Downloaded	253.99M
4	<input type="checkbox"/>	2021-02-20 00:22:58	2021-02-20 00:31:24	Not Downloaded	253.73M
5	<input type="checkbox"/>	2021-02-20 00:31:24	2021-02-20 00:39:49	Not Downloaded	253.62M
6	<input type="checkbox"/>	2021-02-20 00:39:49	2021-02-20 00:48:19	Not Downloaded	253.86M
7	<input type="checkbox"/>	2021-02-20 00:48:19	2021-02-20 00:56:49	Not Downloaded	253.90M
8	<input type="checkbox"/>	2021-02-20 00:56:49	2021-02-20 01:05:18	Not Downloaded	253.83M
9	<input type="checkbox"/>	2021-02-20 01:05:18	2021-02-20 01:13:44	Not Downloaded	253.55M
10	<input type="checkbox"/>	2021-02-20 01:13:44	2021-02-20 01:22:10	Not Downloaded	253.46M
11	<input type="checkbox"/>	2021-02-20 01:22:10	2021-02-20 01:30:36	Not Downloaded	253.67M
12	<input type="checkbox"/>	2021-02-20 01:30:36	2021-02-20 01:39:06	Not Downloaded	253.98M
13	<input type="checkbox"/>	2021-02-20 01:39:06	2021-02-20 01:47:35	Not Downloaded	253.62M
14	<input type="checkbox"/>	2021-02-20 01:47:35	2021-02-20 01:56:01	Not Downloaded	253.58M

14 Row / Page      << < 1 / 14Page > >>

Start Download   Stop Download

Choose the files you want to download, press **Start Download** button to begin, you will see the download status. Press **Stop Download** button to stop.

 **Playback Speed.** Click to choose the playing speed.

 **Play All Channels:** Click to play all channels you have chosen to searched. Only available when the **Synchronous playback** option is not checked.

 **Stop All Channels:** Click to stop playing all channels. Only available when the **Synchronous playback** option is not checked.

 **Digital Zoom:** Click upon on a playing video, then click-and-drag over an area of the video to enlarge. Right-click to return to the normal display.

 **Original Proportions:** Shows the playing video at the original proportions

 **Stretch:** Stretch the playing video to fit the full area for each channel on screen.

 To enlarge the web client to full screen.

### 8.3.2.2 Picture playback

After setting the captured image in [5.2.3.1 Capture](#), you can search the captured image here. A maximum of 5000 images can be searched at one time. You can modify the time interval for searching as required.

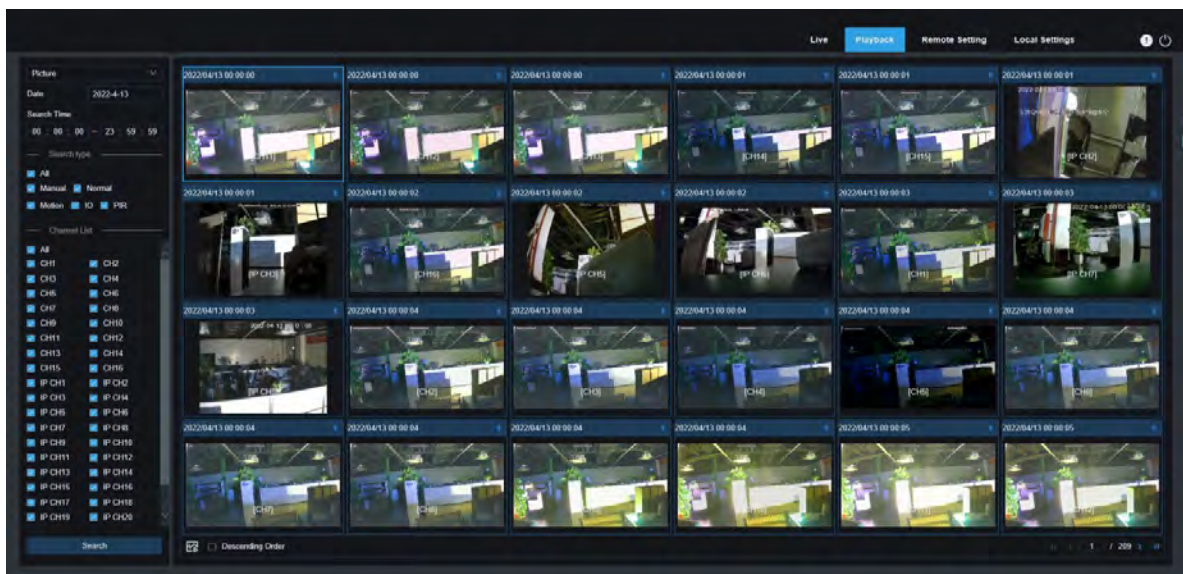

Search snapshot:

1. Click playback in the upper right corner of the window.

2. Select picture from the drop-down menu in the upper left corner.
3. Select a day to search on the calendar. The date with the snapshot is underlined in red.
4. Select the image type to search from the list in the search type menu, or select all to search all types.
5. Check the channel to search for videos.
6. Click Search
7. Images that match your search criteria will be displayed on the right

You can double-click any picture to enter the small fragment playback interface, and click  to return to the previous interface

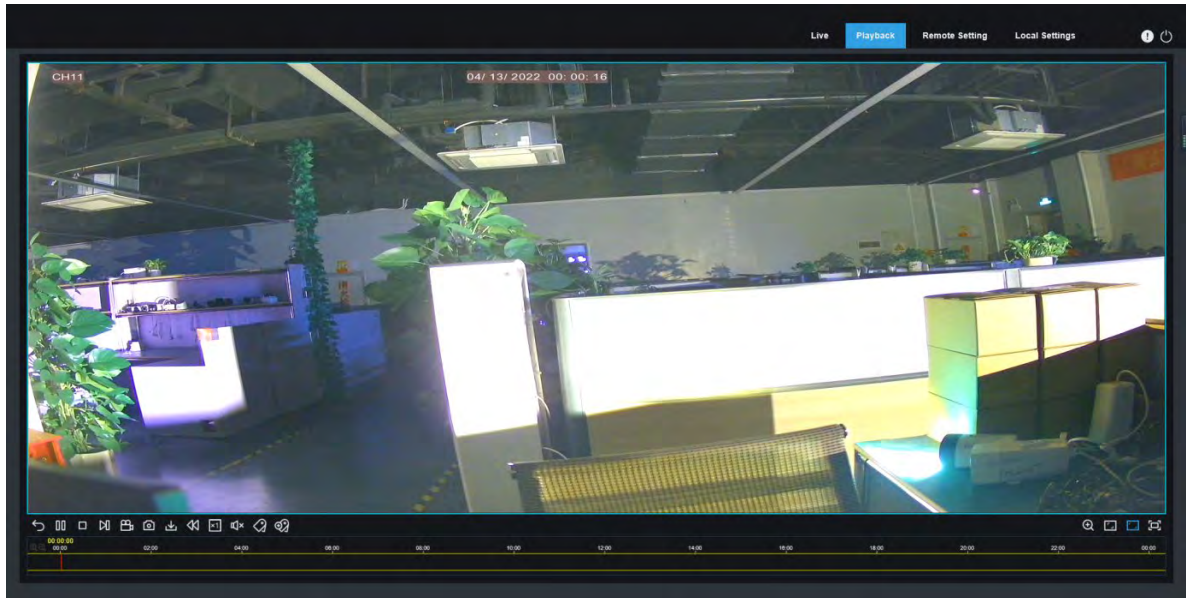

### 8.3.2.3 Tag playback

In this menu, you can view all the tags that have been added

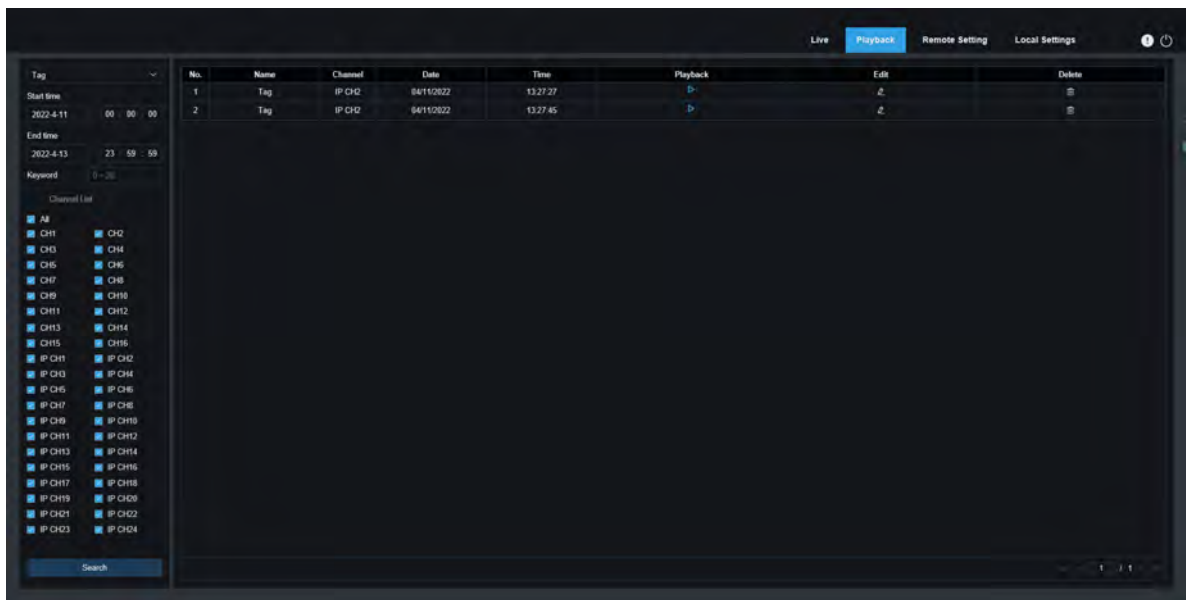

Details see [7.1.5 Tag](#).

### 8.3.2.4 Smart Playback

After setting the mobile detection in [5.1.6 Motion Detection](#), the mobile detection alarm is triggered with the human form to search the Smart playback video in the plug-free browser (Apple Safari / Google browser / Firefox browser / Microsoft Edge browser).



Click  the display smart settings area, click  to select all areas, click  to clear all selected areas.

### 8.3.2.5 AI Playback

After the AI alarm is set in [5.4 AI](#), you can search for AI alarm events here, including face detection, license plate detection, pedestrian and vehicle detection, PID & LCD, repeat guest and face attendance

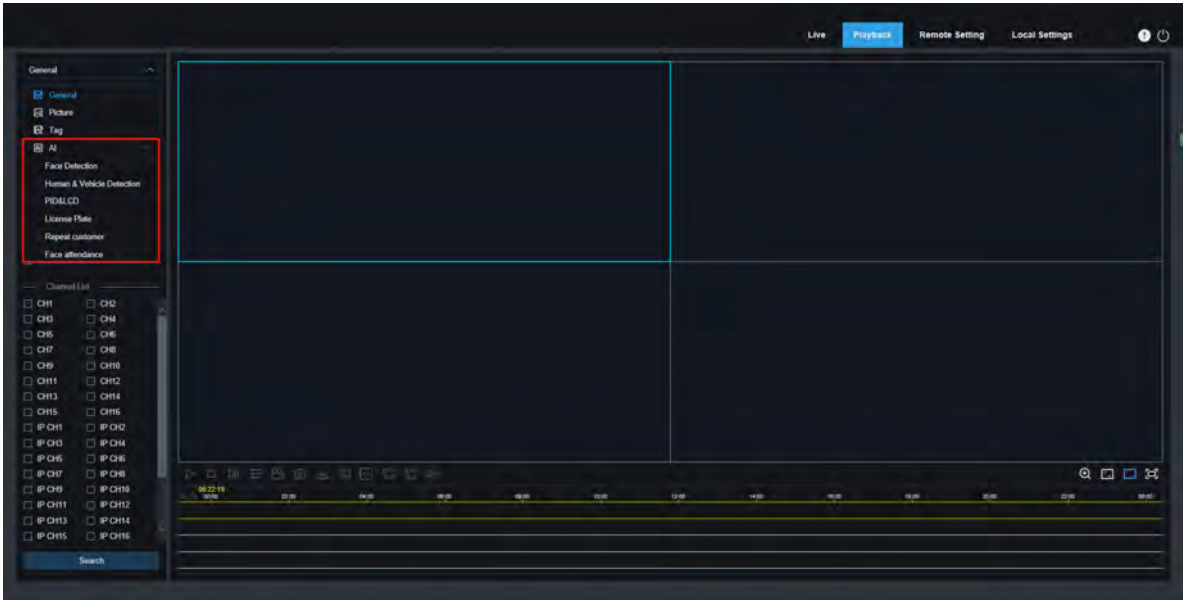



### 8.3.3 Remote Setting

Here you can remotely configure the settings of the DVR. Please see “[Chapter 5 DVR System Setup](#)” for more details on the DVR settings

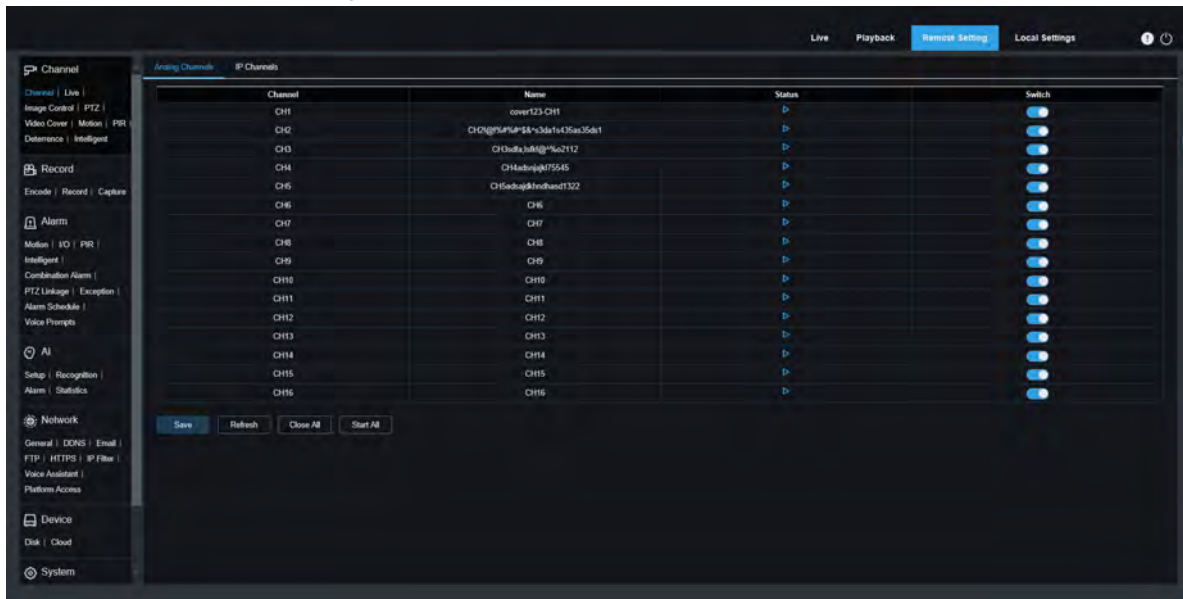

### 8.3.4 Local Setting

Set download locations for recordings and snapshots taken using Web Client, and choose file type for video files.

The 'Path configuration' dialog box shows the following settings:

- Record Path: D:\Device\Record
- Download Path: D:\Device\Download
- Snapshot Path: D:\Device\Capture
- File type: MP4
- Capture Type: JPG

A 'Save' button is located at the bottom of the dialog.

**Record Path:** Click to browse for and select the folder where you would like the manual video recordings to be saved on your computer.

**Download Path:** Click to browse for and select the folder where you would like to save the download video recordings to your computer.

**Snapshot Path:** Click to browse for and select the folder where you would like the manual capture snapshots to be saved on your computer.

**File Type:** Choose your preferred file type for manual recordings.

**Capture Type:** Choose your preferred file type for manual capture.

**Save:** Click to save the modifications.

## Chapter 9 Viewing Backed Up Video on PC/Mac

This section will help you to play the backup files with the powerful video player which is attached in the CD.

For Mac users, please install the app “VideoPlayer\_x.x.xx\_xxxx\_xx\_x.dmg”, for example: VideoPlayer\_1.0.15\_2017\_01\_6.dmg.

For PC users, please install the software “VideoPlayer\_x.x.xx\_xxxx\_xx\_xx.exe”, for example: VideoPlayer\_1.0.15\_2017\_01\_06.exe.

### Minimum System Requirements

- Intel Pentium 4 or above
- Microsoft Windows XP / Vista / 7 / 8 / 10
- 256MB RAM
- 16MB video memory

1. Install the Video Player software in the CD and run.

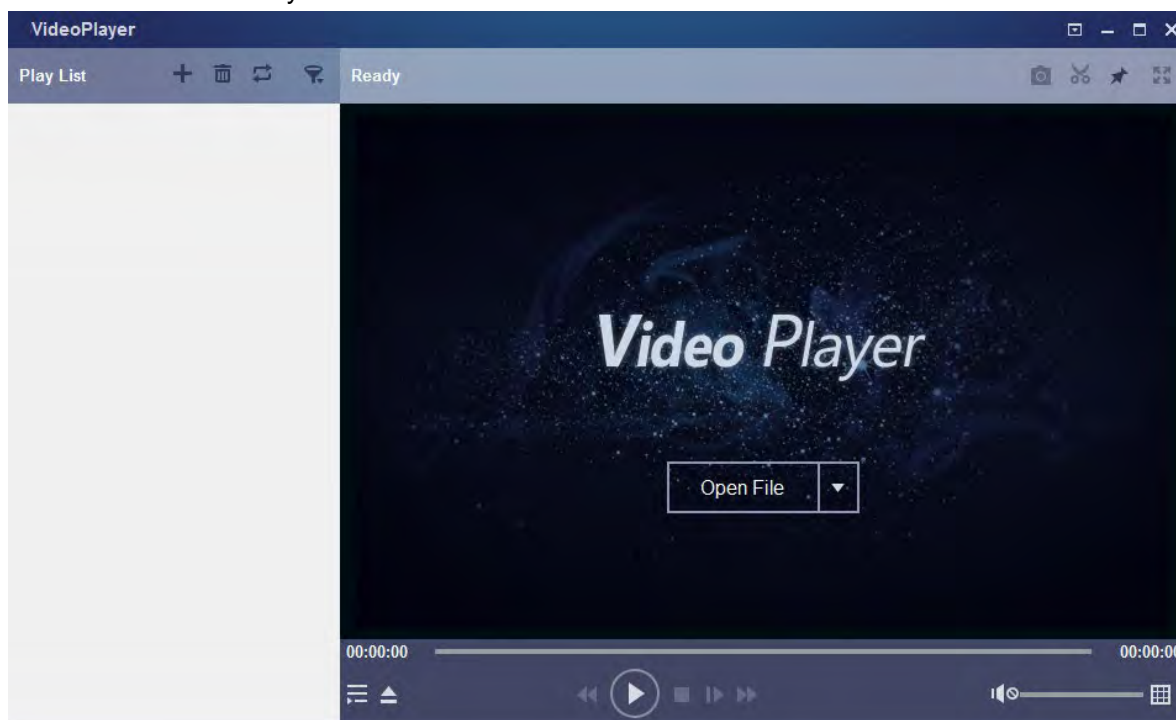

2. Copy the backup files to your computer.
3. Click **Open File** button or click **+** button on the Play List to load single or multiple video files. It supports to add & play “.rf”, “.avi”, “.mp4”, “.264” and “.265” files. Click  button to load a folder with backed-up videos.

## Video Player Control

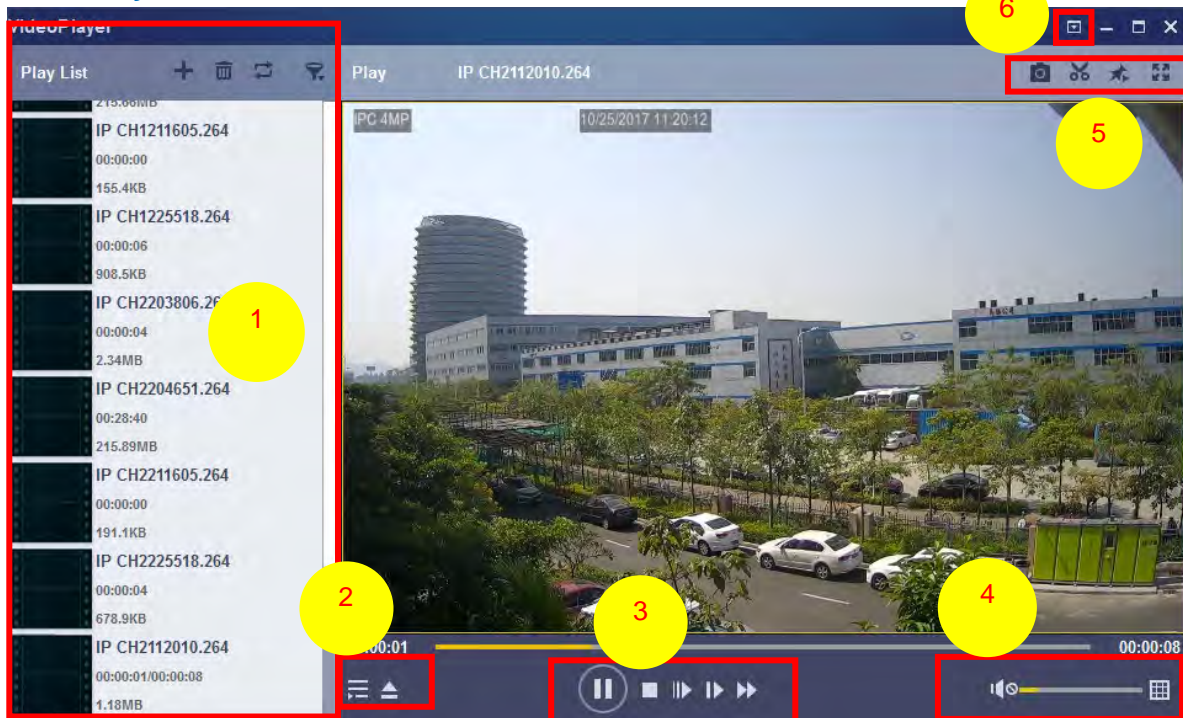

## 1. Play List

Add files

Remove files

To choose play mode: play a single file and stop; play all listed files by sequence; repeat one file; repeat all files.

Filter by file name

## 2. Hide/Show Playlist

Click to open files or load a folder.

## 3. Play Controls

Play

Pause

Stop

Play frame by frame. Click once to play a frame of the video

Slow Play, 1/2, 1/4 and 1/8, 1/16 speed

Fast Forward, x2, x4, x8 and x16

## 4. Volume control

Multi-screen play. It allows to play multiple videos at a time. When you choose multi-screen, you can drag the video in Play List to the play screen.

## 5. Take snapshot

To save a video clip to your computer. Press once to start, press again to end the video clip.

Keep the video player on top

Enlarge the video play screen to full screen

6.  **Advanced Setup Menu** allows to choose the OSD language of the video player, and configure the setting of video player.

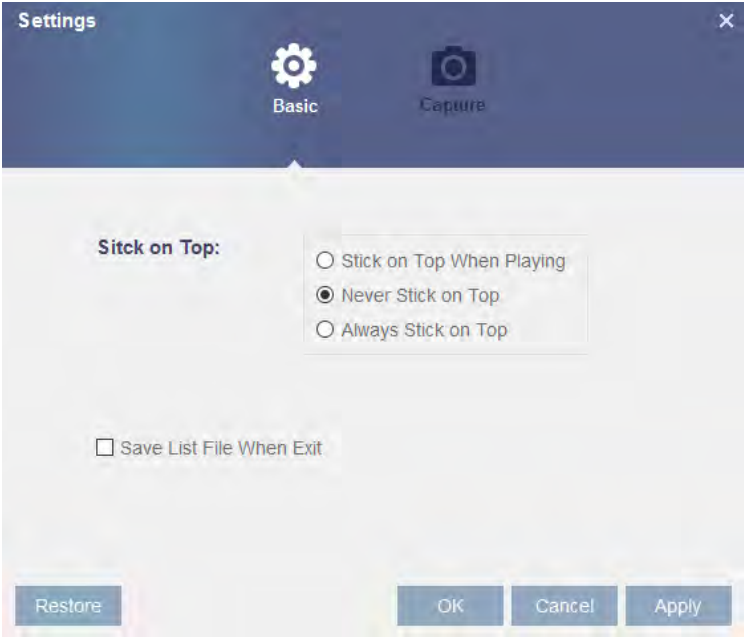

**Basic Settings:** Set on-top mode

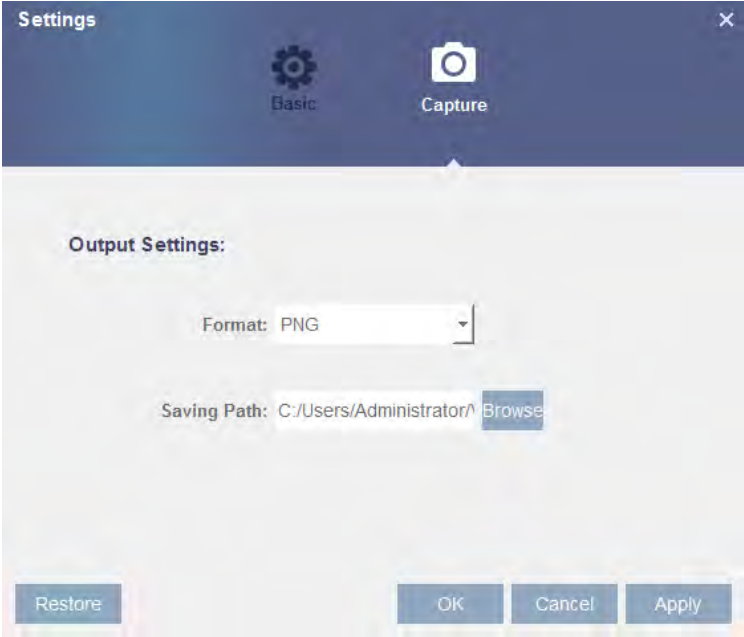

**Capture Settings:** Set the format and the path to save snapshots.



## Chapter 10 Remote Access via Mobile Devices

The DVR supports to remote access via mobile devices based on Android & iOS operating system.

- 1) Search eneolNSight mobile from Google Play Store for android devices or App Store or iOS devices and install.
- 2) Run the app, it will display the live view screen.

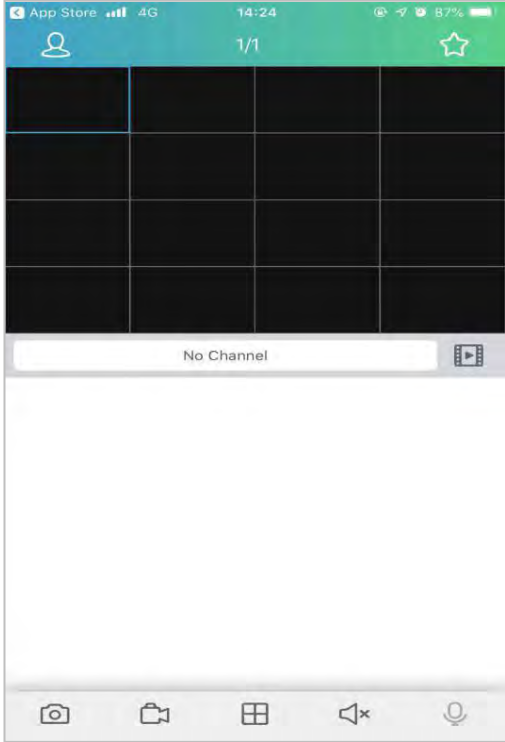

- 3) Touch the icon  to open the main menu.

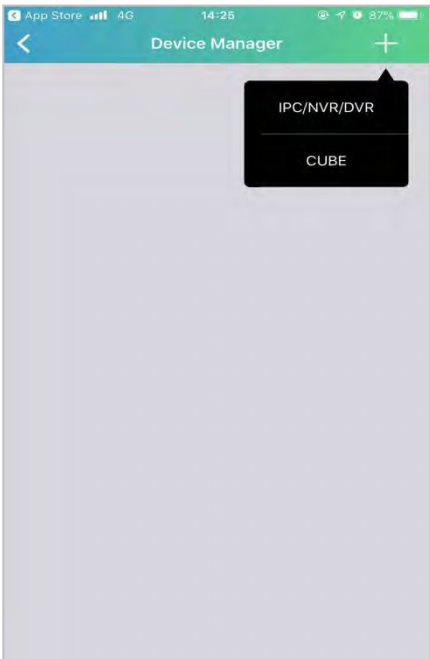
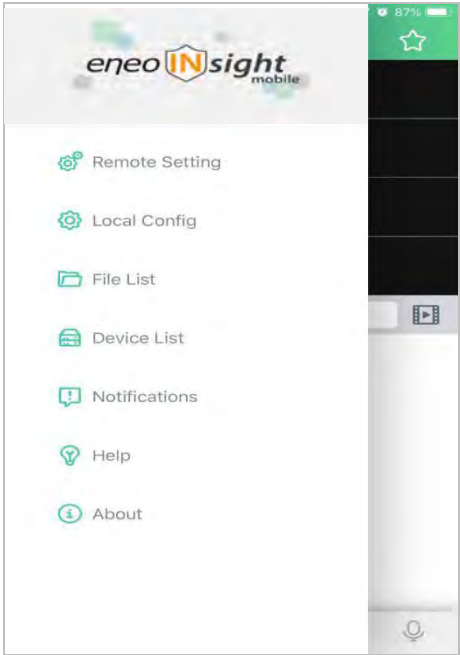

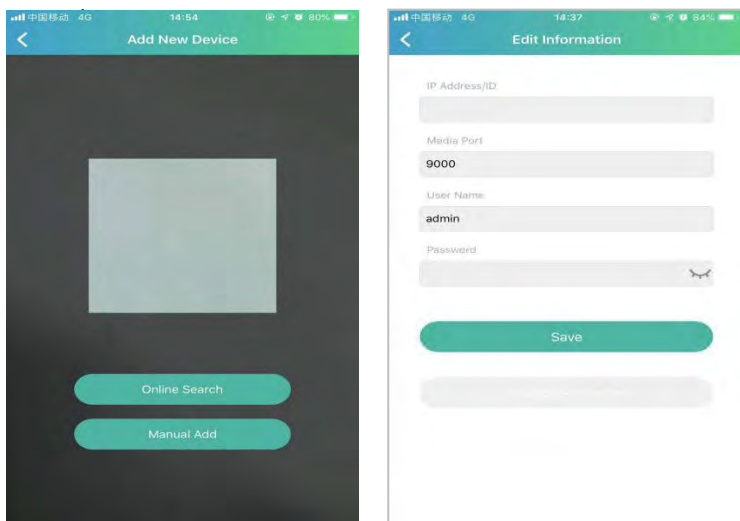

4) Select **Manual Add** and enter the DVR information to Add a new device.



1. **Scan the QR code:** Scan the QR code to add devices.
2. **Online search:** On the same LAN as the device, search and add.
3. **Manually add:**  
IP address /ID: Enter the IP address or P2P ID.
4. **Media port:** Enter the media port in the DVR network Settings.  
**User name/Password:** Enter the user name and password of the DVR.

1) After all settings are complete, click Save. When the device is well connected, the app goes to real-time display.



-  1 Channel display
-  4 Channel display
-  6 Channel display
-  8 Channel display
-  9 Channel display
-  16 Channel display

**NOTE:** The application displays up to 16 channels in one screen interface, and you can swipe the screen and move to the next screen to view the other 16 channels, for a total of 80 channels.



**Capture:** capture the image of the selected channel picture and save it in the APP file



**Video:** record the selected channel screen, save in the APP file list, download the recorded video to the mobile phone in the file list



**Audio:** Turn the sound on or off



**intercom:** Two-way device intercom (if your DVR supports)



**PTZ Control** (if your IPC supports it)



**Close the channel:** hold down the video image, this icon appears above the window, drag and pull the video to this icon and close the video preview.

## Chapter 11 Appendix

### .11.1 FAQ questions

1. What should I do if the hard disk is not detected?

A: If the system does not detect the hard disk, check whether the data cable and power cord are well connected, faulty with the interface on the motherboard, or whether the hard disk is supported in the specification.

2. After changing the system password, you accidentally forget and can not enter the system?

A: When the administrator forgets the password, please contact our technician. It is recommended that users should set an easy to remember and relatively secure password (if you have security requirements, please try not to set a simple password such as 000000).

3. Why do the DVR and the camera have the normal power supply but no video signal or abnormal images and output at the monitor end?

A: Please check whether the network cable of DVR is well connected, whether the network cable is used too aging, or check whether the N system / P system selection is consistent.

4. What effects may heat dissipation have in D V R work?

Answer: The operation of DVR will produce a certain amount of heat. Please place the DVR in a safe and well ventilated place to avoid the DVR from affecting the stability and service life of the system for a long time.

5. Why can the remote control of DVR not operate, while the monitoring screen is normal and the panel buttons can be used?

Answer: If the IR signal is aligned at the front panel of the body but the remote control is still invalid, please check whether the battery in the remote control is normal and sufficient. If it is not the above problem, the remote control is broken.

6. If I put the hard drive on my PC into the DVR, can I use it?

A: If it is a hard disk that your system can support, it is important to note that the data on your hard disk will be lost once the DVR is running.

7. Can you play it back along with the video?

A: Yes, the native system can support recording while playback video recording.

8. Can you clear some video records on the DVR hard disk?

A: Considering the security of the file, you can't clear a part of the video operation, you really need to delete all the video records can choose to format the hard disk operation.

9. Why can't you enter the DVR client?

Answer: Please check whether the network connection mode configuration is correct, whether the RJ-45 interface contact is good, and then when the network login password switch is opened, please check whether your account and password correspondence are correct.

6. What can not find any recorded information when playing the video back?

A: Please check whether the data cable of the hard disk is well connected and whether the system time is being illegally adjusted. Try several times, if the above phenomenon still appears to check whether the hard disk is damaged.

7. Why can't DVR control the cloud head?

A: Please check it up:

A) Front PTZ fault.

The b) cloud head decoder is not set up, connected and installed correctly.

c) Incorrect DVR PTZ settings.

d) The cradle head decoder protocol does not match the DVR protocol.

e) The cradle head decoder address does not match the DVR address.

f) If multiple decoders are connected, the PTZ decoder AB line should add 120 resistance to achieve reflection inhibition and impedance matching. Otherwise, the cloud head control will be unstable.

1. Why doesn't dynamic detection work?

Answer: Check whether the mobile detection time and the mobile detection area setting are correct, and also check whether the sensitivity setting is too low.

13. Why doesn't the alarm work?

Answer: Check whether the alarm setting and alarm connection are correct, and whether the alarm input signal is correct.

14. Why do the buzzers keep ringing?

Answer: Check the relevant setting of the alarm, whether the mobile detection is on and detected, whether the I / O alarm is normally closed, and check the relevant hard disk alarm setting.

15. Why is the system still being recorded by sometimes pressing the "STOP" key or clicking on the "Stop recording" in the shortcut menu?

Answer: press "STOP" or click "stop video"; stop manual video can modify the video status of some time to no video, to stop the video mode to timing or manual video, and then stop the video in the above way.Or to stop recording you can set the channel status in the recording setting to close.

## **11.2 Usage Maintenance**

1. To shut down DVR, please firstly shut down the system and then turn off the power. Do not turn off the power directly or HDD data will be lost or damaged.

2. Please keep DVR away from heat sources or places.

3. Clean the internal dust regularly. Make sure the good ventilation of DVR so as to ensure the good heat dissipation.

4. Please do not hot plugging audio and video cables, or cables connected to ports like RS-232 or RS-485. Otherwise the ports will be damaged.

5. Please check the HDD cable and data cable regularly to see if they are ageing.

6. Please prevent the audio and video signals of DVR from being intervened by other electronic devices, and prevent the HDD from being damaged by static electricity and induced voltage. If the network cable is frequently plugged, it is suggested to replace connecting line regularly, or the input signal may be unstable.

7. This is a class of product. It maybe bring wireless interference in life. Under this situation, it need user to make measures.



### 11.3 Accessories (For reference only)



Remote Controller



Power Adapter



Warranty Card



USB mouse



CD

#### CAUTION

RISK OF EXPLOSION IF BATTERY IS REPLACED BY AN INCORRECT TYPE  
DISPOSE OF USED BATTERIES ACCORDING TO THE INSTRUCTIONS

The material in this document is the intellectual property of our department

No part of this manual may be reproduced, reproduced, translated, transmitted or published in any form or by any means, without the prior written permission of the department.

Our products are under constant development and we reserve the right to make changes without notice. However, we cannot guarantee the correctness of its content, and we do not assume any responsibility for damages caused by using of our products.

The model numbers of the products are recognized in the user manual only, but these names may also be registered trademarks or copyrights of other companies.

Product images may differ from the actual product and are for reference only. Accessories may vary according to different sales regions.

For details on accessories, please consult your local dealer.



eneo® is a registered trademark of  
VIDEOR E. Hartig GmbH  
Exclusive distribution through special-  
ised trade channels only.

VIDEOR E. Hartig GmbH  
Carl-Zeiss-Straße 8  
63322 Rödermark/Germany  
Tel. +49 (0) 6074 / 888-0  
Fax +49 (0) 6074 / 888-100  
[www.videor.com](http://www.videor.com)  
[www.eneo-security.com](http://www.eneo-security.com)

Technical changes reserved

© Copyright by VIDEOR E. Hartig  
GmbH Version 06/2022