



EN

# User Manual

**1/2,8" HD Analogue Dome, PTZ,  
Day&Night, 20x, 4,7-94mm,  
1920x1080, WDR, IP66**

**MPP-62A0020M0B**

# WARNING

TO REDUCE THE RISK OF FIRE OR ELECTRIC SHOCK, DO NOT EXPOSE THIS PRODUCT TO RAIN OR MOISTURE. DO NOT INSERT ANY METALLIC OBJECTS THROUGH THE VENTILATION GRILLS OR OTHER OPENINGS ON THE EQUIPMENT.

# CAUTION

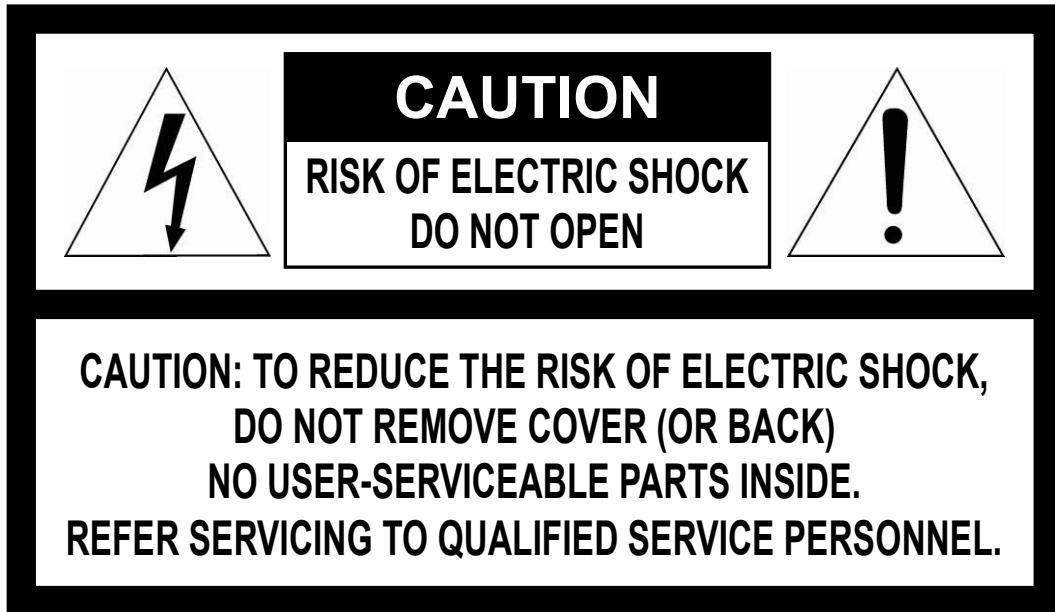

# EXPLANATION OF GRAPHICAL SYMBOLS

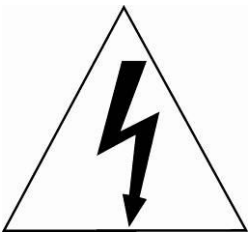

The lightning flash with arrowhead symbol, within an equilateral triangle, is intended to alert the user to the presence of uninsulated “dangerous voltage” within the product’s enclosure that may be of sufficient magnitude to constitute a risk of electric shock to persons.



The exclamation point within an equilateral triangle is intended to alert the user to the presence of important operating and maintenance (servicing) instructions in the literature accompanying the appliance.

# FCC COMPLIANCE STATEMENT

This device complies with Part 15 of the FCC Rules. Operation is subject to the following two conditions: (1) this device may not cause harmful interference, and (2) this device must accept any interference received, including interference that may cause undesired operation.

**FCC INFORMATION:** This equipment has been tested and found to comply with the limits for a Class A digital device, pursuant to Part 15 of the FCC Rules. These limits are designed to provide reasonable protection against harmful interference when the equipment is operated in a commercial environment. This equipment generates, uses, and can radiate radio frequency energy and, if not installed and used in accordance with the instruction manual, may cause harmful interference to radio communications. Operation of this equipment in a residential area is likely to cause harmful interference in which case the user will be required to correct the interference at his own expense.

**CAUTION:** Changes or modifications not expressly approved by the party responsible for compliance could void the user's authority to operate the equipment.

This Class A digital apparatus complies with Canadian ICES-003.

Cet appareil numérique de la classe A est conforme à la norme NMB-003 du Canada.

# CE COMPLIANCE STATEMENT

## **WARNING**

This is a Class A product. In a domestic environment this product may cause radio interference in which case the user may be required to take adequate measures.

# IMPORTANT SAFETY INSTRUCTIONS

---

1. Read these instructions.
2. Keep these instructions.
3. Heed all warnings.
4. Follow all instructions.
5. Do not use this apparatus near water.
6. Clean only with dry cloth.
7. Do not block any ventilation openings. Install in accordance with the manufacturer's instructions.
8. Do not install near any heat sources such as radiators, heat registers, stoves, or other apparatus (including amplifiers) that produce heat.
9. Do not defeat the safety purpose of the polarized or grounding-type plug. A polarized plug has two blades with one wider than the other. A grounding type plug has two blades and a third grounding prong. The wide blade or the third prong is provided for your safety. If the provided plug does not fit into your outlet, consult an electrician for replacement of the obsolete outlet.
10. Protect the power cord from being walked on or pinched particularly at plugs, convenience receptacles, and the point where they exit from the apparatus.
11. Only use attachments/accessories specified by the manufacturer.
12. Use only with the cart, stand, tripod, bracket, or table specified by the manufacturer, or sold with the apparatus. When a cart is used, use caution when moving the cart/apparatus combination to avoid injury from tip-over.
13. Unplug this apparatus during lightning storms or when unused for long periods of time.
14. Refer all servicing to qualified service personnel. Servicing is required when the apparatus has been damaged in any way, such as power-supply cord or plug is damaged, liquid has been spilled or objects have fallen into the apparatus, the apparatus has been exposed to rain or moisture, does not operate normally, or has been dropped.
15. **CAUTION – THESE SERVICING INSTRUCTIONS ARE FOR USE BY QUALIFIED SERVICE PERSONNEL ONLY. TO REDUCE THE RISK OF ELECTRIC SHOCK DO NOT PERFORM ANY SERVICING OTHER THAN THAT CONTAINED IN THE OPERATING INSTRUCTIONS UNLESS YOU ARE QUALIFIED TO DO SO.**
16. **Use satisfy clause 2.5 of IEC60950-1/UL60950-1 or Certified/Listed Class 2 power source only.**



# Table of Contents

<b>Chapter 1 — Introduction</b> .....	<b>6</b>
1.1 Features .....	6
<b>Chapter 2 — Installation and Configuration</b> .....	<b>7</b>
2.1 Package Contents.....	7
2.2 Mounting the Camera .....	8
2.2.1 Locking the Camera .....	8
2.2.2 Heater Kit Installation (Optional) .....	10
2.3 Basic Configuration of Dome Camera System .....	11
2.4 Setting Dome Camera (DIP Switch) .....	12
2.5 Setting Dome Camera Address (ID).....	13
2.6 Connections.....	13
2.7 Getting Started.....	14
<b>Chapter 3 — Program and Operation</b> .....	<b>15</b>
3.1 Dome Camera Selection.....	15
3.2 Accessing the On-Screen Menu Utility.....	15
3.3 How to control the On-Screen Menu Utility .....	15
3.4 Auto Scan.....	16
3.5 Preset .....	18
3.6 Tour.....	20
3.7 Pattern .....	22
3.8 Privacy Zone .....	23
3.9 Camera Menu .....	24
3.10 Dome Communication.....	27
3.11 Alarm.....	28
3.12 Dome Setup.....	29
<b>Appendix A — Specifications</b> .....	<b>36</b>
<b>Appendix B — Troubleshooting</b> .....	<b>38</b>

# Chapter 1 — Introduction

## 1.1 Features

- Built-in optical power zoom camera with True Night Shot function
- 240 Preset positions with the individual camera AE setup
- 8 Tours consist of Presets, Patterns, Auto Scans and other Tours can be programmed with over 300 functions and preset locations. While moving, each Preset scan can be watched in smooth **Vector Scan** mode.
- 16 Auto Scans with the normal, the vector, and the **random** mode and the endless Auto-Pan with 13 speed steps
- 8 Patterns (up to 500 seconds) and 16 Privacy Zones
- 4 Alarm inputs, 2 Alarm outputs (5VTTL)
- Variable speed from 0.1°/sec. to 380°/sec.  
Three Variable speed (SLOW, NORMAL, TURBO)
- Pan/Tilt speed is inversely proportional to the zoom ratio with the option.
- Maximum speed is 380°/sec. when Preset command.
- Auto Calibration from 0.1° to 6° (Tilt range is -10° to 190°)
- Programmable user preferences (alarm, preset, title, etc.)
- 180° Digital Flip
- Function Run menu using DVR without function key (Pattern, Scan ...)
- Built-in RS-485 receiver driver (Up to 3999 selectable camera addresses)
- 12VDC or 24VAC for Camera

# Chapter 2 — Installation and Configuration

## 2.1 Package Contents

This system comes with the following components;

* Dome Camera .....	1
* Instruction Manual (This Document) .....	1 (Optional)
* Template Sheet .....	1
* Mounting Bracket .....	1
* Safety Lanyard .....	1
* Accessory Kit .....	1
1) Mounting screws (PH6 x 35.0) .....	(4)
2) Plastic anchors .....	(4)
3) O-Rings .....	(4)
4) Torx wrench .....	(1)
* Accessory Connector .....	1
1) 2-Pin Terminal Block .....	(1)
2) 3-Pin Terminal Block .....	(1)
3) 4-Pin Terminal Block .....	(1)
4) 5-Pin Terminal Block .....	(1)

**NOTE: Check your package to make sure that you received the complete system, including all components listed above.**

**NOTE: Adaptor for 12VDC & 24VAC is not supplied.**

## 2.2 Mounting the Camera

The dome camera is for use in surface or pendent mounting applications, and the mounting member must be capable of supporting loads of up to 10 lb (4.5 kg). (Pendent mounting must use pendent mount accessory.)

The dome camera's mounting bracket should be attached to a structural object, such as hard wood, wall stud or ceiling rafter that supports the weight of the dome camera.

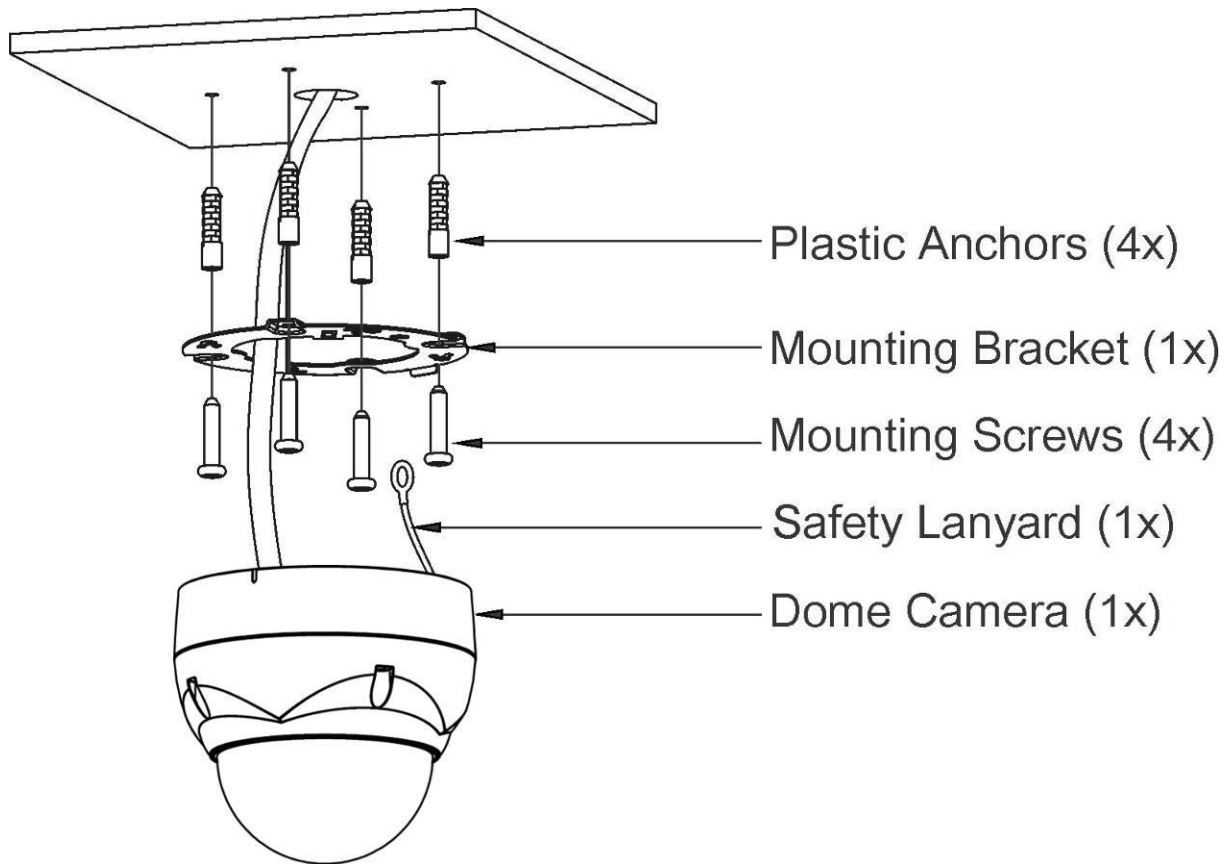

**CAUTION: A silicone rubber sealant must be applied to seal the housing to secure waterproofing.**

**CAUTION: Please reset the camera after 30 ~ 60 minutes when installing it in situations colder than -10°C.**

### 2.2.1 Locking the Camera

1. Make screw holes on the ceiling using the supplied mounting Template Sheet (Figure A).
2. Fix the Mounting Bracket to the ceiling using supplied Anchors (4x) and Mounting Screws (4x) (Figure B).
3. Hook up the Safety Lanyard to the Safety Lanyard Hook of the Mounting Bracket (Figure C).
4. Align the locking tab on the bracket and the locking slot on the base of the dome (Figure D).
5. Turn the dome to the counterclockwise about 10 degree to the locked position (Figure E).



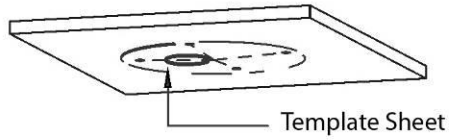

Figure A

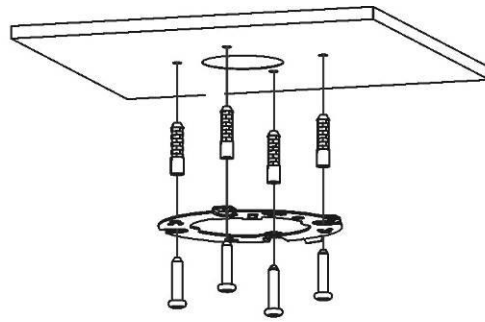

Figure B

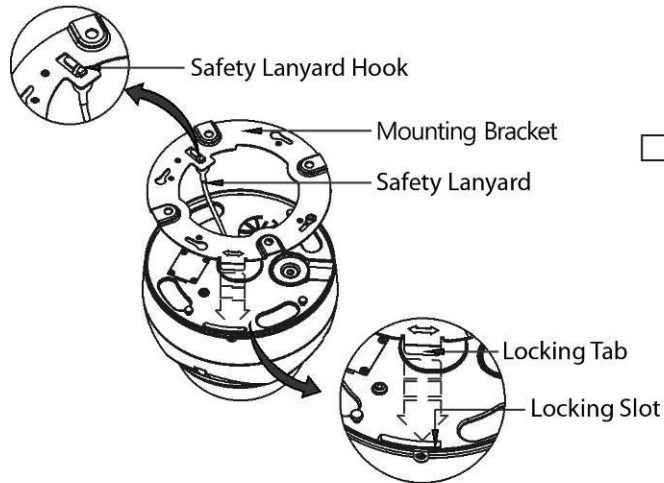

Figure C

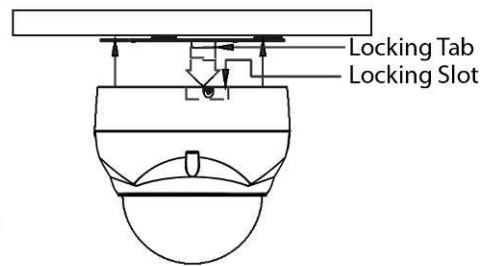

Figure D

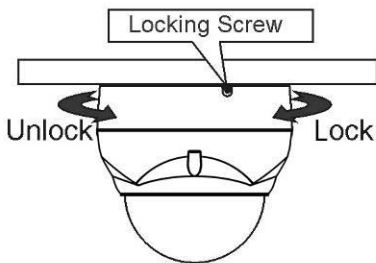

Figure E

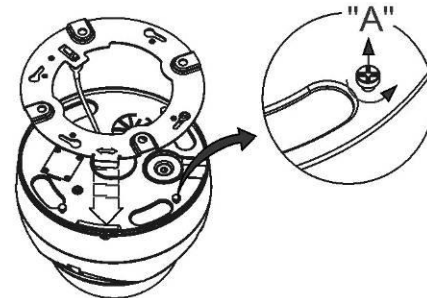

Figure F

**CAUTION:** Before installing mounting bracket to surface pre-adjust the four mounting screws "A" on the base of the dome camera to best match the mounting bracket locked position. Unscrew the locking screw on the side of the dome's base and fit the tab of the mounting bracket into the locking slot. Screws "A" should not be too tight or too loose when the dome is in the locked position. After setting the proper positions of screws "A" remove the mounting bracket and install it to the proper surface. If it is too difficult to lock the dome in position after the mounting bracket has been installed readjust the screws "A" by unscrewing them a small amount and try to install dome camera again.

## 2.2.2 Heater Kit Installation (Optional)

1. Assemble the Heater board to two bosses with screws.

Take it to a reference "B" in the bottom case as below.

2. Place the Heater in the slot "A".

Heater cable should be placed away from the Main Board.

3. Plug the power connector to the socket "C" (J1) of the Heater Board.

4. 24VAC is recommended to use for the camera power for stable operation with heater kit.

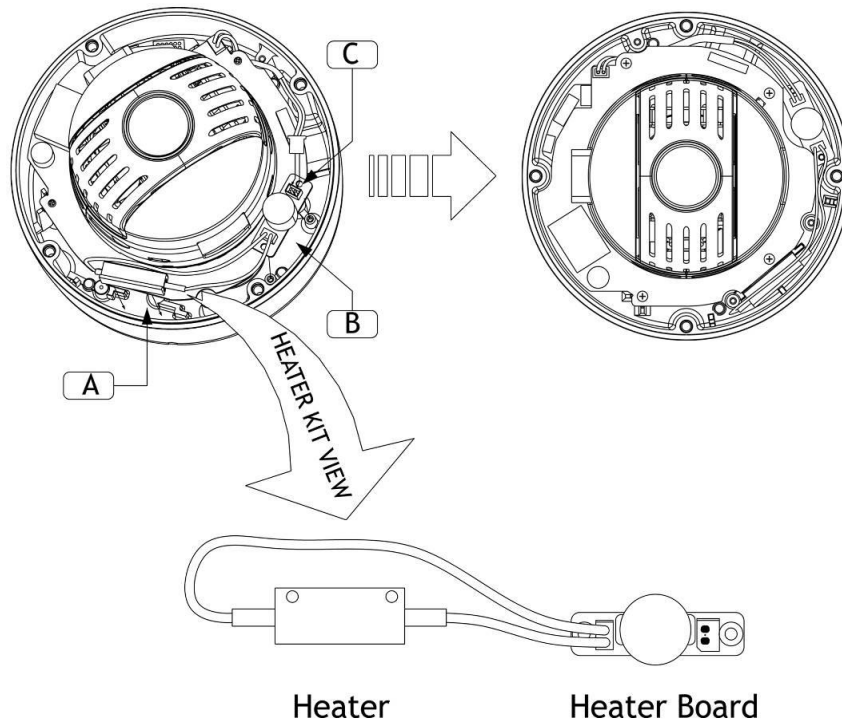

### • HEATER (IF APPLICABLE)

Power Supply	24VAC
Power Consumption	10W
Heater ON	at 59°F (15°C)
Heater OFF	at 77°F (25°C)

### • POWER

Use satisfy clause 2.5 of IEC60950-1/UL60950-1 or Certified/Listed Class 2 power source only.

**CAUTION 1:** Dehumidify after installing the heater kit. Otherwise, moisture may be generated at certain temperatures. Then close the cover tightly to ensure waterproofing.

**CAUTION 2:** Please reset the camera after 30 minutes when installing it in situations colder than -10°C.

## 2.3 Basic Configuration of Dome Camera System

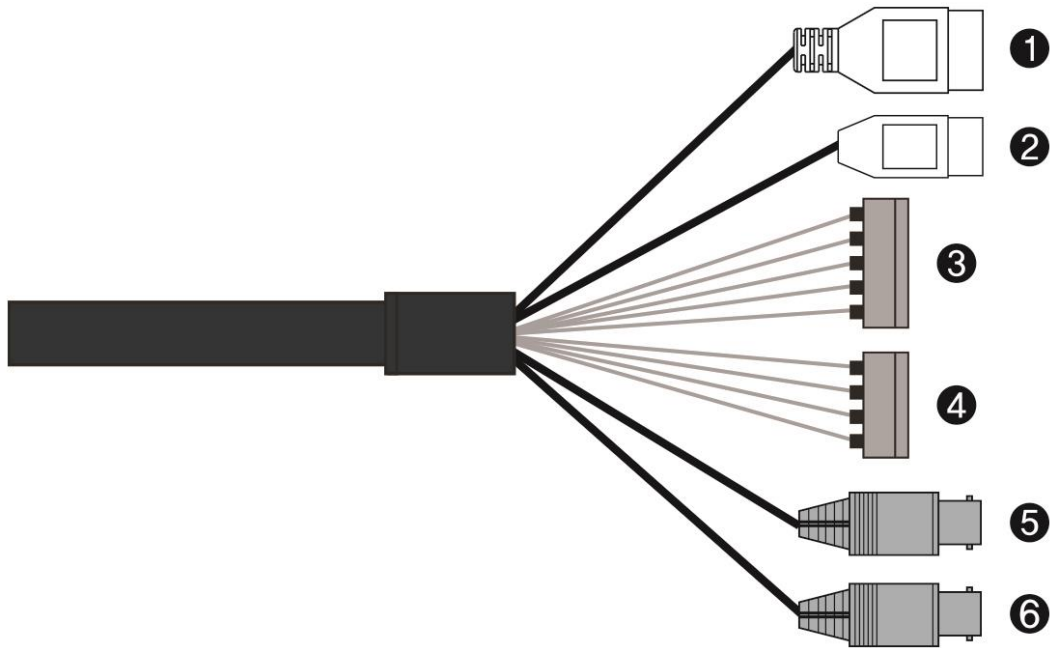

No.	Type	Description
1	3-PIN TERMINAL BLOCK	CAMERA POWER
2	2-PIN TERMINAL BLOCK	TX+: RS485+ (A)
		TX-: RS485- (B)
3	5-PIN TERMINAL BLOCK	A1: ALARM INPUT 1
		A2: ALARM INPUT 2
		A3: ALARM INPUT 3
		A4: ALARM INPUT 4
		GND
4	4-PIN TERMINAL BLOCK	AO1: ALARM OUTPUT 1
		GND
		AO2: ALARM OUTPUT 2
		GND
5	BNC BLACK	HD OUTPUT
6	BNC YELLOW	CVBS OUTPUT

The dome camera must be installed by qualified service personnel in accordance with all local and federal electrical and building codes.

## 2.4 Setting Dome Camera (DIP Switch)

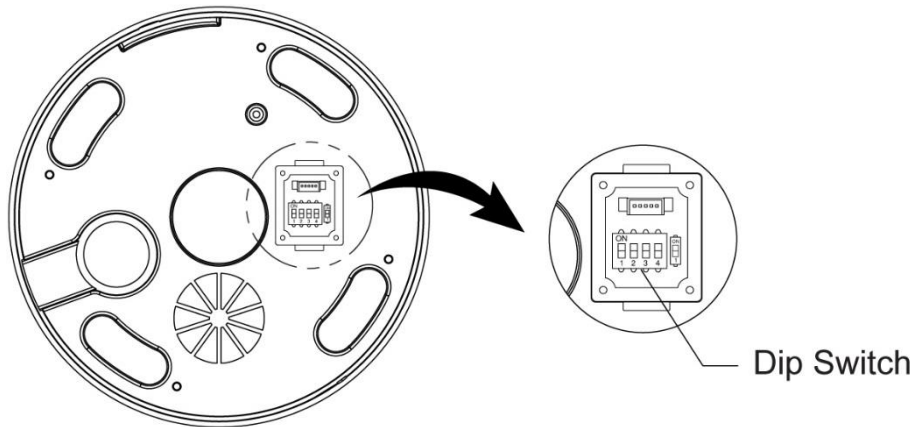

**NOTE:** Open the DIP switch cover and change the setting of DIP switch.  
After changing the setting, close the cover tightly to ensure waterproofing.

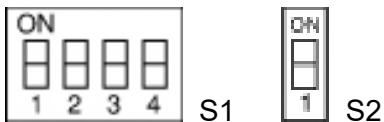

You can set video signal with D1 and video type with D2 in S1.

S1-D1	Video Signal
OFF	HD-TVI Output
<b>ON</b>	AHD Output

S1-D2	Video Type
OFF	NTSC
<b>ON</b>	PAL

You can set coaxitron protocol with D3 and D4 in S1.

S1-D3	S1-D4	HD-TVI Output	AHD Output
OFF	OFF	Hikvision-C	ACP-PTZ
<b>ON</b>	OFF	Pelco-C	Reserved
OFF	<b>ON</b>	Reserved	Reserved
<b>ON</b>	<b>ON</b>	Reserved	Reserved

You can set CVBS output with D1 in S2.

S2-D1	CVBS Output
OFF	When WDR is on, CVBS output will be disabled.
<b>ON</b>	CVBS output will be displayed always. (DWDR)

## 2.5 Setting Dome Camera Address (ID)

To prevent damage, each dome camera must have a unique address (ID). The factory default setting is 1.

Refer to '3.10 Dome Communication' section for detailed information.

## 2.6 Connections

### • Connecting to the RS-485

The dome camera can be controlled remotely by an external device or control system, such as a control keyboard, using RS-485 half-duplex serial communications signals.

### • Connecting HD Output connector

Connect the HD output (BNC) connector to the video input.

### • Connecting CVBS Output connector

Connect the CVBS output (BNC) connector to the video input.

### • Connecting Alarms

#### - A1,A2,A3,A4 (Alarm Input 1,2,3,4)

You can use external devices to signal the dome camera to react on events. Mechanical or electrical switches can be wired to the A1,A2,A3,A4 (Alarm Input 1,2,3,4) and G (Ground) connectors.

See Chapter 3 — Program and Operation for configuring alarm input.

#### - G (Ground)

**NOTE: All the connectors marked G or GND are common.**

Connect the ground side of the alarm input and/or alarm output to the G (Ground) connector.

#### - AO1,AO2 (5VTTL Alarm Output 1,2)

The dome camera can activate external devices such as buzzers or lights. Connect the device to the AO1,AO2 (Alarm Output 1,2) and G (Ground) connectors.

See Chapter 3 — Program and Operation for configuring alarm output.

### • Connecting the Power

Connect power of 12VDC or 24VAC for the dome camera.

When using a 12VDC adapter, connect the positive (+) pole to the '+' position and the negative (-) pole to the '-' position.

Use satisfy clause 2.5 of IEC60950-1/UL60950-1 or Certified/Listed Class 2 power source only.

24VAC is recommended to use for the camera power for stable operation with heater kit. If using 12VDC, the heater will not operate at all.

## 2.7 Getting Started

Once installed apply power to the dome camera. The dome camera will start a configuration sequence.

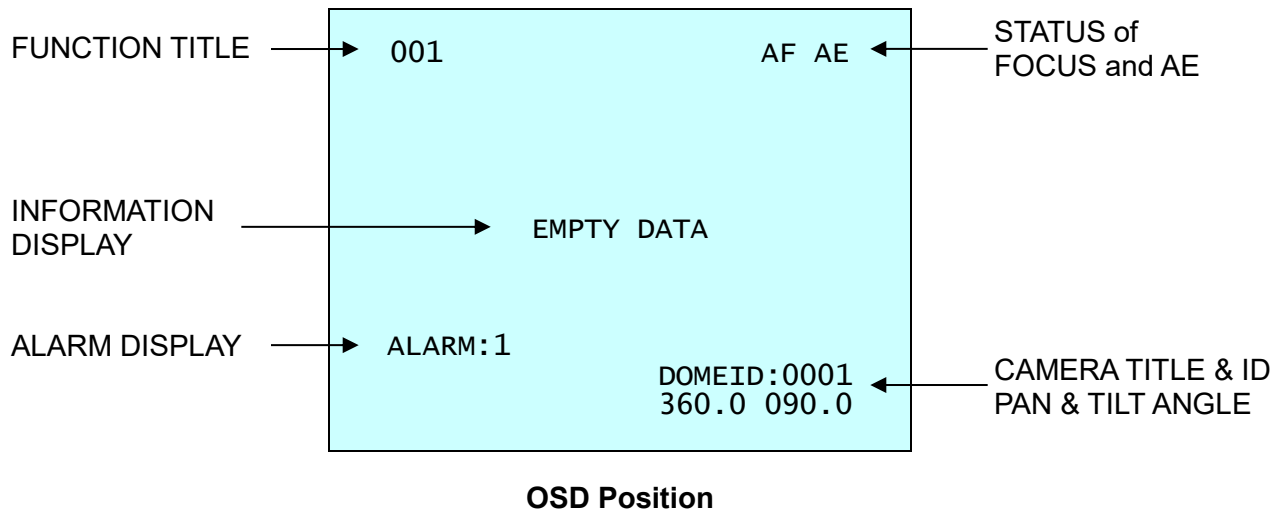

# Chapter 3 — Program and Operation

## 3.1 Dome Camera Selection

IF you use the keyboard, before you program or operate a dome camera, you must select the dome camera by pressing **No.** + **CAM** keys.

**Example:** Pressing **1** , **0** + **CAM** keys sequentially will select dome camera 10. The selected dome camera ID will be displayed on the LCD monitor of the keyboard.

## 3.2 Accessing the On-Screen Menu Utility

You can call up the On-screen menu utility on your monitor by pressing the **MENU** key on the keyboard or DVR, the following On-screen menu utility will appear:

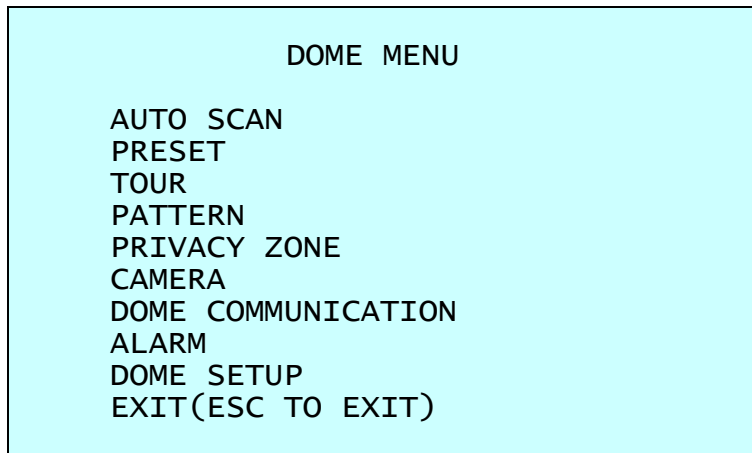

## 3.3 How to control the On-Screen Menu Utility

Function	Button
Call the On-screen menu utility.	<b>MENU</b>
Navigate through the menu items.	<b>Up</b> or <b>Down</b>
Go into the sub-menu items.	<b>Right</b> , <b>Left</b> or <b>IRIS Open</b>
Change value. Enter the editing title mode.	<b>Right</b> , <b>Left</b> , <b>Tele</b> or <b>Wide</b>
Enter the changing angle mode.	<b>IRIS Open</b>
Exit the changing angle mode.	<b>IRIS Close</b>

### 3.4 Auto Scan

The Auto Scan supports up to 17 programmed angles at user-programmable speeds.

```

                AUTO SCAN SETUP

NUMBER          : 01
TITLE           : A01
MODE            : NORMAL
SPEED           : 5 STEP
START ANGLE     : -----
END ANGLE      : -----
SCAN DIR        : CCW
SWAP            : OFF
DWELL           : 03 SEC
FOCUS           : AUTO
SAVE AND EXIT(ESC TO CANCEL)
    
```

- NUMBER** 01 ~ 08, 10 ~ 17, **09**: AUTO-PAN mode (endless panning)
- TITLE** up to 6 characters
- MODE** NORMAL, VECTOR, RANDOM (AUTO-PAN mode: NORMAL, RANDOM only)
  - NORMAL Move from start point to end point in panning only
  - VECTOR Move from start point to end point including tilt and zoom simultaneously and linearly.
  - RANDOM Move randomly between the start point and the end point
- SPEED** 1 ~ 13 step, the lower number means the slower speed.
- SCAN DIR** Set the Scan direction, CCW (Counter Clock Wise), CW (Clock Wise).
- SWAP** Swaps the start point for the end point.
- DWELL** Set the dwell time at the both end, 01 ~ 99 seconds.
- FOCUS** AUTO, MANUAL

Follow these steps to program Auto Scan:

1. Press the **MENU** key to display the main menu on the monitor. Scroll to Auto Scan and press the **Right** key.
2. Select “**NUMBER**” and set the desired number by pressing the **Right** or **Left** key.
3. Select “**TITLE**” and press the **Tele** or **Wide** key to enter the title edit mode.
4. Press the **Tele** or **Wide** key to change the alphanumeric characters and move the next position by pressing the **Right** or **Left** key. Or move down to the character table and press the **IRIS Open** key at the desired character then the cursor position moves to the next position automatically. Press the **Right** or **Left** key at the “ALL DELETE” field to delete all characters. Press the **Right** or **Left** key at the “EXIT” field to finish title edit menu.

```

                TITLE EDIT MENU
                (CTRL KEY)

A01
$

A B C D E F G H I J
K L M N O P Q R S T
U V W X Y Z 0 1 2 3
4 5 6 7 8 9 ( )
ALL DELETE
EXIT(ESC TO EXIT)
    
```



5. Select **"MODE"** and **"SPEED"**.
6. Select **"START ANGLE"**. Press the **IRIS Open** key then the "CONTROL" displays. Move the desired position and the zoom position. Press the **IRIS Close** key then the "CONTROL" disappears. To adjust at the 0.1 degree interval, press the **Tele** or **Wide** key at the pan field and the tilt field. To adjust at the one zoom interval, press the **Tele** or **Wide** key at the zoom field.
7. Select **"END ANGLE"**. Press the **IRIS Open** key then the "CONTROL" displays. Move the desired position and the zoom position. Press the **IRIS Close** key then the "CONTROL" disappears. To adjust at the 0.1 degree interval, press the **Tele** or **Wide** key at the pan field and the tilt field. To adjust at the one zoom interval, press the **Tele** or **Wide** key at the zoom field.
8. Set **"SCAN DIR"** to CCW or CW.
9. Select **"SWAP"**, Set to ON to exchange the start angle and the end angle.
10. Set **"DWELL time"**.
11. Set **"FOCUS"**.
12. Select **"SAVE AND EXIT"** and press the **Right** or **IRIS Open** key. Press the **IRIS Close** key to exit the program without saving.

### 3.5 Preset

If you need to view specific places routinely, you should program Presets. A Preset is a programmed video scene with automatic pan, tilt, zoom, focus, and AE settings. In addition, Presets may be assigned the “home” position for the dome camera. As many as 240 Presets, whose positions are saved in the dome camera’s firmware, may be programmed.

There are eight pages of Preset menu. Each page has 30 Presets. Pages can be scrolled by pressing the **Right** or **Left** key on the first or last No. of Preset.

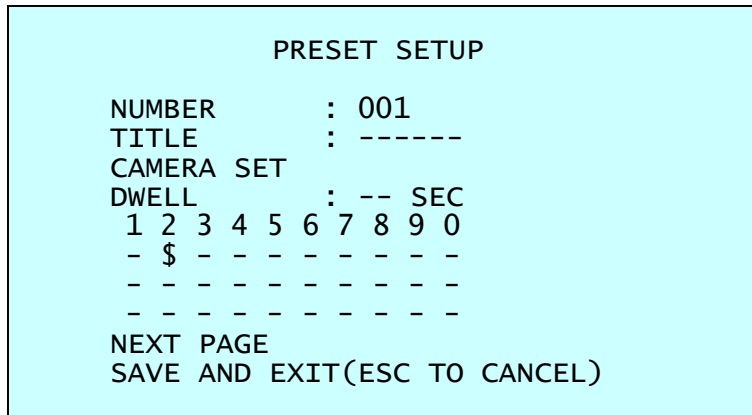

- Blank Preset position
- \$ Position has the Preset
- ! Current cursor position

Follow steps below to store the Preset positions:

1. Press the **MENU** key to display the main menu on the monitor. Scroll to Preset and press the **Right** key.
2. Select the blank Preset position to be stored by pressing the **Up**, **Down**, **Right** or **Left** key.
3. After selecting a blank position, press the **IRIS Open** key. Use the **Up**, **Down**, **Right**, **Left**, **Tele** or **Wide** key to control the direction of the camera and lens.
4. After aiming the camera (view direction and lens control), press the **IRIS Close** key. The cursor will be on the “**TITLE**” after saving data then press the **Tele** or **Wide** key to edit the Preset title. Follow the procedure of the Auto Scan above to edit titles.
5. Select “**CAMERA SET**” and press the **Right** or **Left** key. Then the Preset camera setup displays.

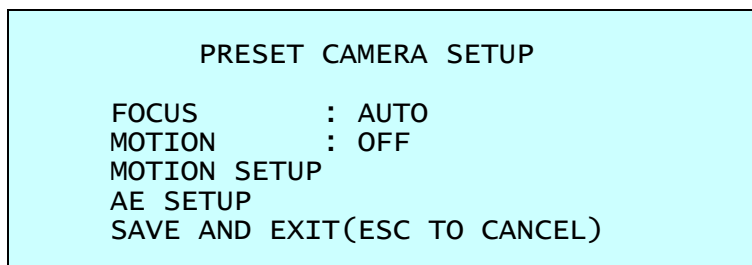

- Set **FOCUS** AUTO, MANUAL, ONE PUSH
- Set **MOTION** OFF, ON

Select "**MOTION SETUP**" and press the **Right** or **Left** key. Then the MOTION setup displays.

MOTION SETUP	
SENSITIVITY	: 10
POSITION	: ALL
DELAY	: 00 SEC
OUTPUT	: OFF
HOLD TIME	: 03 SEC
EXIT(ESC TO EXIT)	

Set <b>SENSITIVITY</b>	00 ~ 20
Set <b>POSITION</b>	ALL, CENTER
Set <b>DELAY</b>	00 ~ 05 seconds
Set <b>OUTPUT</b>	OFF, OUT1, OUT2
Set <b>HOLD TIME</b>	03 ~ 99 seconds

Select "**AE SETUP**" and press the **Right** or **Left** key. Then the AE setup displays. Refer to the AE SETUP in the camera setup.

6. Set "**DWELL time**". (03 ~ 99 seconds)
7. To select the next page of Presets, scroll the page by pressing the **Right** or **Left** key on the first or last columns of the menu.
8. Repeat step 2 through 7 for each additional Preset position.
9. Select "**SAVE AND EXIT**" and press the **Right** or **IRIS Open** key. Press the **IRIS Close** key to exit the program without saving.

### 3.6 Tour

There are 8 programmable Tours. Each Tour consists of up to 40 Preset positions, Patterns, Scans or other Tours (second-level). Using second-level Tours, it can be expanded to over 300 functions in a single Tour.

```

          TOUR SETUP

NUMBER           : 01
TITLE            : T01
SCAN TYPE       : NORMAL
SPEED           : -- STEP
TOUR FUNCTION
SAVE AND EXIT(ESC TO CANCEL)
  
```

```

          TOUR FUNCTION SETUP
                    (CTRL KEY)
DWEELL           : -- SEC
003 A04 --- --- ---
--- --- --- ---
--- --- P01 --- ---
--- T02 --- --- ---
--- --- --- ---
--- --- --- ---
--- --- --- ---
--- --- --- ---
EXIT(ESC TO EXIT)
  
```

---	Blank position
SCAN TYPE	NORMAL, VECTOR
DWEELL	03 ~ 99 seconds
003	Preset (1 ~ 240)
A04	Auto Scan (1 ~ 8, 10 ~ 17)
P01	Pattern (1 ~ 8)
T02	Tour (1 ~ 8)

Follow the steps below to program the Tours:

1. Press the **MENU** key to display the main menu on the monitor. Scroll to Tour and press the **Right** key to enter the Tour menu.
2. Select "NUMBER" and set the desired number by pressing the **Right** or **Left** key.
3. Select "TOUR FUNCTION" and press the **Right** key to enter the Tour Function Setup menu.
4. Choose a blank position to be programmed by pressing the **Up**, **Down**, **Right** or **Left** key.
5. To add a stored Preset, press the **Tele** or **Wide** key then the stored Preset number displays.
6. To place functions other than Preset, press the **IRIS Open** key to scroll for Tour, Pattern or Auto Scan respectively.
7. You can also overwrite the programmed number and remove a stored number from the Tour, press the **IRIS Open** key until '---' is displaying in the position.
8. Repeat step 2 through 6 for each desired position. Each title will be displayed on top of the line.
9. To edit the "TITLE", follow the procedure of the Auto Scan above to edit titles.
10. Select "SAVE AND EXIT" and press the **Right** or **IRIS Open** key. Press the **IRIS Close** key to exit the program without saving.

You can expand the Tour sequence by calling other programmed Tours.

**NOTE: The speed applies in the vector mode only.**

**NOTE: In the Tour mode, in conjunction with Preset and Auto Scan, you can make the camera travel from a Preset position to another Preset position at a specific speed.**

**Example:** Preset 001>002>003>004>005>006, Auto Scan 01 starts at Preset 002, ends at Preset 003, Auto Scan 02 starts at Preset 005, ends at Preset 006;  
Tour 001, 002, A01, 004, A02.

1 → 2 2~3 → 4 → 5~6, repeat  
where → : Quick move, ~ : Programmed speed

**To assign the functions other than Preset in the Tour when the function key is not existed:**

Move the cursor to a stored Preset position.

Pressing the **IRIS Open** key will change the Preset number to other function (Auto Scan, Pattern, Tour or Preset) with the first programmed number.

To change the number, press the **Tele** or **Wide** key.

### 3.7 Pattern

The Pattern feature records user control of the selected dome camera. Up to 8 Patterns can be stored and played back by pressing **No.** + **PTRN** keys subsequently.

PATTERN SETUP (CTRL KEY)			
NO	TITLE	SEC	PERCENT
1	: P01	000	00.0%
2	: P02	000	00.0%
3	: P03	000	00.0%
4	: P04	000	00.0%
5	: P05	000	00.0%
6	: P06	000	00.0%
7	: P07	000	00.0%
8	: P08	000	00.0%
SAVE AND EXIT(ESC TO CANCEL)			

Follow steps below to program the Pattern:

1. Press the **MENU** key to display the main menu on the monitor. Scroll to Pattern and press the **Right** key to enter the Pattern menu.
2. Select the desired Pattern to be programmed by pressing the **Up** or **Down** key. If the Pattern is not 000, a Pattern has already been recorded. Patterns can be overwritten.
3. Press the **IRIS Open** key then the "CONTROL" displays. Move the position and the zoom position. Press the **IRIS Close** key then the "CONTROL" disappears.
4. To edit the "TITLE", follow the procedure of the Auto Scan above to edit titles.
5. Select "SAVE AND EXIT" and press the **Right** or **IRIS Open** key. Press the **IRIS Close** key to exit the program without saving.

**NOTE: If Pattern recording time reaches 500 seconds, it will automatically stop for a moment.**

### 3.8 Privacy Zone

Hide up to 16 unwanted scenes in a camera.

There are four pages of Privacy Zone menu. Each page has 4 Privacy Zones.

PRIVACY ZONE SETUP (CTRL KEY)			
NO		METHOD	COLOR
01	ON	BLOCK	BLACK
02	ON	BLOCK	BLACK
03	OFF	-----	BLACK
04	OFF	-----	BLACK
NEXT PAGE			
SAVE AND EXIT(ESC TO CANCEL)			

1. Place the cursor at the field.
2. Press the **IRIS Open** key then the privacy area menu displays. Move the desired position. Press the **IRIS Close** key then the "CONTROL" disappears.

To adjust the size, press the **Tele** or **Wide** key.

Returns to the previous menu.

PRIVACY AREA MENU (CTRL KEY)	
NUMBER 01	
354.8	344.8
EXIT(ESC TO EXIT)	

3. To turn the stored zone ON or OFF, press the **Tele** or **Wide** key.
4. Set the "COLOR": "BLACK", "WHITE", "YELLOW", "CYAN", "GREEN", "MAGENTA", "RED" or "BLUE".
5. Select "SAVE AND EXIT" and press the **Right** or **IRIS Open** key. Press the **IRIS Close** key to exit the program without saving.

### 3.9 Camera Menu

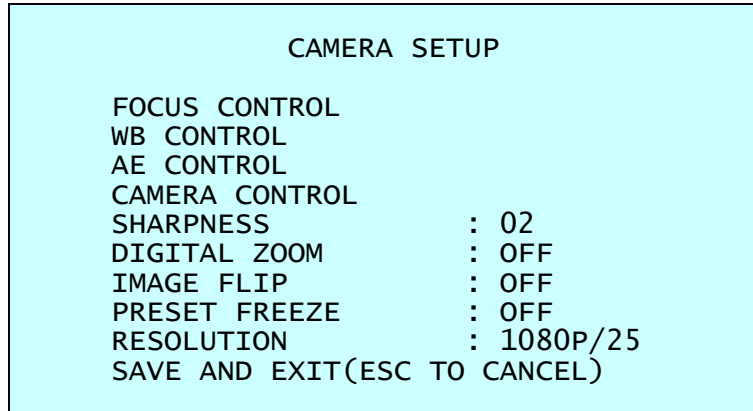

- SHARPNESS** The higher the value, the more edges in the picture will be enhanced.  
(0 ~ 10)
- DIGITAL ZOOM** OFF: Zoom range is limited to the optical.  
2X: Zoom is extendable up to 2X of digital range.  
4X: Zoom is extendable up to 4X of digital range.  
8X: Zoom is extendable up to 8X of digital range.  
MAX: Zoom is extendable Max digital zoom range.
- IMAGE FLIP** This function turns the video output from the camera upside down and reverses it horizontally.  
**This option is helpful to install in the opposite side.**
- PRESET FREEZE** ON: the image is frozen during calling Preset.
- RESOLUTION** HD-TVI Output: 1080P/30, 1080P/25, 720P/60, 720P/50, 720P/30, 720P/25  
AHD Output: 1080P/30, 1080P/25

#### • FOCUS CONTROL

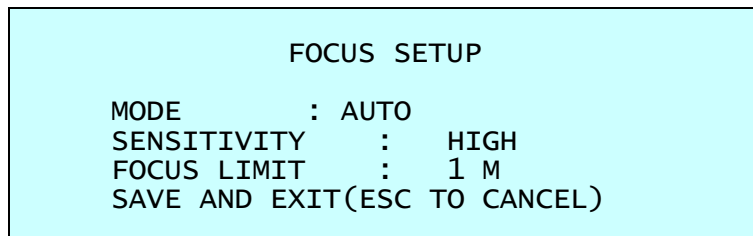

- MODE** AUTO, MANUAL, ONE PUSH, CONSTANT MANUAL  
Use manual mode in normal use.
- SENSITIVITY** LOW, LOW.MID, MID, MID.HIGH, HIGH
- FOCUS LIMIT** This distance is approximate value and the focus operates from the setting value.

**CAUTION: Avoid continuous, 24-hour use of the auto focus. This will shorten the lifespan of the lens.**



• **WB (White Balance) CONTROL**

```

WB SETUP

MODE           : AUTO
R GAIN        : ---
B GAIN        : ---
SAVE AND EXIT(ESC TO CANCEL)
    
```

**MODE** AUTO, MANUAL, INCANDESCENT, FLUORESCENT, OUTDOOR

- AUTO Computes the white balance value output using color information from the entire screen automatically.
- INCANDESCENT Auto white balance mode that is compatible with incandescent lamps.
- FLUORESCENT Auto white balance mode that is compatible with fluorescent lamps.
- OUTDOOR Outdoor white balance mode
- MANUAL Manual mode, you can change R and B Gain manually.

R GAIN 0 ~ 255  
 B GAIN 0 ~ 255

R GAIN / B GAIN modes are controllable only in MANUAL Mode.

• **AE CONTROL**

```

AE SETUP

MODE           : AUTO
DSS            : OFF
IRIS           : AUTO
SHUTTER        : AUTO
BRIGHT         : 10
GAIN LIMIT     : 07
NIGHT SHOT     : AUTO
ADDITIONAL AE
SAVE AND EXIT(ESC TO CANCEL)
    
```

**MODE** AUTO, MANUAL, I.PRIO, S.PRIO

- AUTO Auto exposure mode
- MANUAL Variable Iris, Shutter speed
- I.PRIO Variable Iris, Auto Shutter speed
- S.PRIO Variable Shutter speed, Auto Iris

**DSS** OFF, x2 ~ x8  
**IRIS** F1.8 ~ F32  
**SHUTTER** 1/25 (30) ~ 1/30000  
**BRIGHT** 0 ~ 20  
**GAIN LIMIT** 0 ~ 7  
**NIGHT SHOT** AUTO, ON, OFF, GLOBAL

**NOTE:** Values in ( ) are for NTSC Camera.

The NIGHT SHOT option removes the IR cutoff filter of the camera and makes the camera sensitive to near infrared.

**AUTO** Camera goes in to B&W mode at low light.  
**GLOBAL** Controlled by the keyboard

**(NOTE: GLOBAL function operates F2E protocol only)**

The operator can enable NIGHT SHOT for all dome cameras at the same time.

If the NIGHT SHOT mode is set to GLOBAL, "999" + **ENTER** will turn Off the NIGHT SHOT mode and "888" + **ENTER** will turn On the NIGHT SHOT mode.

**ON** B/W mode  
**OFF** Color mode

**NOTE: AUTO in NIGHT SHOT function is not applied in "MANUAL" mode of AE Control.**

**ADDITIONAL AE**

ADDITIONAL AE SETUP	
WDR	: OFF
WDR WEIGHT	: --
BLC	: OFF
HLC	: OFF
HLC LEVEL	: --
HLC COLOR	: ---
DEFOG	: OFF
EXIT(ESC TO EXIT)	

**WDR** OFF, ON, NIGHT OFF (**NOTE: When ON, BLC will be disabled.**)  
**WDR WEIGHT** LOW, MID, HIGH  
**BLC** OFF, ON (**NOTE: When ON, WDR will be disabled.**)  
**HLC** OFF, ON  
**HLC LEVEL** 0 ~ 20  
**HLC COLOR** BLACK, WHITE, YELLOW, CYAN, GREEN, MAGENTA, RED, BLUE  
**DEFOG** OFF, ON

**• CAMERA CONTROL**

CAMERA CONROL	
D/N LEVEL	: MID
D/N DELAY	: 03 SEC
CHROMA	: 06
GAMMA	: 2
DNR	: MID
DIS	: OFF
SAVE AND EXIT(ESC TO CANCEL)	

**D/N LEVEL** LOW, MID, HIGH  
**D/N DELAY** 1 ~ 60 seconds  
**CHROMA** 0 ~ 20  
**GAMMA** 0 ~ 4  
**DNR** OFF, LOW, MID, HIGH  
**DIS** OFF, ON

### 3.10 Dome Communication

To prevent damage, each dome camera must have a unique address (ID).  
The factory default setting is 1.

```

                                DOME COMMUNICATION
                                $
DOME ID       : 0001
PROTOCOL      : AUTO
BAUDRATE      : 9600
PARITY        : NONE
TERMINATION   : OFF
SAVE AND EXIT(ESC TO CANCEL)

```

- DOM ID**                                    1 ~ 3999
- PROTOCOL**                                AUTO, F2/F2E, PELCO-PD
- BAUDRATE**                                2400, 4800, 9600, 19200, 38400 bps
- PARITY**                                    NONE, EVEN, ODD
- TERMINATION (RS-485)**                    OFF, ON

The device which is connected at end of line, whether it is a dome camera or keyboard, must have the cable for communication terminated by setting the appropriate DIP switch. Without proper termination, there is potential for control signal errors. Total length of the cable for communication should not exceed 4000 ft (1.2 km).

### 3.11 Alarm

```

                ALARM SETUP
                (CTRL KEY)
NO PRI FUN IN  OUT  HOLD LATCH
1  1  001 NO  OUT1 03  OFF
2  1  --- OFF OFF  03  OFF
3  1  --- OFF OFF  03  OFF
4  1  --- OFF OFF  03  OFF
DWELL      : 03 SEC
ALARM OUT SETUP
SAVE AND EXIT(ESC TO CANCEL)

```

- NO (Number)** Alarm input number
- PRI (Priority)** The lower number has higher priority. (0 ~ 4)
- FUN (Function)** Stored function number to be called by alarm.
- IN (Input)** NO/NC – normally open/closed, OFF – ignore
- OUT (Output)** OUT1 ~ OUT2 – 5VTTL output, OFF – no output
- HOLD** Alarm will be held for programmed time. (03 to 99 seconds)
- LATCH** ON – Alarm message will remain on the screen even though alarm input is deactivated.  
OFF – Alarm message will disappear from the screen after programmed hold time when alarm input is deactivated.
- DWELL** Means the dwell time during multiple alarms, 03 to 99 seconds.

```

                ALARM OUT SETUP

OUT1  : ALARM
OUT2  : 1 MIN
EXIT(ESC TO EXIT)

```

**ALARM:** Alarm output is operated during an alarm operation or by the short key of the keyboard.

**1 ~ 5 MIN (minute):** Alarm output is operated during this setting time only by the function run of the dome menu or the short key of the keyboard.

**NOTE: This 1 ~ 5 MIN setting is not operated by an alarm.**

There are 5 levels of priority. The function can be selected by Preset, Auto scan, Pattern or Tour and “0” is the highest priority. Lower priority alarms won’t be serviced until the higher priority alarm is completed. Equal priority alarms will be serviced repeatedly with the dwell time.

## 3.12 Dome Setup

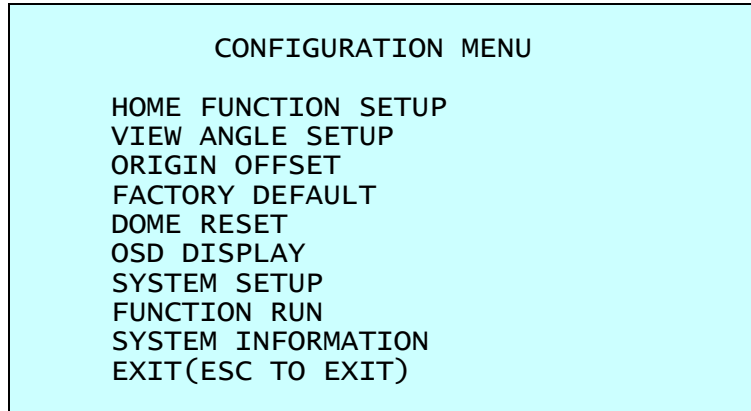

### • HOME FUNCTION SETUP

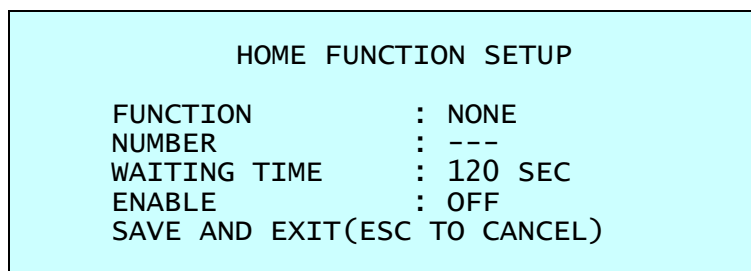

<b>FUNCTION</b>	NONE, TOUR, PATTERN, AUTO SCAN, PRESET
<b>NUMBER</b>	---
<b>WAITING TIME</b>	10 ~ 240 seconds
<b>ENABLE</b>	ON, OFF

The Home Function can be set so that the camera automatically goes to Tour, Pattern, Auto Scan or Preset after the keyboard or DVR has been idle for a specified amount of time.

For example, if the controller is idle for 120 seconds, the camera goes to Preset 1.

Follow these steps to program the Home position:

1. Select “**FUNCTION**” by pressing the **Right** or **Left** key to scroll through the None, Tour, Pattern, Auto Scan or Preset functions.
2. Select “**NUMBER**” and press the **Right** or **Left** key. The recorded function number will scroll.
3. Select “**WAITING TIME**” and press the **Right** or **Left** key to select from 10 to 240 seconds.
4. Select “**ENABLE**” and turn to ON or OFF by pressing the **Right** or **Left** key.

## • VIEW ANGLE SETUP

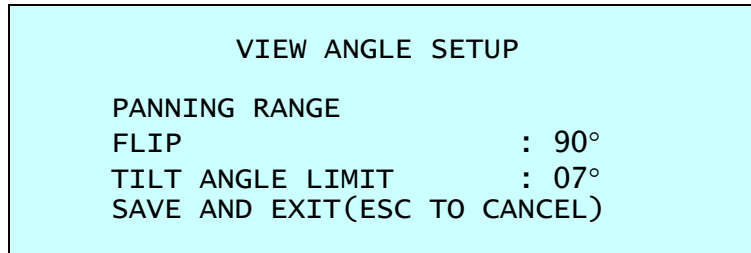

**FLIP** OFF, AUTO, 90°, 100°, 110°, 120°

**OFF:** The dome camera moves until 90° vertically.

**AUTO:** When the camera reaches the floor directly above the moving object, it will stop.

At that time, release the controller instantly and pull it down again to run the auto-flip function. When you use the panning range, it is recommended to use the flip mode to AUTO.

**90°, 100°, 110°, 120°:** Allows the image to flip digitally when the camera moves over the setting angle vertically.

**TILT ANGLE LIMIT** -10° ~ 10°

This option is designed to limit the view angle as there is some obstruction in zooming out on specific areas of the tilt angle.

**NOTE:** Focus issues may occur in certain conditions.

## PANNING RANGE

When the dome camera is installed near a wall, panning range can be limited by user.

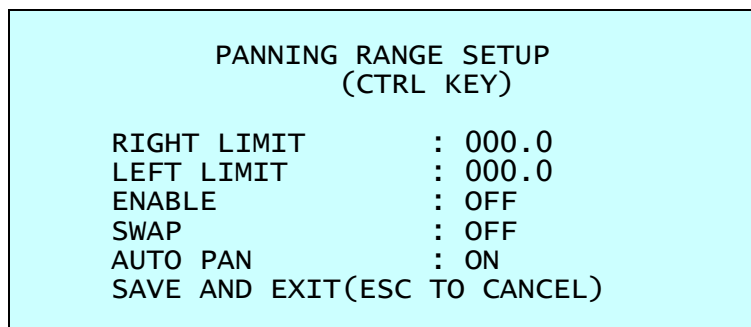

1. Place the dome camera under 90 degree vertically.
2. Set "**RIGHT LIMIT**" by pressing the **Right** key.
3. Set "**LEFT LIMIT**" by pressing the **Left** key.
4. Set "**ENABLE**" to ON to use.

To exchange the right and the left limit, set "**SWAP**" to ON.

To apply limits on the auto pan (endless panning), set "**AUTO PAN**" to ON.

**NOTE:** When the flip mode is 90°, 100°, 110° or 120° and you moves over 90° vertically, the panning range operates in opposite side.

- **ORIGIN OFFSET**

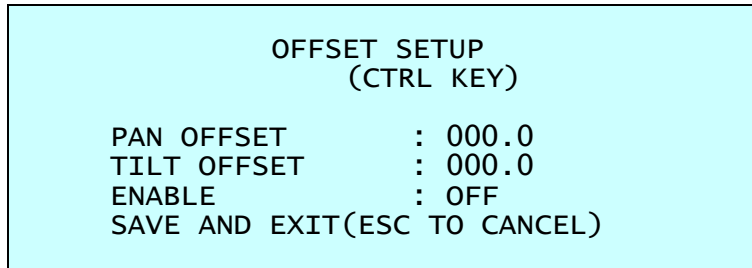

This feature is useful to align a new dome camera exactly the same as the previously installed dome camera.

Dome camera's origin set and all data initialize option do not override offset values. Only the default set option in this menu will set the offset value to zero. This can be used to avoid ceiling obstructions.

- **FACTORY DEFAULT**

Select "**FACTORY DEFAULT**" to initialize the data.

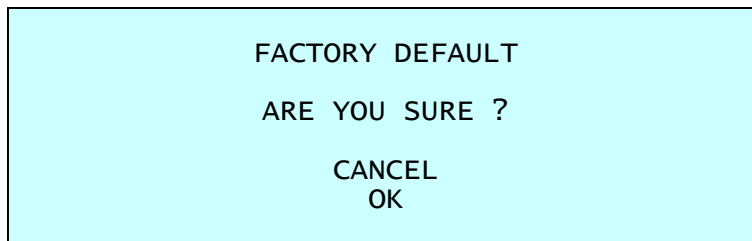

- **DOMES RESET**

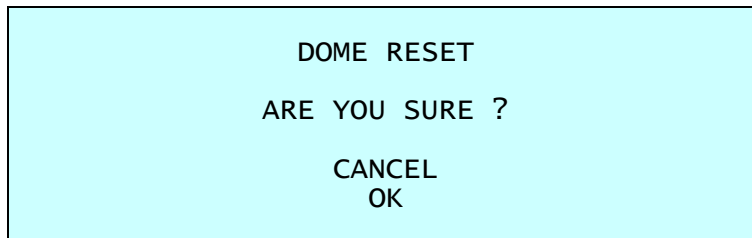

This feature is used to re-calibrate the orientation of a selected dome camera. Origin offset value is not affected by this function. (Offset is still valid after origin set.)

• **OSD DISPLAY**

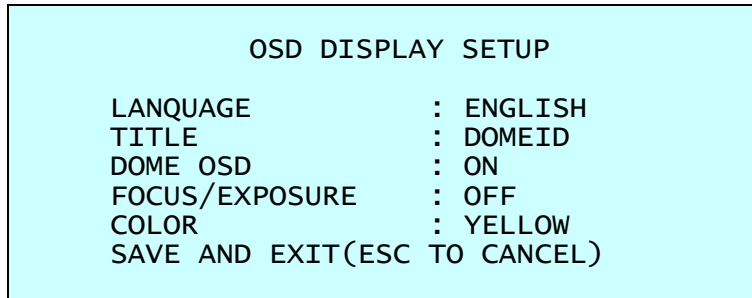

- LANGUAGE**                    Select the desired language.
- TITLE**                        up to 6 characters
- DOME OSD**                    ON, POSITION, ON(ZOOM), ZOOM, TILTE&ID, OFF  
All display or title will disappear when DOME OSD DISPLAY is set to OFF.
- FOCUS/EXPOSURE**            ON, OFF  
ON: FOCUS and EXPOSURE displays. (AF AE)
- COLOR**                        YELLOW, GREEN, BLUE

• **SYSTEM SETUP**

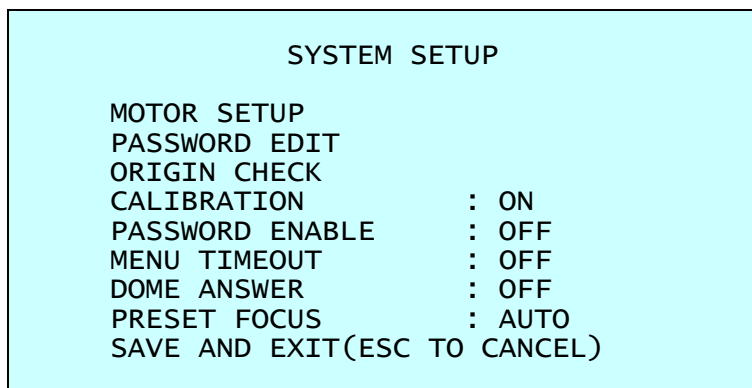

- CALIBRATION**                ON (Auto origin check), OFF
- PASSWORD ENABLE**        ON (requires the password to enter menu), OFF
- MENU TIMEOUT**            ON (5 minutes), OFF (always menu display)
- DOME ANSWER**            ON, OFF (no acknowledge command from the dome)  
This option is helpful to escape the collision of the command using some DVR.
- PRESET FOCUS**            AUTO, MANUAL, ONE PUSH  
This option set the default mode of the focus when you save the Preset.



## MOTOR SETUP

Motor Setup menu provides the pan and tilt speed of a camera. User can set the desired speed with pressing the **Right** or **Left** key.

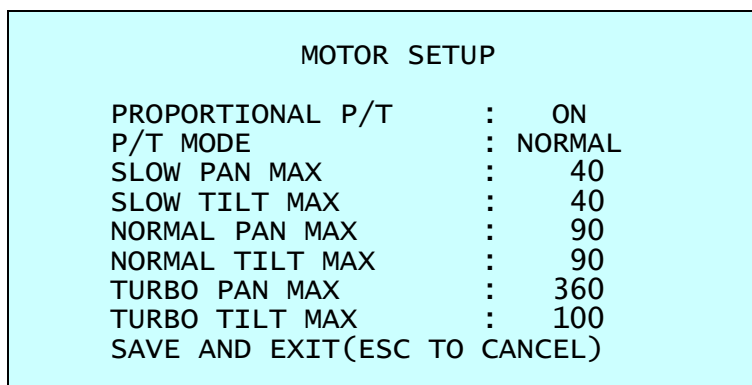

### PROPOTIONAL P/T

ON, OFF

### P/T MODE

SLOW, NORMAL, TURBO

SLOW PAN Maximum speed	19° ~ 90°/second
SLOW TILT Maximum speed	19° ~ 90°/second
NORMAL PAN Maximum speed	40° ~ 360°/second
NORMAL TILT Maximum speed	40° ~ 200°/second
TURBO PAN Maximum speed	200° ~ 380°/second
TURBO TILT Maximum speed	90° ~ 300°/second

## PASSWORD EDIT

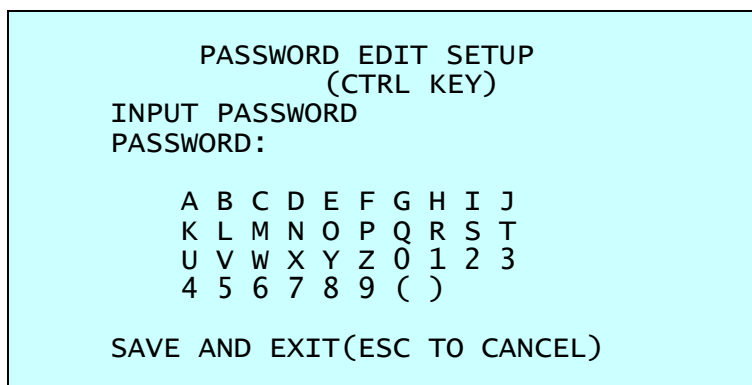

You can change the password with 6-digit character in this menu.

The default password is **555555**.

When the password enable is on, the input password window displays to enter the menu. At this time, move the cursor to the desired character with the controller and press the **IRIS** **Open** key.

## ORIGIN CHECK

If you find the dome camera in the wrong position during operation, execute this origin check and the dome camera will return to the right position after the origin check operation.

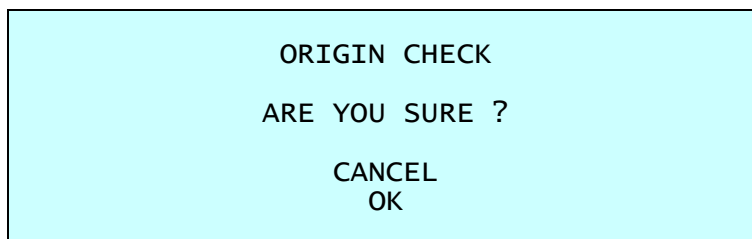

## • FUNCTION RUN

This Function Run menu allows you to execute the function when you use the keyboard or DVR without the function keys (Preset, Pattern, Tour and Scan).

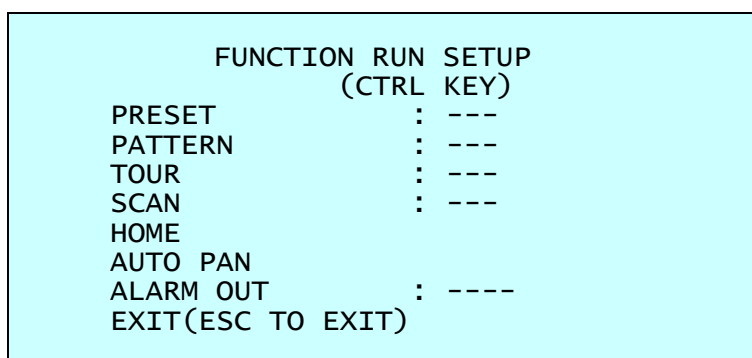

1. Select the desired Function by pressing the **Up** or **Down** key.
2. Select the number by pressing the **Tele** or **Wide** key in PRESET, PATTERN, TOUR and SCAN.
3. Press the **IRIS Open** key to execute.

**NOTE: To execute the function, you should save the function (PRESET, PATTERN, TOUR and SCAN) first.**

### - HOME

Select "HOME" and press the **IRIS Open** key. The dome camera goes to the default position that it returns to after an assigned period of inactivity passes. The default position may be a Preset, Tour, Pattern or no action.

### - AUTO PAN

You can execute the endless auto pan to turn in one direction continuously by selecting Auto-Pan.

### - ALARM OUT

This function can operate only when the alarm out setup has the time in the alarm menu.

Ex)

```
ALARM OUT SETUP

OUT1  : ALARM
OUT2  : 1 MIN
EXIT(ESC TO EXIT)
```

You press the **IRIS Open** key then that alarm out operates during the setting time only.

#### • SYSTEM INFORMATION

```
SYSTEM INFORMATION

CAMERA TYPE      : xxxx-Vx.xx
H/W VERSION     : Vx.xx-xxxx
ROM VERSION      : Vx.xxxxxxx
PROTOCOL         : xxxx
BAUDRATE        : 9600(NONE)

EXIT(ESC TO EXIT)
```

The system information provides essential information about the dome camera if service is required. This screen displays the camera type and ROM version. The information on this screen cannot be modified.

## Appendix A — Specifications

<b>IMAGE</b>	
Lens	Optical Zoom 20X 4.7 ~ 94mm
Angle of View	55.5 ~ 3° (H)
Image Sensor	1/2.8" SONY STARVIS CMOS sensor
Min. Illumination	Color : 0.35 Lux @ 50IRE BW : 0.013 Lux @ 50IRE
Scanning Mode	Progressive Scan
Wide Dynamic Range	True WDR
Day and Night Mode	True D/N (Auto, Day, Night)
Noise Reduction	2DNR, 3DNR
Digital Zoom	16X
Exposure Control	Auto, Manual, Shutter Priority, Iris Priority
White Balance Control	Auto, Manual, Incandescent, Fluorescent, Outdoor
Back Light Compensation	Yes
Image Effect	Flip, Defog, DIS, BLC, HLC
Shutter Speed	25/30fps : Auto (1/30,000 ~ x8 sec.), Manual 50/60fps : Auto (1/50,000 ~ x8 sec.), Manual
<b>VIDEO</b>	
Resolution	HD-TVI : 1080p @ 25/30fps, 720p @ 25/30/50/60fps AHD : 1080p @ 25/30fps
Video Output	HD-TVI or AHD, Composite
<b>PTZ Function</b>	
Pan Range	360° Endless
Pan Speed	Max. 380°/sec. (Preset)
Tilt Range	-10 ~ 190°
Tilt Speed	Max. 380°/sec. (Preset)
Auto Scan	1 Auto Pan & 16 Auto Scans
Preset	240
Tour	8
Pattern	8
Home Function	Yes
Privacy Mask Zone	16 Programmable Zones
<b>EXTERNAL IN/OUT</b>	
Video HD Output	BNC Jack
Video Composite Output	BNC Jack
Alarm	4 Inputs, 2 Outputs (Terminal Block)
Control	Coaxial Communication RS-485, Baud Rate: 2400 ~ 38400 bps (Default: 9600 bps)
ID (Camera Address)	1 ~ 3999

ETC	
Operating Humidity	0 ~ 90%RH (Non-condensing)
Operating Temperature	-20 ~ 50°C
Operating Temperature (with Heater)	-30 ~ 50°C
Power Supply	12VDC, 24VAC
Power Supply (with Heater)	24VAC
Power Consumption	1A (12W) @ 12VDC, 24VAC
Power Consumption (with Heater)	1.5A (22W) @ 24VAC
Dimensions	See dimension drawing
Net Weight	Approx. 1.6kg
Ingress Protection	IP66

\* Specifications are subject to change without notice \*

UNIT : mm

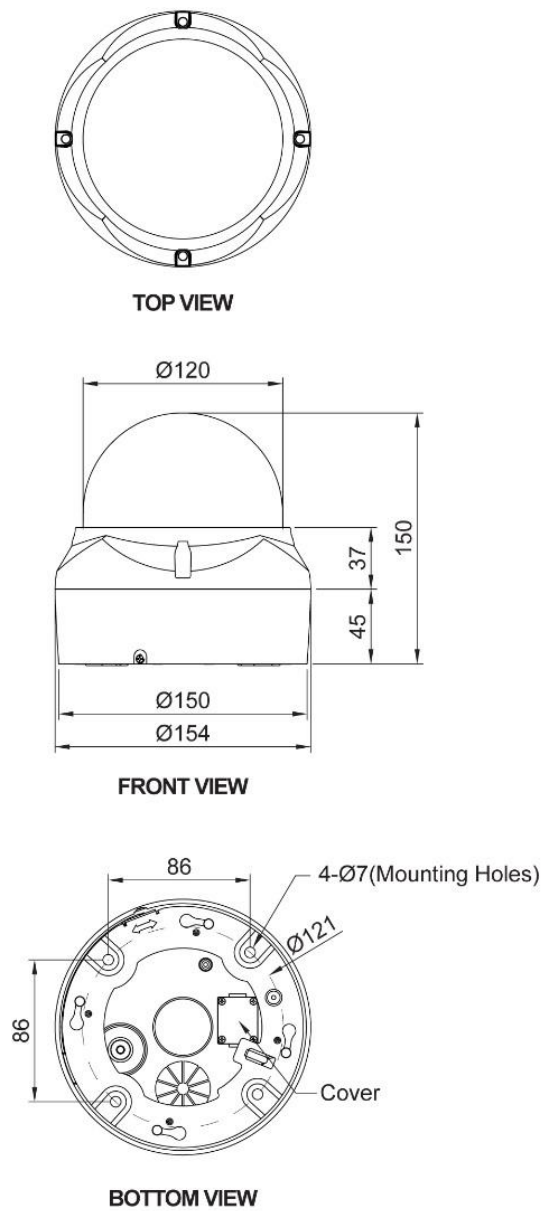

Figure – Dimension

## Appendix B — Troubleshooting

If problems occur, verify the installation of the camera with the instructions in this manual and with other operating equipment. Isolate the problem to the specific piece of equipment in the system and refer to the equipment manual for further information.

Problem	Possible Solution
No video.	Verify that power is connected to all pieces of equipment in the system. Verify that the power switches are in the ON position. Check the video connections.
Poor video quality.	Check that the BNC connectors are inserted properly. Check the voltage level of the dome camera. Cable for video is shielded.
Dome cameras lose their positions.	Reset the cameras using the Dome configuration menus. Check that the dome cameras are inserted properly in the base. Check the voltage level of the dome camera.





eneo® is a registered trademark of  
VIDEOR E. Hartig GmbH  
Exclusive distribution through special-  
ised trade channels only.

VIDEOR E. Hartig GmbH  
Carl-Zeiss-Straße 8  
63322 Rödermark/Germany  
Tel. +49 (0) 6074 / 888-0  
Fax +49 (0) 6074 / 888-100  
[www.videor.com](http://www.videor.com)  
[www.eneo-security.com](http://www.eneo-security.com)

Technical changes reserved

© Copyright by VIDEOR E. Hartig  
GmbH Version 01/2020