



EN

User Manual

**1/2.8" HD Dome, Fixed, WDR,
Day&Night, 1920x1080, 12V,
Infrared, 2.8-12mm, Indoor**

MPD-62M2812P0A

Safety Precaution

- To prevent fire or shock hazard, do not expose the unit to rain or moisture.
- To prevent electric shocks and risk of fire hazards, do NOT use other than specific power source.

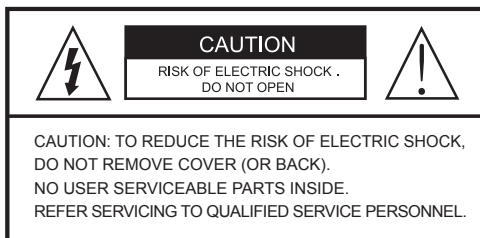

The symbol is intended to alert the user to the presence of uninsulated "dangerous voltage" within the product's enclosure that may be of sufficient magnitude to constitute a risk of electric shock to persons.



The symbol is intended to alert the user to the presence of important operating and maintenance(servicing) instructions in the literature accompanying the unit.

• Warning :

This equipment has been tested and found to comply with the limits for a Class A digital device, pursuant to part 15 of the FCC Rules. These limits are designed to provide reasonable protection against harmful interference when the equipment is operated in a commercial environment. This equipment generates, uses, and can radiate radio frequency energy and, if not installed and used in accordance with the instruction manual, may cause harmful interference to radio communications. Operation of this equipment in a residential area is likely to cause harmful interference in which case the user will be required to correct the interference at his own expense.

• Caution :

Any changes or modifications in construction of this device which are not expressly approved by the party responsible for compliance could void the user's authority to operate the equipment.

Mains power quality should be that of a typical commercial environment. If the user of the model requires continued operation during power mains interruptions, it is recommended that the model be powered from an uninterruptible power supply (UPS) or a battery.

Safety Precaution

NOTICE

- The image used in this instruction manual are processed to help comprehension and may differ from actual video of the camera.
- Avoid installing areas where has shock or vibration which results in the problems.
- Pay attention to safety when laying the connection cable and observe that the cable is not subjected to heavy loads, kinks or damage and no moisture can get in.
- The warranty becomes void if repairs are undertaken by unauthorized persons. Maintenance and repair have to be carried out only by authorized service centers.
- Use only a mild detergent to clean the housing.
- The camera should never be operated beyond the technical specifications. This can lead to destruction.
- The camera should never be operated in water.

Contents

p.03~04

Safety Precaution

p.05

Contents

p.06

Features

p.07

Composition

p.08

Dimensions

p.09

Part Names

p.10~12

Installation Instructions

p.13~29

Operating Instructions

p.30

Specifications

Features

Key Features

- Full-HD 2Mega pixel CAMERA, 1920x1080(30p/25p)
- The best low light performance with SONY's STARVIS sensor
- Video output EX-SDI 1.0,2.0 / HD-SDI / TVI mode / AHD mode / CVI mode or CVBS Selectable
- TVI mode / AHD mode / CVI mode, Video Transmission Distance over Coax.; 500M
- f=2.8~12mm F1.4, 5Mega pixel Motorized zoom lens
- Automatically removable IR Cut filter by Dual filter switcher
- SNAP Focus by Motorized Zoom lens
- Motorized Zoom & Focus Adjustment
- Sensitivity of Color 0.08 Lux(LED off), B/W 0.005 Lux (LED off)
- True WDR (Wide Dynamic Range), 30/25fps
- ROI (Region of Interest) WDR mode:
 - Proper compensation of exposure for each inside and outside of interested area.
 - Better contrast and No motion ghost effect
- Improved Noise figure with the enhanced 3D-NR
- Motion Detection, Privacy Mask, Defog, Sens-up(~x32), ACE(D-WDR), Sharpness, Mirror/Flip, BLC/HLC, Anti-Saturation, Smart IR, Title Set
- Top performance at low light sensitivity (Sens-up On)
- Selectable Digital output 1080p or 720p
- OSD Menu & Video Sub-out port for easy installation & maintenance
- Circuit protection against faulty connection in power polarity
- UTC control through HD-TVI (Pelco-C, Hikvision) / AHD
- Built-in 2pcs High power LED
- Double side Anti-scratch Hard coated bubble dome
- Quick installation with Easy Adaptor (Flat or Tilted Adaptor)

Composition

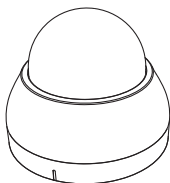

Dome Camera



Mounting Template



Operating Instruction

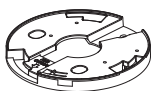

Easy Adaptor
(Flat type)

Plastic Anchor:
6 x 30mm (3pcs)



Mounting Screw:
3.5 x 25mm (3pcs)

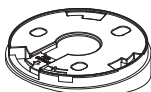

Easy Adaptor
(Tilted type)

Open Driver (1pc)

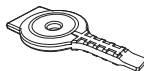

Video Sub-out Cable

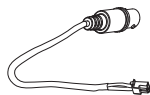

Dimensions

(unit : mm)

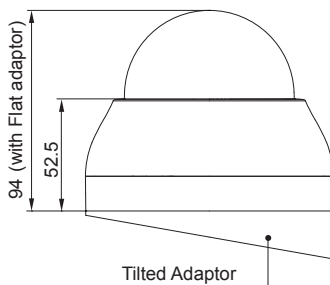
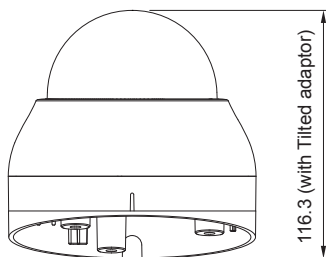
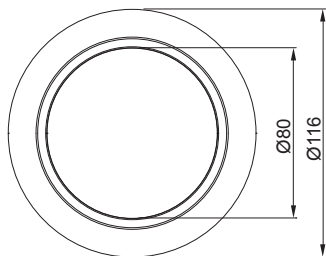

CAUTION

- Extreme care should be taken NOT to scratch the bubble dome surface while the camera installing or adjusting.
- Care should be taken the cable is NOT to be damaged, kinked or exposed in the hazardous area.
- Do not expose the camera directly to a strong light source such as the sun or spot light.

Part Names

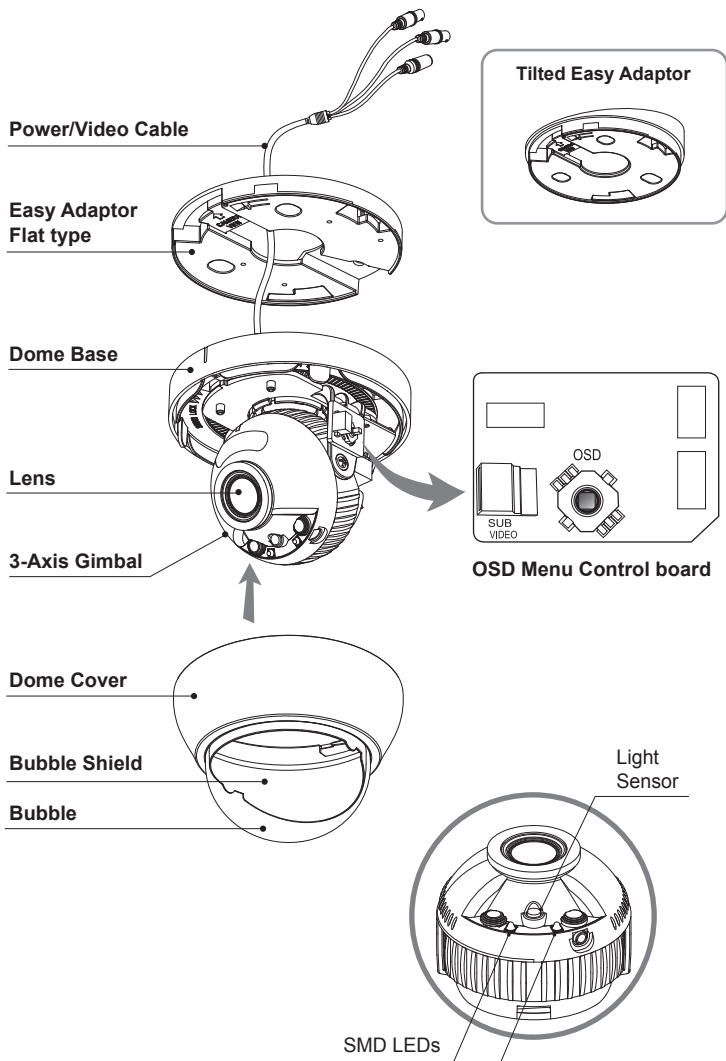

Installation Instructions

1. Drill three holes for mounting on the ceiling or wall.
2. Place the Easy Adaptors at the pre-drilled installation position and fix it by using mounting screws.
3. Route the power/video cable to the connecting place.
4. Attach the dome base assembly to the Easy Adaptor.
5. Adjust the camera's viewing angle (Pan, Tilt, Rotation)
6. Assemble the dome cover to the dome base unit.

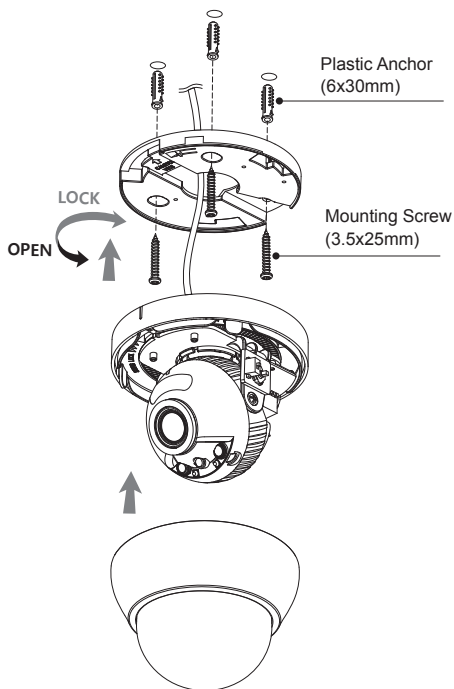

CAUTION

- Be careful the LEDs when you control the OSD setting with the joystick.
- Remove the sticker on the gimbal after the OSD setting



Installation Instructions

Limit of pan & tilt

1) Pan limit:

Pan is limited to $\pm 165^\circ$.

Do NOT force to rotate the gimbal over the limit to prevent from the internal damage.

2) Tilt limit:

Tilt is limited to 25° min ~ 90° max. with reference to the ceiling when the inclination of camera module is 0° , that is, the image is aligned horizontally.

3) Inclination limit

(Horizontal image alignment):
Inclination limited to $\pm 60^\circ$ max.

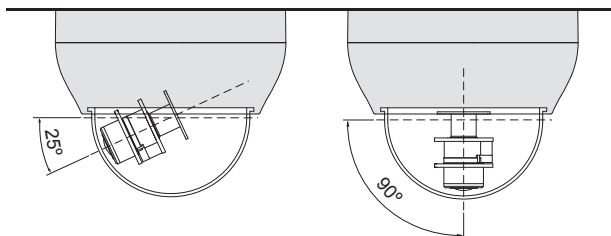
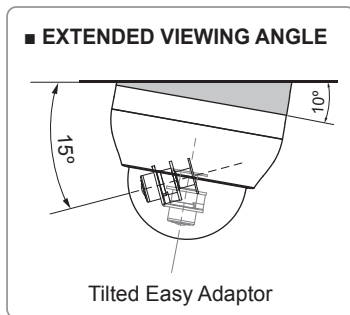

■ Detach the dome camera from the easy adaptor

Push the hook on the dome base and swing the dome base to counter-clock wise. Then detach the dome camera from the installed easy adaptor.

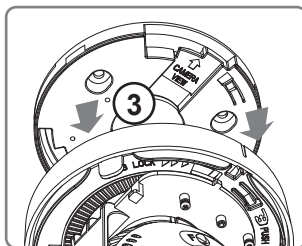
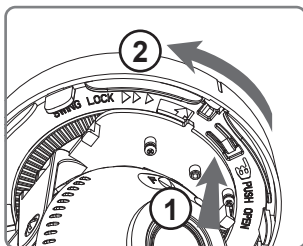

Installation Instructions

■ Open the dome cover

- ① Insert wide side of Open Tool into the lock of Dome Cover.
- ② Hold the Dome housing with one hand and turn the open tool until Dome Cover is sufficiently open.
- ③ Once Dome Base and Dome Cover are detached, press the edge of Dome Cover and pull it down with hands.

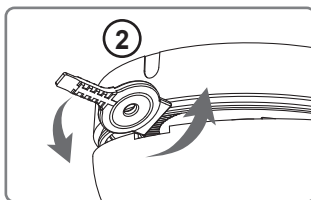
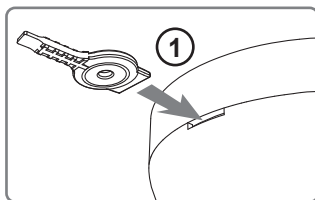

Power Supply Connections

Camera can be operated with the regulated or unregulated 12VDC but the regulated power supply of 12VDC is recommended.

Camera is protected from the damage by the reverse connection of polarity.

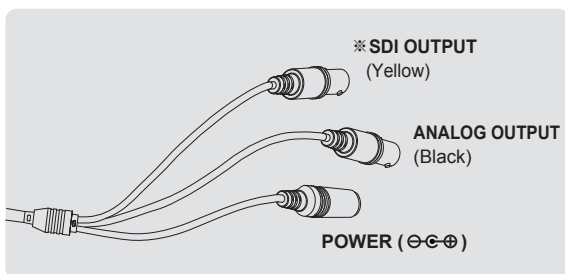

- ※ Please use the cable as provided with camera. If camera cable is cut and re-wired, the transmission distance of video can be reduced. Especially SDI cable should not be cut because it requires detailed wiring job and affects the transmission distance.

Operating Instructions

Using OSD Controller

Setup menu can be accessed and controlled by OSD control joy stick on the side of the gimbal. Five commands are available with the joy stick. The design of OSD could be different according to the Model.

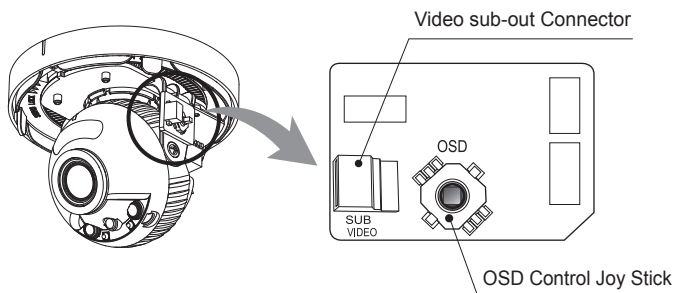

◆ Description of the OSD control operation

- 1) SET Key (●) : Access to the menu or enter the setting.
To enter the main menu, press the Set Key down.
- 2) UP/DOWN Key (▲/▼) : Choose the desired sub-menu and to move the cursor up or down.
- 3) LEFT/RIGHT Key (◀/▶) : Set up the value of the selected menu. Used to adjust the desired menu selection and to move the cursor left or right.
- 4) '👉' denotes the long press down straightly for about 2 seconds

◆ Description of the Motorized ZOOM&FOCUS* adjustment

(* Works only when OSD Menu is inactive.



- | | |
|-----------------|-------------------|
| 1) ▲ : Zoom In | 3) ◀ : Focus Near |
| 2) ▼ : Zoom Out | 4) ▶ : Focus Far |

※ ANALOG OUT0 should be set to TVI MODE, AHD MODE or CVI MODE to get CVBS video in sub-out. If it is set to CVBS, there is no CVBS video in sub-out port. (SYSTEM> OUTPUT> ANALOG OUTPUT0)

※ If CVBS video is enabled through ANALOG OUT0 or Sub-out port, WDR and 3D-NR functions are disabled in all video outputs. It should be considered when installer adjusts the video with installation monitor via CVBS video signal.

Operating Instructions

OSD menu Table

MENU	SUB MENU	CONFIGURATION			
LENS	DC	MODE (INDOOOR, OUTDOOR, DEBLUR)			
	MANUAL				
ZOOM / FOCUS	AF MODE	ZOOMPUSH, MANUAL			
	MODE CHANGE	ENABLED, DISABLED			
	SCANNING	HALF, FULL			
	ONEPUSHAF	ON 			
	SYNC TDN	ON, OFF			
	INITIAL	ON 			
EXPOSURE	BRIGHTNESS	0~20			
	SHUTTER	AUTO	MODE (INDOOR, OUTDOOR, DEBLUR)		
		MANUAL (SPEED)	1/30(1/25), 1/60(1/50), 1/120(100), 1/250(200), 1/500(400), 1/1000(800), 1/2000(1600), 1/4000(3200), 1/8000(6400), 1/15000(12800), 1/30000(25600)		
		FLICKERLESS			
	SENS-UP	OFF, x2, x4, x8, x16, x32			
	AGC	0~10			
BACKLIGHT	OFF				
	HLC	LEVEL, COLOR			
	BLC	H/V-POS, H/V-SIZE			
	WDR	MODE	ROI	WINDOW ZONE/USE, H/V-POS, H/V-SIZE	
			NORMAL		
	WEIGHT	MIDDLE, HIGH, LOW			
DAY & NIGHT	EXTERN	SMART IR, ANTI-SAT., DELAY, IR LED CTL (AUTO, OFF)			
	AUTO	SMART IR, ANTI-SAT., AGC THRES, AGC MARGIN, DELAY			
	COLOR				
	B&W	SMART IR, ANTI-SAT.			
COLOR	AWB	AUTO, AUTOext, PRESET, MANUAL (C-TEMP, R/B-GAIN)			
	COLOR GAIN	0~20			
3D-NR	OFF, LOW, MIDDLE, HIGH				
IMAGE	SHARPNESS	MAIN OUTPUT	ANALOG OUT0	ANALOG OUT0	TVI MODE, AHD MODE, CVBS, CVI MODE
				TVI MODE	0~10
				AHD MODE	0~10
				CVI MODE	0~10

Operating Instructions

IMAGE	SHARPNESS	MAIN OUTPUT	ANALOG OUT1	ANALOG OUT1	CVBS
				SDI&CVBS	0~10
		SDI OUTPUT	SDI OUT	HD-SDI, EX-SDI 1.0, EX-SDI 2.0, OFF	
			SDI&CVBS	0~10	
	GAMMA	0.45, 0.55, 0.65, 0.75			
	MIRROR	OFF, ON			
	FLIP	OFF, ON			
	ACE	OFF, LOW, MIDDLE, HIGH			
	DEFOG	OFF, ON	MODE (AUTO, MANUAL) LEVEL (LOW, MIDDLE, HIGH)		
	PRIVACY	OFF, ON	ZONE NUM, ZONE DISP, H/V-POS, H/V-SIZE, Y LEVEL, CB/CR LEVEL, TRANS		
MOTION	OFF, ON	DET WINDOW	WINDOW ZONE, WINDOW USE, DET H/V-POS, DET H/V-SIZE		
		DET TONE	0~4		
		MDRECT FILL	OFF, ON		
		SENSITIVITY	0~10		
		MOTION OSD	OFF, ON		
		TEXT ALARM	OFF, ON		
SYSTEM	OUTPUT	SDI OUTPUT	HD-SDI, EX-SDI 1.0, EX-SDI 2.0, OFF		
		ANALOG OUT0	TVI MODE, AHD MODE, CVBS, CVI MODE		
	RESOLUTION	1080 30P(25P), 720 30P(25P), 720 60P(50P)			
	TV SYSTEM	US(NTSC), EU(PAL)			
	LANGUAGE	ENG, CHN(S), CHN, JPN, KOR, GER			
	CAM TITLE	OFF, RIGHT UP, LEFT DOWN			
	RESET	ON 			
EXIT	SAVE, CANCEL				

Operating Instructions

OSD menu Startup

Press the 'OSD menu SET key' down to access the setup menu mode.

- EXIT : Enters 'EXIT' menu with save current setting or without save.
- RETURN : Returns to the previous menu.

MENU V0. XX	
1. LENS	DC ↓
2. ZOOM/FOCUS	↓
3. EXPOSURE	↓
4. BACKLIGHT	OFF
5. DAY&NIGHT	EXTERN ↓
6. COLOR	↓
7. 3D-NR	MIDDLE
8. IMAGE	↓
9. MOTION	OFF
A. SYSTEM	↓
B. EXIT	SAVE ↓

1. LENS

Lens can be selected either DC or MANUAL lens.
It should be selected according to lens type.

1-1. DC : DC is for the best image when DC Auto iris Vari-focal lens is installed.

- MODE : Selects MODE according to lighting condition.
 - INDOOR: Optimized of indoor environment.
 - OUTDOOR: Optimized of outdoor environment.
 - DEBLUR: It enables to reduce the blur in a certain indoor environment.
Noise or color rolling can be increased.

1-2. MANUAL : MANUAL is for the best image when Fixed lens is installed.

2. ZOOM/FOCUS

2-1. AF MODE

- ZOOMPUSH: Focusing works steadily for sharp focusing on the object.
In the case of a Motor driven lens, focusing resumes in about 7~8 seconds to save the lens lifetime when the focus gets lost.
- MANUAL: Focusing can only be adjusted by ▲, ▼ of OSD control joystick.



Operating Instructions

2. ZOOM/FOCUS

AF MODE	ZOOMPUSH
MODE CHANGE	DISABLED
SCANNING	HALF
ONEPUSHAF	ON 
SYNC TDN	OFF
INITIAL	ON 
RETURN	↓

AF MODE Changes to MANUAL automatically after 3 hrs when MODE CHANGE is ENABLED.

2. ZOOM/FOCUS

AF MODE	MANUAL
MODE CHANGE	NOT USED
SCANNING	HALF
ONEPUSHAF	ON 
SYNC TDN	OFF
INITIAL	ON 
RETURN	↓

2-2. MODE CHANGE (Available only with AF MODE is ZOOMPUSH)

MODE CHANGE is activated to set ZOOMPUSH in AF MODE.

It is for locking of the lens control to prevent undesirable operation.

- **ENABLED** : Locks and disables the lens operation after 3 hours.
It is recommended to maintain the working-life of the motorized zoom lens.
- **DISABLED** : Disables the locking feature allowing lens operation at any time.

2-3. SCANNING

Lens scanning can be set to performs HALF or FULL on the screen.

Scanning checks the positions for zoom/focus at both of the end positions and saves them for the references.

2-4. ONEPUSHAF

Focusing is activated only when zoom in/out is working.

2-5. SYNC TDN

Compensates for IR correction when the camera switches to DAY or NIGHT.

It is recommended to set OFF except specific conditions.

2-6. INITIAL



Lens initialization is necessary during the installation or the regular operation to align the position data with the mechanical positions whose lens elements may move and deviate from its calibrated position by the shock or vibration, for example, during the transportation. Lens initialization is automatically executed at power up.

INITIAL starts the lens initialization when pressing the joystick straight down for about 2 sec. It is strongly necessary to execute LENS INIT in cases below;

- At the final step for the installation.
- When focus becomes out of control by the shock or vibration.

Operating Instructions

3. EXPOSURE

3. EXPOSURE	
BRIGHTNESS	9 
SHUTTER	AUTO
SENS-UP	X2
AGC	7 
RETURN	↵

3-1. BRIGHTNESS

Adjusts the brightness of video (0~20).

3-2. SHUTTER

Selects AUTO or set manually.

If SHUTTER set to MANUAL modes, SENS-UP mode is inactivated.

3-2-1. AUTO: Optimizes the video level by controlling the iris and the shutter speed automatically.

- MODE : Selects MODE according to lighting condition.
 - INDOOR: Optimized of indoor environment.
 - OUTDOOR: Optimized of outdoor environment.
 - DEBLUR: It enables to reduce the blur in a certain indoor environment. Noise or color rolling can be increased.

3-2-2. MANUAL : 1/30(1/25), 1/60(1/50), 1/120(100), 1/250(200), 1/500(400), 1/1000(800), 1/2000(1600), 1/4000(3200), 1/8000(6400), 1/15000(12800), 1/30000(25600) Shutter can be set to fix.

3-2-3. FLICKERLESS : Flicker is used to remove the flickering on screen due to differences in light and electric frequencies.

3-3. SENS-UP

The brighter video can be obtained by increasing the exposure time in the night with SENS-UP. It can be set to Off, x2, x4, x8, x16 or x32.

Higher setting can get the brighter video but the slower frame rates with more white pixels.

3-4. AGC

AGC(0~10) amplifies the video gain for brighter video but noise and white pixel accordingly.

Operating Instructions

4. BACKLIGHT

Compensates the video image to cut out the highlight area with mask or control the contrast of video. It can be set the compensation level or areas.

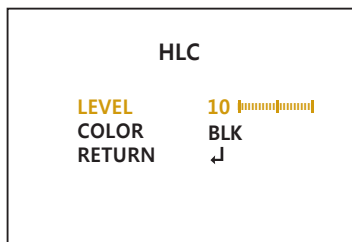

4-1. HLC (High Light Compensation)

Cuts out the highlight area with mask and excludes it from compensation.

4-1-1. LEVEL (0~20): Sets the HLC level. It determines the video level that starts cutting out. Lower setting starts the cut out at lower level.

The cut out area is masked with selected color.

4-1-2. COLOR : Select mask color from 9 colors.

Black, White, Yellow, Cyan, Green, Magenta, Red, Blue and Customize.

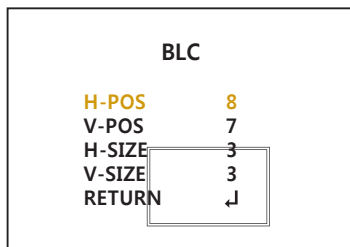

4-2. BLC (Backlight Compensation)

This function is used to brighten an image in the foreground with a highly light area behind it such as sunlight, limiting the affect of silhouette.

BLC has a target window for compensation and its size and position can be set by H-POS, V-POS, H-SIZE and V-SIZE.

4-2-1. H-POS, V-POS :

Sets the position of BLC area to move vertically and horizontally.

4-2-2. H-SIZE, V-SIZE :

Sets the size of BLC area to move vertically and horizontally.

Operating Instructions

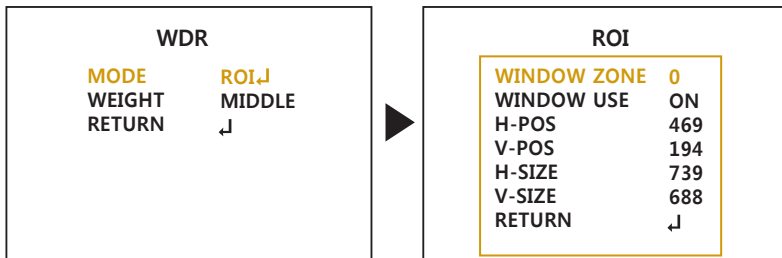

4-3. WDR (Wide Dynamic Range)

WDR is extended the gain range of the video that is mostly useful if camera takes a simultaneous picture of both indoor and outdoor nearby window. It improves contrast of the picture in outdoor scenery as well as indoor. Video outputs image processed from two images by dual shutter (long and short shutter) in a field to provide the best dynamic range. Highlight area is compensated by the short shutter and dark area is compensated by the long shutter. Final video may have less contrast compared to the conventional camera which does not have WDR function.

4-3-1. MODE : Selects WDR mode normal or ROI setting.

- NORMAL: WDR function applies full screen.
- ROI (Region Of Interest) : Sets specific area of WDR by window setting. Select window zone number from 0 to 3 and window use set to on. Then the window zone can be modified position and size.

4-3-2. WEIGHT : LOW, MIDDLE, HIGH

Selects the WDR value that you set the target area in MODE.

- ※ If CVBS video is enabled through ANALOG OUT0 or Sub-out port, WDR and 3D-NR functions are disabled in all video outputs. It should be considered when installer adjusts the video with installation monitor via CVBS video signal.

Operating Instructions

5. DAY & NIGHT

DAY/NIGHT is used to control the setting during day-time and night-time operation. Select the mode according to the light condition and the camera types.

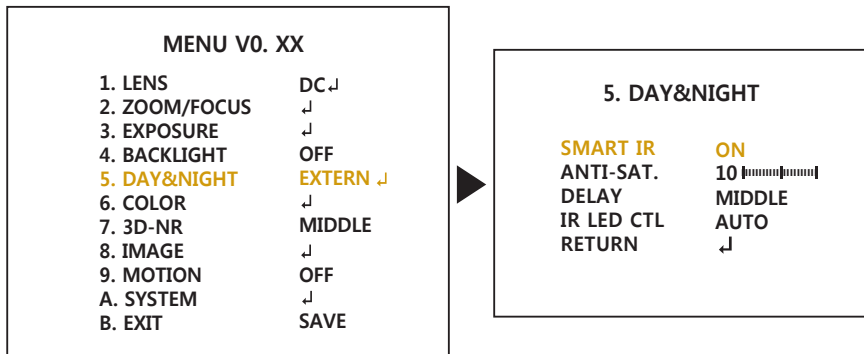

5-1. EXTERN

DAY or NIGHT is determined by the built-in light photo sensor.
Camera with IR LED must be set to EXTERNAL.

5-1-1. SMART IR

: SMART IR can be set to reduce the saturation by the strong IR illumination in the night in any menu of EXTERN, AUTO and B/W(NIGHT). Set to ON, SMART IR is enabled and ANTI-SAT. level is controlled.

5-1-2. ANTI-SAT. (Available only with the SMART IR is ON)

: Sets the anti saturation level 0~20. Setting high level avoids the saturation strongly but the corners will be darker accordingly.

5-1-3. DELAY

: D→N DELAY is time in second while camera maintains its status before Day to Night switches. DELAY can avoid the unwanted/frivolous switching by a short term lights such as light from the passing car. Sets delay term low, middle or high.

5-1-4. IR LED CTL

: IR LED Control(AUTO/OFF) is available with IR LED model only.
If it is set to OFF, IR LED will be turned OFF but DAY or NIGHT is still determined by the built-in light photo sensor.

Operating Instructions

5-2. AUTO

Used when DAY or NIGHT is determined by light level through the lens and DAY from/to NIGHT is switched automatically by the scene brightness.

It can be controlled the AGC threshold level, AGC margin and delay time.

5. DAY&NIGHT

SMART IR	ON
ANTI-SAT.	10
AGC THRES	10
AGC MARGIN	10
DELAY	MIDDLE
RETURN	↓

5-2-1. SMART IR

: SMART IR can be set to reduce the saturation by the strong IR illumination in the night in any menu of EXTERN, AUTO and B/W(NIGHT). Set to ON, SMART IR is enabled and ANTI-SAT. level is controlled.

5-2-2. ANTI-SAT. (Available only with the SMART IR is ON)

: Sets the anti saturation level 0~20. Setting high level avoids the saturation strongly but the corners will be darker accordingly.

5-2-3. AGC THRES

: AGC(Auto Gain Control) is a threshold level which determines to switch DAY from/to NIGHT in AUTO mode. Higher value makes the camera switch DAY from/to NIGHT at bright illumination.

5-2-4. AGC MARGIN

: Sets the gap level switching from/to DAY(color) or NIGHT(B/W).

5-2-5. DELAY

: D→N DELAY is time in second while camera maintains its status before Day to Night switches. DELAY can avoid the unwanted/frivolous switching by a short term lights such as light from the passing car. Sets delay term low, middle or high.

5-3. COLOR

The camera is always in COLOR mode.

Forcibly DAY/NIGHT is disabled and outputs color video.

5-4. B/W

The camera is always in B/W mode.

Forcibly removes IR cut filter and switches to B/W regardless of light level.

Operating Instructions

6. COLOR

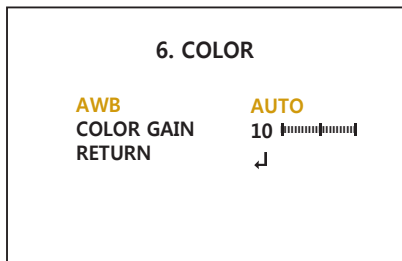

6-1. AWB (Auto White Balance)

Automatically tracks the changes of color temperature and continuously adjusts the white balance. AUTO, AUTOext, PRESET and MANUAL modes are available.

- 6-1-1. AUTO : Optimized for Indoor installation and more easily compensates AWB for low color temperature such as incandescent lights.
- 6-1-2. AUTOext : Optimized for outdoor sunlight applications and more easily compensates AWB for high color temperature such as sunlight.
- 6-1-3. PRESET : AWB is performed only whenever ● is pressed.
- 6-1-4. MANUAL : White balance is fixed to the settings by Color-Temperature Red-GAIN and Blue-GAIN. It can be used only when the color temperature does not vary.

6-2. COLOR GAIN

Sets the color gain control level 0~20.

Operating Instructions

7. 3D-NR (Digital Noise Reduction)

DNR function improves picture quality by filtering out signal noise which is generated under the low light conditions. Sets off, low, middle or high level. 3DNR(3-dimensional noise reduction) which reduces the noise by the multi frames. It is effective at low light. Setting high is strength of noise reduction but the result may occur in loss of sharpness and the tail effect of a comet.

MENU V0. XX	
1. LENS	DC ↓
2. ZOOM/FOCUS	↓
3. EXPOSURE	↓
4. BACKLIGHT	OFF
5. DAY&NIGHT	EXTERN ↓
6. COLOR	↓
7. 3D-NR	MIDDLE
8. IMAGE	↓
9. MOTION	OFF
A. SYSTEM	↓
B. EXIT	SAVE ↓

※ If CVBS video is enabled through ANALOG OUT0 or Sub-out port, WDR and 3D-NR functions are disabled in all video outputs. It should be considered when installer adjusts the video with installation monitor via CVBS video signal.

8. IMAGE

8. IMAGE	
SHARPNESS	↓
GAMMA	0.55
MIRROR	OFF
FLIP	OFF
ACE	OFF
DEFOG	OFF
PRIVACY	OFF
RETURN	↓

SHARPNESS	
MAIN OUTPUT	ANALOG OUT0
ANALOG OUT0	TVI MODE ↓
SDI&CVBS	5 []
CVI MODE	5 []
TVI MODE	6 []
AHD MODE	7 []
RETURN	↓

Operating Instructions

8-1. SHARPNESS

Sets the Sharpness level 0~10. Increases or decreases the sharpness of the picture. Too much sharpness can make image harsh and show more noise as well as line flicker at the edge of object in the picture.

8-2. GAMMA

Adjust gamma level of video.

8-3. MIRROR

The Video is reversed left and right if it turns ON.

8-4. FLIP

The Video is reversed upside down if it turns ON. When the video is flipped by Vertical, then the joystick directions are reversed accordingly. It is very useful when a camera is installed in upside

8-5. ACE

Improves the visibility for the high bright area and the dark area by compensating the video gain. Care should be taken to select low, middle or high level, because video may lose its quality in some environments by the over compensation. Video noise can be increased in the dark area accordingly.

8-6. DEFOG

Enhance the foggy video according to status of scene. Video quality can be less in normal environments. Sets AUTO or MANUAL mode.

8-6-1. MODE :

- AUTO : Enhance the foggy video automatically according to status of scene.
- MANUAL : Sets to enhance the foggy video manually regardless of status of scene.

8-6-2. LEVEL : Sets Low, Mid or High.

Video quality can be less in normal environments.

8-7. PRIVACY

Sets ON/OFF for enabling/disabling PRIVACY mask. 16 privacy areas are available and each area is programmable in size, color, position and transparency.



8-7-1. ZONE NUM : Selects mask zone number from 0 to 15 to be adjusted.

8-7-2. ZONE DISP: Displays OFF/ON for the mask area which you selected zone.

8-7-3. H-POS, V-POS :

Adjusts the mask area H, V position which you selected zone.

Operating Instructions

PRIVACY	
ZONE NUM	0
ZONE DISP	ON
H-POS	12
V-POS	2
H-SIZE	3
V-SIZE	3
Y-LEVEL	10 
CB LEVEL	10 
CR LEVEL	10 
TRANS	0
RETURN	↵

8-7-4. H-SIZE, V-SIZE :

Adjusts the mask size using H, V direction which you selected zone.

8-7-5. Y LEVEL : Adjusts the mask color by Y LEVEL. (0: black ~ 20: white)

8-7-6. CB LEVEL : Adjusts the mask color by CB LEVEL. (0: yellow ~20: blue)

8-7-7. CR LEVEL : Adjusts the mask color by CR LEVEL. (0: Green ~20: magenta)

8-7-8. TRANS.: Selects transparency rate for the mask area from 0 to 3

0 : Privacy mask is not transparent.

1 : Privacy mask is 25% transparent.

2 : Privacy mask is 50% transparent.

3 : Privacy mask is 100% transparent.

9. MOTION

4 motion detection areas are available and each area is programmable in size and location. The motion can be detected the changes in the motion areas and displays the results in blocks and/or a text message.

9-1. DET WINDOW : Sets the MOTION DETECTION areas on screen.

9-1-1. WINDOW ZONE : Set the detection zone number from 0 to 3.

9-1-2. WINDOW USE : Sets ON/OFF motion detection area which you selected.
If set to ON, It can be adjusted position and size.

9-1-3. DET H-POS, V-POS :
Adjusts the detection area H, V position which you selected zone.

9-1-4. DET H-SIZE, V-SIZE :
Adjusts the area size using H, V direction which you selected zone.

Operating Instructions

9. MOTION

DET WINDOW	↵
DET TONE	2
MDRECT FILL	ON
SENSITIVITY	5 
MOTION OSD	OFF
TEXT ALARM	OFF
RETURN	↵

DET WINDOW

WINDOW ZONE	0
WINDOW USE	ON
DET H-POS	1
DET V-POS	1
DET H-SIZE	58
DET V-SIZE	32
RETURN	↵

9-2. DET TONE

Sets the detection zone 0 to 4 display types which window use setting ON.

- 0 : Set the 100% opacity level of video background except detection window zone.
- 1 : Set the 50% opacity level of video background except detection window zone.
- 2 : Set the 25% opacity level of video background except detection window zone.
- 3 : Video background image is same as detection window zone.
- 4 : Detection window zone is displayed with box line

9-3. MDRECT FILL

Sets the motion display type when the motion is detected on video.

Setting ON is displayed red solid box type.

Setting OFF is displayed red outline box type.

9-4. SENSITIVITY

Sets the detection sensitivity for motion (0~10). High value increases the sensitivity to detect the small motion easily. Too low value will cause the erratic detection by the tree leaves or the light level changes.

9-5. MOTION OSD

Sets ON or OFF to display the motion results.

9-6. TEXT ALARM

Setting ON enables to display a text message 'WINDOWS MOVING!!' or icon when the motion is detected.

Operating Instructions

A. SYSTEM

Sets the system related functions.

A. SYSTEM	
OUTPUT	↓
RESOLUTION	1080 25P
TV SYSTEM	EU(PAL)
LANGUAGE	ENG
CAM TITLE	OFF
RESET	ON
RETURN	↓

OUTPUT	
SDI OUTPUT	HD-SDI
ANALOG OUT0	TVI MODE ↓
RETURN	↓

HD-ANALOG	
MAIN OUTPUT	ANALOG OUT0
ANALOG OUT0	TVI MODE
Y GAIN	16
CB GAIN	65
CR GAIN	68
POSITION	128
BURST FREQ	128
BURST GAIN	108
B&W	BURST ON
UTC TYPE	Pelco-C
720 EX	OFF
RETURN	↓

A-1. OUTPUT : Selects the main video output.

A-1-1. SDI OUTPUT :

Selects the SDI output HD-SDI, EX-SDI 1.0, EX-SDI 2.0, OFF

A-1-2. ANALOG OUT0 :

Selects HD-ANALOG modes TVI MODE, AHD MODE, CVI MODE or CVBS. It can be controlled Y-Gain, CB/CR-Gain, Position, Burst and etc.

Please set ANALOG OUT0 to TVI MODE, AHD MODE or CVI MODE if CVBS video is necessary through sub-out port.

If ANALOG OUT0 is set to CVBS, there is no CVBS video through sub-out port and sub-out port outputs CVBS video only.

Operating Instructions

- ※ If CVBS video is enabled through ANALOG OUT0 or Sub-out port, WDR and 3D-NR functions are disabled in all video outputs.
It should be considered when installer adjusts the video with installation monitor via CVBS video signal.

A-2. RESOLUTION

Select the video resolutions, 1080P/720P are available. 1080P outputs 1920x1080 video at the frame rate of 30P/25P. 720P outputs 1280x720 video at the frame rate of 60P/50P.

A-3. TV SYSTEM

Selects HDTV standards for analog video output switches to 60HZ, US(NTSC) or 50HZ, EU(PAL) accordingly.

A-4. LANGUAGE

6 languages are available for OSD menu.
English, Chinese, Chinese(S), Japanese, Korean, German.

A-5. CAM TITLE

Camera title(name) can be set and edited with alphanumeric characters. Select the camera title position 'LEFT DOWN' or 'RIGHT UP' on the video. Then ◀, ▶ moves the cursor and ▲, ▼ choose a character to select it. The selected characters are added and displayed on the input line.

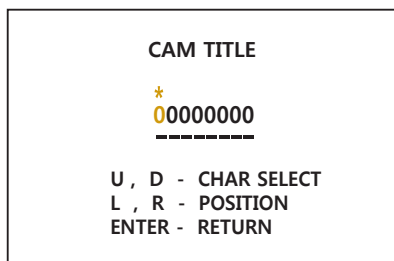

A-6. RESET : Loading Factory Default.

B. EXIT : Exits SETUP MENU and returns to the normal display.

B-1. SAVE : Save all the setting and exit the setup menu.

B-2. CANCEL : Exit the setup menu without save.

Specifications

ITEM	MPD-62M2812P0A
Imaging Sensor	1/2.8" Sony 2Mega pixel STARVIS CMOS Sensor
Effective Pixels	1920(H) x 1080(V) x 25p
Scan Frequency	25Hz(V), 18.75KHz(H) / Progressive
Video Format	HD] 16:9, 1080p@25fps ----- CVBS] 16:9 (PAL)
Synchronization	Internal
Video Output	EX-SDI1.0, 2.0 /HD-SDI / TVI mode/ AHD mode/ CVI mode/ CVBS
Video Resolution	1920x1080 (30p/25p)
Min.Illumination	Color: 0.08 Lux (LED Off), B/W: 0.005 Lux (LED Off)
S/N Ratio	More than 50dB (AGC Off)
Lens	f=2.8~12mm F1.4 5Mega pixel Motorized zoom vari-focal lens
LEDs	2pcs x 850nm High power LEDs
Exposure	Brightness / Shutter / Sens-up / AGC
DAY / NIGHT	TDN by dual filter switcher, EXTERN / AUTO / COLOR / B&W
Auto White Balance	AUTO / AUTOext / PRESET / MANUAL
WDR	True WDR by dual scan images in two frames at 30fps/25fps
ROI-WDR	Yes
DNR	3D-NR
Functions	ACE(D-WDR), Motion Detection, Privacy Mask, Defog, Sharpness, Sens-up(~x32), Mirror/Flip, BLC/HLC, Smart IR, Deblur, Title Set, Anti-Saturation
Remote Control	UTC by HD-TVI (Pelco-C, Hikvision) / AHD
OSD Language	English, Korean, Japanese, Chinese(S) / Chinese, German
Video Output	VBS 1Vp-p \pm 10%, 75 Ω
Operating Temp.	-10°C ~ +50°C (Humidity: 20%RH ~ 80%RH)
Operating Power	DC12V, Circuit protection against faulty connection in power polarity.
Housing	Double side Anti-scratch Hard coated clear bubble, 3-Axis gimbal, Easy Installation Adaptor (Flat or Tilted adaptor)
Dimensions	Ø116mm(W) x 94mm(H)_ Bubble: Ø80 / About: 260g

(*) Design and specifications are subject to change for product improvements without prior notice.



eneo® is a registered trademark of
Videor E. Hartig GmbH
Exclusive distribution through special-
ised trade channels only.

Videor E. Hartig GmbH
Carl-Zeiss-Straße 8
63322 Rödermark/Germany
Tel. +49 (0) 6074 / 888-0
Fax +49 (0) 6074 / 888-100
www.videor.com
www.eneo-security.com

Technical changes reserved

© Copyright by Videor E. Hartig GmbH
Version 06/2017